



Desktop Audio System

TSX-B237

EN Owner's Manual

Table of contents

Introduction	3	Useful features	22
Accessories	3	Shuffle/repeat playback	22
About this document	3	Playback information	23
Using the unit	4	Adjusting sound quality	24
Part names	5	Registering favorites with SCENE	25
The unit	5	Alarm (IntelliAlarm)	26
Display	6	Child lock function	29
Remote control	7	Charging a mobile device (Qi)	30
Preparation	9	Adjusting display brightness (dimmer)	31
Turn on the unit	9	Option settings	32
Set the unit's clock	10	Troubleshooting	34
Using the sleep timer	10	Messages in the display	40
Play from an input source	11	Devices/media, and file formats supported by the unit	41
Listening to an audio CD	11	Specifications	43
Listening to music via Bluetooth®	12		
Listening to DAB stations (Australia model only)	15		
Listening to FM radio stations	18		
Listening to music on USB flash drives	20		
Listening to music from an external device	21		

Thank you for purchasing this Yamaha product.
Before using the unit, be sure to read this document and the supplied "Safety Brochure" to ensure proper and safe use. Keep these documents readily available for future reference.

Introduction

Confirm package contents and important information about this manual.

Accessories



Remote control



Non-skid pad (☞ p. 30)

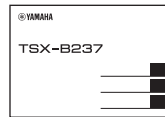

Quick Manual

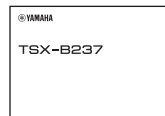

Safety Brochure

About this document

- This document provides detailed instructions on operating all of the unit's functions.
- Instructions concentrate on use of the remote control to operate the unit.
- Illustrations are provided for reference purposes only, and should not be considered completely accurate in every case.
- In this document, smartphones and other mobile devices running the iOS or Android operating systems are collectively referred to as "mobile devices".
- Screenshots in this document were captured on a device running the English version of iOS. Actual screen displays may differ depending upon the version of the app or iOS used.

- Symbols and conventions



This content indicates "risk of serious injury or death."

Notice

Indicates points that you must observe in order to prevent product failure, damage or malfunction and data loss, as well as to protect the environment.

Note

Indicates notes on instructions, restrictions on functions, and additional information that may be helpful.



References another page or pages that provide additional information.

Using the unit

- This unit is a desktop audio system that can play audio from an incredibly wide range of input sources, including CDs, Bluetooth devices, and radio stations.
- This unit is equipped with a convenient charging function and an alarm function that wakes you gently.
- The free dedicated Multimedia Music Controller app for mobile devices can be used to easily control playback or configure the unit's settings. Download the Multimedia Music Controller app to your mobile device from the App Store or Google Play.

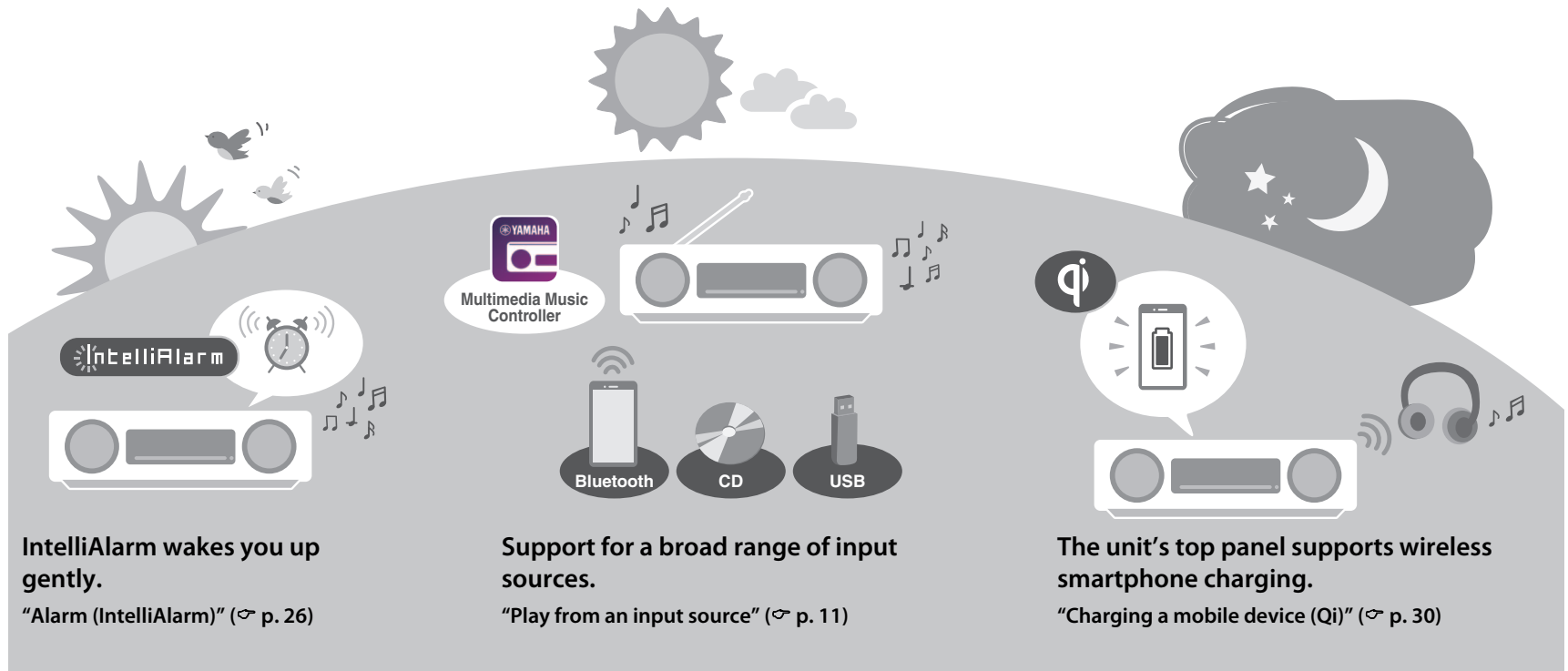

Part names

The unit

①, ②, ③, ⑥, and ⑦ are touch sensors. Tap icons with your finger to control functions.

Top /front panels

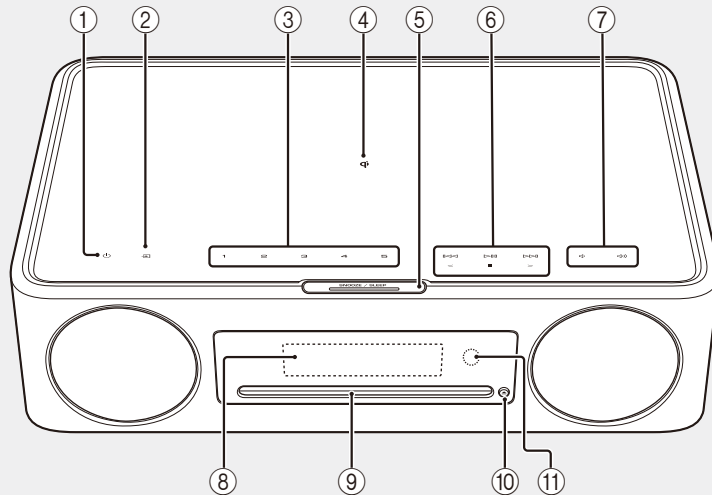

Rear panel

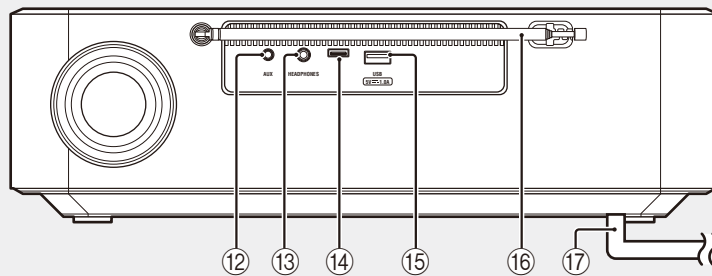

- ① Turn the unit on/off (standby) (☞ p. 9).
- ② Switch the input source.
- ③ **1, 2, 3, 4, 5** SCENE function (☞ p. 25)
- ④ Wireless charger (☞ p. 30)
- ⑤ SNOOZE/SLEEP (☞ p. 10, 26)
- ⑥ Control audio (☞ p. 11).
- ⑦ Volume +/-
- ⑧ Display (☞ p. 6)
- ⑨ Disc slot (☞ p. 11)
- ⑩ Eject a disc (☞ p. 11).
- ⑪ Remote sensor (☞ p. 9)
- ⑫ AUX jack (Mini jack input) (☞ p. 21)
- ⑬ HEADPHONES jack
No sound is heard from the unit when the headphones are connected.
- ⑭ Service jack
Use when the unit requires maintenance.
- ⑮ USB jack (☞ p. 20)
- ⑯ FM antenna (☞ p. 18)
FM/DAB antenna (Australia model only) (☞ p. 15)
- ⑰ Power cord (☞ p. 9)

Display

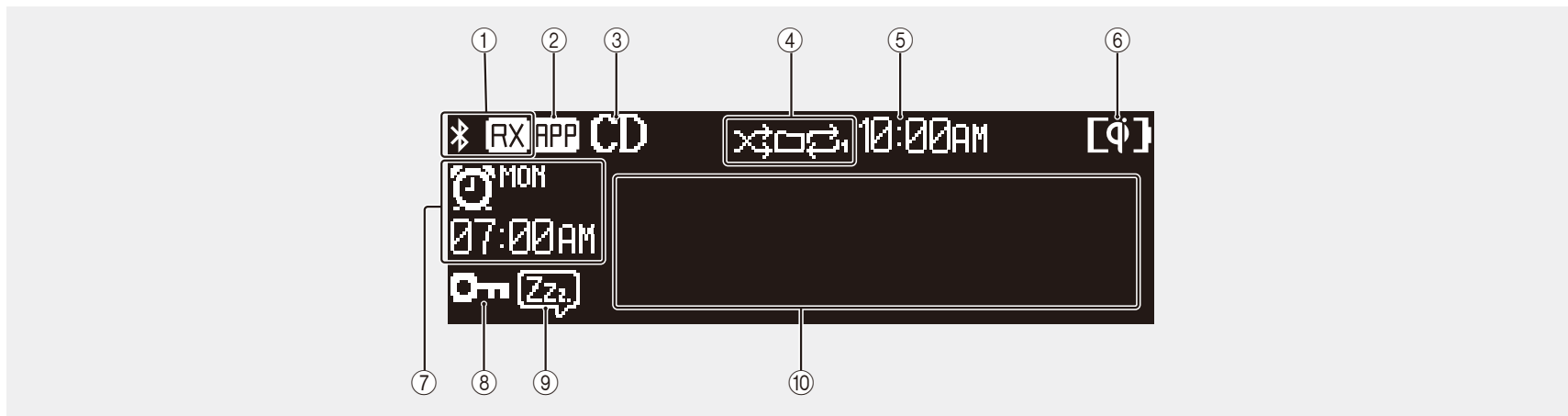

- ① Bluetooth indicators (☞ p. 12)
- ② App (Multimedia Music Controller app) indicator
The indicator is displayed when the app is in use.
- ③ Input source indicator
The selected input source is displayed.
- ④ Shuffle and repeat indicators (☞ p. 22)
- ⑤ Current time
- ⑥ Qi wireless charging indicator (☞ p. 30)
- ⑦ Alarm indicators (☞ p. 26)
- ⑧ Child lock indicator (☞ p. 29)
- ⑨ Sleep indicator (☞ p. 10)
- ⑩ Multi display
Displays a variety of information, including that for a song as it plays, radio frequency, etc.
Some information may be cut off as there is a limit on the number of characters that can be displayed.

Note

Display brightness can be adjusted as required.

- Auto (default setting; adjusted automatically in accordance with ambient lighting.)
- Manual (10 levels)

See "Adjusting display brightness (dimmer)" (☞ p. 31) to configure this function.

Remote control

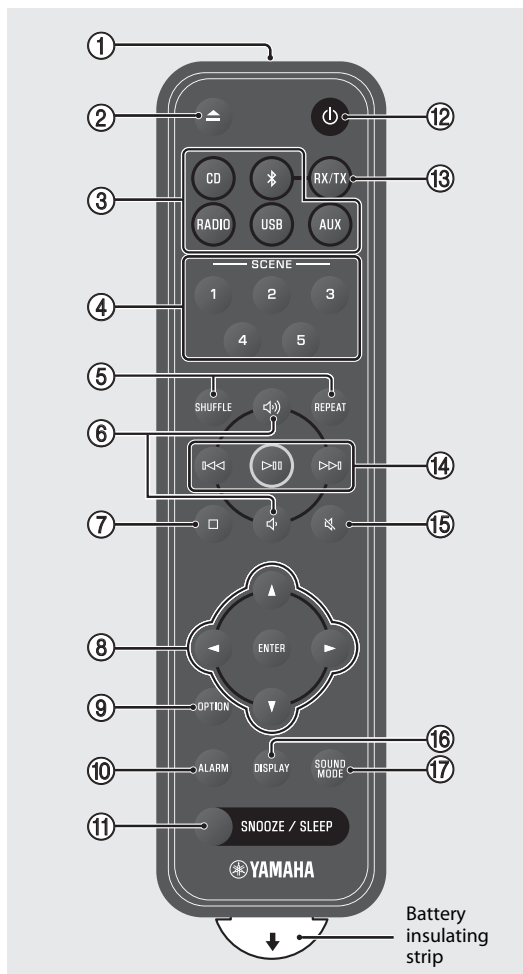

- ① Transmit infrared (IR) signals (☞ p. 9).
- ② ▲ Eject a disc (☞ p. 11).
- ③ Input source buttons (☞ p. 11)
Switch the input source.
- ④ SCENE function (☞ p. 25)
- ⑤ SHUFFLE/REPEAT (☞ p. 22)
- ⑥ 🔊/🔇 Volume +/-
- ⑦ □ Stop playback (☞ p. 11, 20).
- ⑧ Cursor control buttons (☞ p. 10)
- ⑨ OPTION (☞ p. 32)
- ⑩ ALARM (☞ p. 26)
- ⑪ SNOOZE/SLEEP (☞ p. 10, 26)
- ⑫ ⏻ Turn the unit on/off (standby) (☞ p. 9).
- ⑬ RX/TX
Switch between receiving and transmitting audio functions of Bluetooth.
(Receiving audio ☞ p. 12, transmitting audio ☞ p. 13)
- ⑭ Audio control buttons (☞ p. 11)
- ⑮ 🔇 Mute/unmute
- ⑯ DISPLAY (☞ p. 23)
- ⑰ SOUND MODE (☞ p. 24)

Remove the battery insulating strip before attempting to use the remote control.

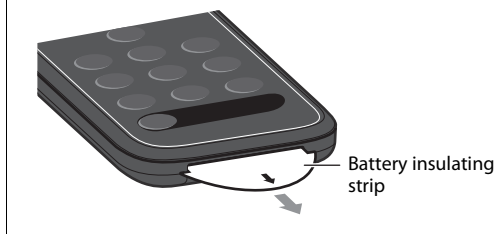

Replacing the remote control battery

Press the release tab firmly to the right and hold it there while slowly sliding the battery holder out.

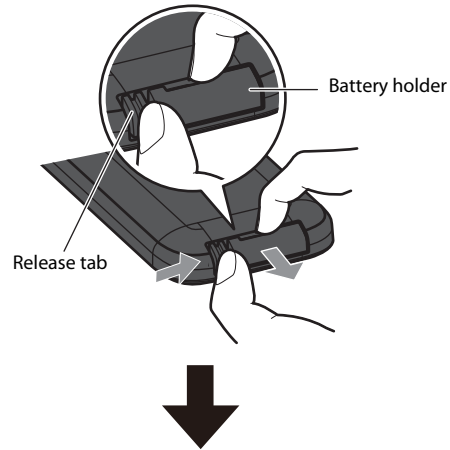

Replace the old battery with a new one.

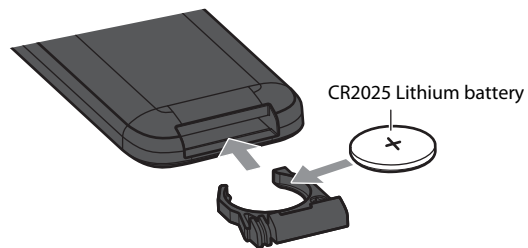

Note

Replace the old battery with a new one when the remote control's range becomes very short.

Turn on the unit



- 1 Plug the power cord into an electrical outlet.

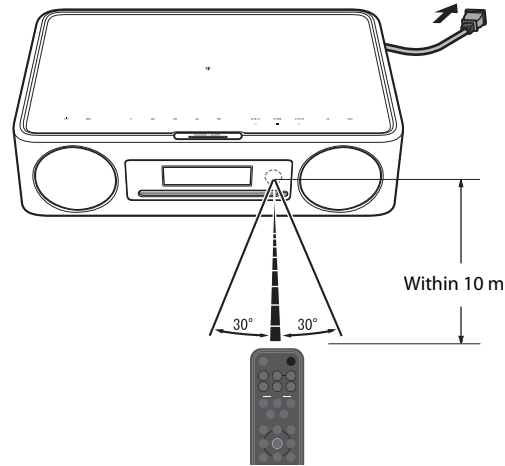

- 2 Press  to turn on the unit.

The display on the unit's front panel will be turned on.

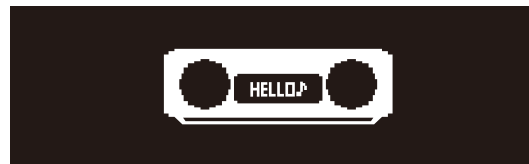

Reducing power consumption

Auto power standby (default: ON)

The unit will automatically enter auto power standby mode to reduce power consumption in any of the following situations:

- CD, BLUETOOTH, or USB is selected as the input source, but no audio is played and no operations are performed for more than 20 minutes.
- An input source other than any of those noted above is selected, but no operations are performed for more than 8 hours.

See "Option settings" ( p. 32) to disable the auto power standby function.

Eco standby (default: OFF)

Eco standby mode minimizes power consumption. The following features are not available in eco standby mode.

- Bluetooth
- Qi/USB charging functions

See "Option settings" ( p. 32) to enable the eco standby function.



With an advanced energy saving design, this product achieves a low power consumption of not more than 1.8 watts when in standby mode.



Set the unit's clock

1 Press **OPTION**.

The option menu is displayed.



2 Use **◀/▶** to select and press **ENTER**.

3 Use **▲/▼** to select **Clock Setting** and press **ENTER**.

4 Use **▲/▼/◀/▶** to adjust the date and time.

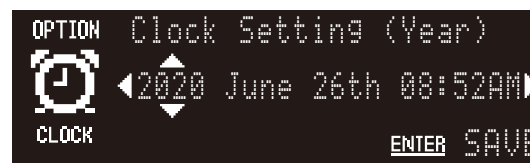

5 Press **ENTER** to finalize and apply clock settings.

Note

Press **DISPLAY** while setting the clock to switch between a 12- and 24-hour time.

Using the sleep timer

The unit automatically enters standby mode when the specified time has elapsed. The time can be selected from 30, 60, 90, or 120 minutes, or the sleep timer can be disabled (OFF).

Press **SNOOZE/SLEEP**.

The time selected changes each time **SNOOZE/SLEEP** is pressed. The sleep indicator is displayed when the sleep timer is set.



Note

To cancel the sleep timer, press **SNOOZE/SLEEP**.

Play from an input source

Listening to an audio CD

1 Press **CD**.

2 Insert a CD into the disc slot.

Music begins playing. Press ▲ to eject a CD.

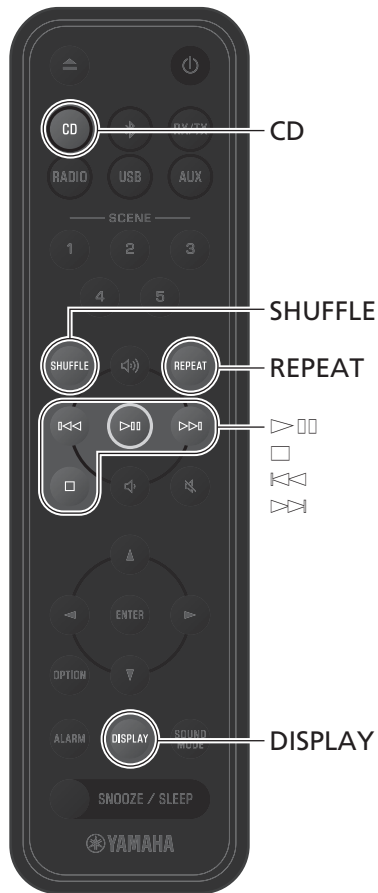
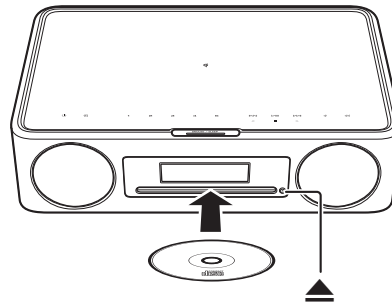

Note

- This unit supports playback of audio and data CDs to which MP3 and or WMA files have been recorded.
- Music files stored on a data CD can be played using the same operations used to play music stored on a USB flash drive (☞ p. 20).
- This unit does not support 8-cm mini CDs. Do not insert an 8-cm mini CD, or an adapter containing an 8-cm mini CD, into the disc slot.
- If a CD that is not supported by the unit is inserted into the disc slot, it may not be possible to eject the CD. See “Devices/media, and file formats supported by the unit” for information on CDs supported by the unit (☞ p. 41).
- When CD playback is stopped, playback will resume from the beginning of the song last played. Pressing □ while playback is stopped will clear playback memory (resume playback feature).
- If the unit is turned off when CD has been selected as the input source and a CD has been inserted into the disc slot, CD playback will automatically begin the next time the unit is turned on.

Audio control buttons

▷◻	Play/pause
◻	Stop
◀◀	Skip to the beginning of the song being played or previous song. Press and hold to fast rewind.
▶▶	Skip to the next song. Press and hold to fast forward.
DISPLAY	Information about an audio CD being played is displayed. (☞ p. 23)
SHUFFLE/ REPEAT	☞ p. 22

Listening to music via Bluetooth®

The unit can be used to play music from a Bluetooth device, such as a mobile device or digital music player. In addition, Bluetooth wireless headphones or speakers can be used to listen to audio played via the unit.

For more information regarding Bluetooth, see documentation provided with Bluetooth devices.

Note

- A Bluetooth device that transmits audio to the unit and Bluetooth speakers/headphones that receive audio from the unit cannot be connected at the same time.
- If a Bluetooth device has been connected before, the unit will connect to the last connected device. Terminate this connection to connect a new device.
- Press  for at least three seconds to terminate the Bluetooth connection on the unit.

Listening to music from a Bluetooth device (Receiving)

Audio from a Bluetooth device can be played on the unit over a wireless connection.

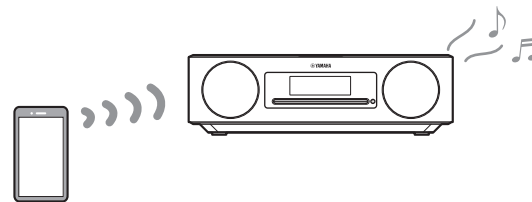

1 Enable the Bluetooth function of the Bluetooth device.

2 Press .

The unit's input source is switched to Bluetooth.

3 Select this unit from the Bluetooth device list on the Bluetooth device.

The Bluetooth indicators will be displayed once the connection has been established.



4 Play a music file on the Bluetooth device.

Note

If a Bluetooth connection is not established, delete the unit's registration from the Bluetooth device, and then try to repeat steps **2-3**.

Using Bluetooth speakers/headphones to listen to audio (transmitting)

Bluetooth speakers or headphones can be used to listen to audio played via the unit.

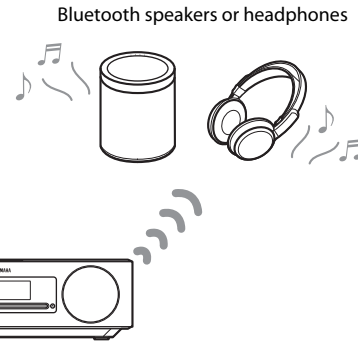

Note

- This function cannot be used when Bluetooth is selected as the input source. Select an input source other than Bluetooth.
- Be sure to use Bluetooth speakers or headphones that are equipped with a volume control. Volume must be adjusted using the Bluetooth speakers or headphones. Volume cannot be adjusted from this unit.
- Use the volume control on the Bluetooth speakers or headphones to turn down the volume, and then connect the speakers or headphones to the unit. Failure to turn down the volume before connecting may result in extremely loud playback to begin when the Bluetooth connection is established.



- 1 Set Bluetooth speakers or headphones to pairing mode.
- 2 Press **OPTION** on the remote control.
- 3 Use ◀/▶ to select  , and press **ENTER**.
- 4 Use ▲/▼ to select **Bluetooth TX**, and press **ENTER**.
- 5 Use ▲/▼ to select **ON**, and press **ENTER**.

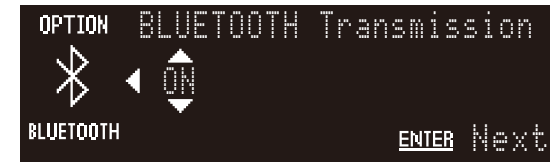

- 6 Press **ENTER**.
Bluetooth speakers or headphones that can be connected to the unit will be detected and displayed.



7 Select the Bluetooth speakers or headphones to be connected and press **ENTER**.

The Bluetooth indicators will be displayed when the Bluetooth connection is established.



8 Select an input source on the unit and play audio from that source.

Note

- If a Bluetooth connection is not established, repeat the connection procedure from step **1**.
- If Bluetooth speakers or headphones have been previously connected to the unit, the unit will connect to the last connected device when **RX/TX** is pressed to apply TX (transmitting) mode.
- Audio is not output from the unit in TX (transmitting) mode.
- RX (receiving) mode is automatically applied when the unit is in standby mode.

Listening to DAB stations (Australia model only)



Initial scan

Press **RADIO** repeatedly to select **DAB**.

- Initial scan starts automatically when you select **DAB** for the first time.
- When scanning is completed, the number of receivable DAB stations is displayed momentarily, and the first station stored is played.

Tuning in DAB stations

1 Press **RADIO** repeatedly to select **DAB**.

When the unit cannot receive the DAB signal, "Off Air" is displayed.

2 Press ◀ or ▶ to select a DAB station.

Note

- Initial scan can also be performed from the option settings.
 - 1 Press **OPTION** when **DAB** is selected as the input source.
 - 2 Use ◀/▶ to select **DAB** and press **ENTER**.
 - 3 Use ▲/▼ to select **Initial Scan** and press **ENTER**.
The initial scan display is shown.
 - 4 Press **ENTER** to begin the initial scan.
"Completed!" is displayed when the initial scan is complete.
- If an initial scan is performed, stored DAB station information and preset DAB stations are cleared.
- This unit can receive only Band III DAB frequencies.

Frequency in MHz/Channel label

174.928/5A	176.640/5B	178.352/5C	180.064/5D
181.936/6A	183.648/6B	185.360/6C	187.072/6D
188.928/7A	190.640/7B	192.352/7C	194.064/7D
195.936/8A	197.648/8B	199.360/8C	201.072/8D
202.928/9A	204.640/9B	206.352/9C	208.064/9D
209.936/10A	211.648/10B	213.360/10C	215.072/10D
216.928/11A	218.640/11B	220.352/11C	222.064/11D
223.936/12A	225.648/12B	227.360/12C	229.072/12D
230.784/13A	232.496/13B	234.208/13C	235.776/13D
237.488/13E	239.200/13F		

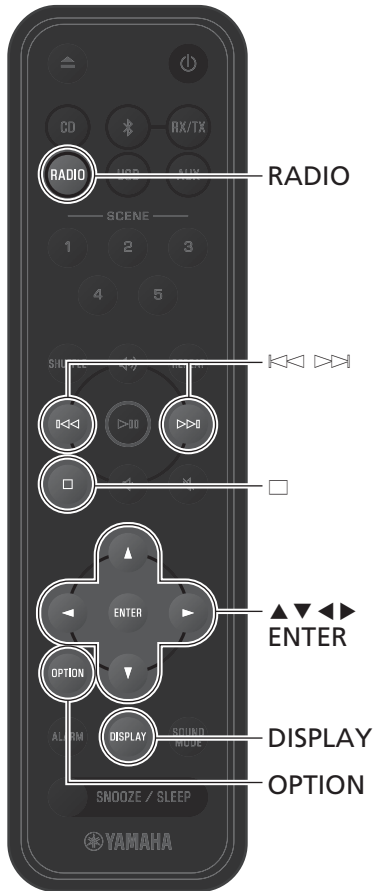

Presetting DAB stations

Use the preset function to store your favorite 40 DAB stations.

- 1** Tune in to a DAB station (↪ p. 15).
- 2** Press and hold **ENTER**.
The preset setting is displayed.
- 3** Press ▲/▼ to select the required preset number, and press **ENTER**.
To cancel the DAB preset setting, press □.

Selecting preset DAB stations

- 1** Press **RADIO** repeatedly to select **DAB**.
- 2** Press ◀/▶ to select a preset station.

Note

DAB station information shown in the display is switched in the following order each time **DISPLAY** is pressed.

DLS (Dynamic Label Segment) (default)

Ensemble Label

Channel Info (Channel label and frequency)

Signal Quality

Audio Format

Deleting a preset DAB station

- 1** Press **OPTION** when **DAB** is selected as the input source.
- 2** Use ◀/▶ to select  and press **ENTER**.
- 3** Use ▲/▼ to select **Preset Delete** and press **ENTER**.
- 4** Use ▲/▼ to select the preset number to be deleted or **ALL**, and press **ENTER**.
A confirmation dialog is displayed. Press **ENTER** to delete the preset station.
- 5** Press **OPTION** to exit the settings display.



Confirming the reception

You can confirm the DAB signal level. This is useful when setting up the antenna.

- 1 Press **OPTION** when **DAB** is selected as the input source.
- 2 Use **◀/▶** to select  and press **ENTER**.
- 3 Use **▲/▼** to select **Tuning Aid** and press **ENTER**.

The Tuning Aid display is shown.

- 4 Press **ENTER**.
 - 5 Press **▲/▼** to change the channel label.
- The measured DAB signal reception level is displayed.



The level is from 0 (none) to 100 (best).

- 6 Press **OPTION** to exit the settings display.

Note

When the DAB signal is weak in Tuning Aid, try adjusting the position of the antenna to obtain good reception.

Listening to FM radio stations

Extend the antenna and position it for good FM reception.



Tuning in to a station

- 1 Press **RADIO**.
- 2 Press and hold **◀** or **▶**.

Automatic tuning starts. Tuning will stop automatically when a station is tuned in.



Note

If station reception is weak, tune in to a station manually by pressing **◀/▶** repeatedly. Sound will be heard in monaural.

Presetting stations

Auto preset

The unit tunes in stations with good reception and presets them automatically.

- 1 Press **RADIO**.
- 2 Press **OPTION**.
- 3 Use **◀/▶** to select  and press **ENTER**.
- 4 Use **▲/▼** to select **Auto Preset** and press **ENTER**.

The auto preset display is shown.

- 5 Press **ENTER** to begin the auto preset.

"Completed!" is displayed when the auto preset is complete.

Note

- Auto preset replaces all stations currently stored with new stations.
- Up to 40 FM stations can be preset.
- Press **OPTION** to cancel auto preset.



Manual preset

- 1 Tune in to a station (🔗 p. 18).
- 2 Press and hold **ENTER**.
The preset setting is displayed.



- 3 Press **▲/▼** to select the required preset number, and press **ENTER**.

Note

Press  to cancel manual preset.

Selecting a preset station

- 1 Press **RADIO**.
- 2 Press **◀◀/▶▶** to select a preset station.

Deleting a preset station

- 1 Press **RADIO**.
- 2 Press **OPTION**.
- 3 Use **◀/▶** to select  and press **ENTER**.
- 4 Use **▲/▼** to select **Preset Delete** and press **ENTER**.
- 5 Use **▲/▼** to select the preset number to be deleted or **ALL**, and press **ENTER**.
The confirmation dialog is displayed. Press **ENTER** to delete the preset station.
- 6 Press **OPTION** to exit the settings display.

Listening to music on USB flash drives

- 1 Press **USB**.
- 2 Connect a USB flash drive to the USB jack.

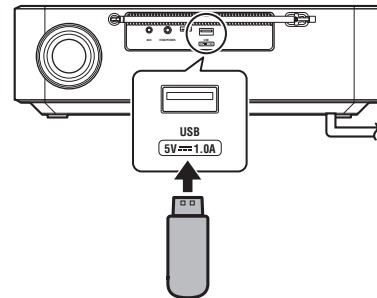

- 3 Play a song.

Use the following buttons to play a song.

▲/▼	Select a folder.
⏮	Skip to the beginning of the song being played or previous song. Press and hold to fast rewind.
⏭	Skip to the next song. Press and hold to fast forward.
▶⏸	Play/pause
⏹	Stop
SHUFFLE/ REPEAT	☞ p. 22
DISPLAY	Information about content being played is displayed. (☞ p. 23)

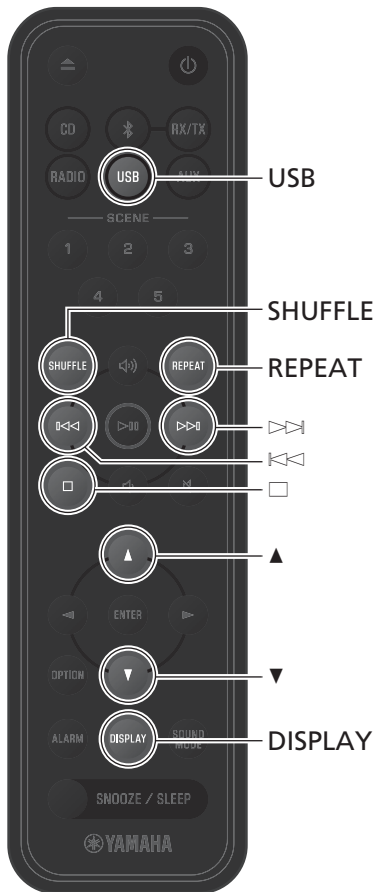

Note

- Music files stored on USB flash drives can be played via the unit. See “Devices/media, and file formats supported by the unit” for information on USB flash drives supported by the unit (☞ p. 42).
- Some USB flash drives may not work properly even if they meet the requirements. Playability of and power supply to all USB flash drives are not guaranteed.
- Stop playback before disconnecting the USB flash drive.
- A USB flash drive is automatically charged as long as it is connected to the unit except when the unit is in eco standby mode. However, some devices may not charge when connected. See “Option settings” to disable the charge function (☞ p. 32).
- Connect a USB flash drive directly to the USB jack of the unit. Do not use extension cables.

Listening to music from an external device

Music played on an external device connected to the AUX jack on the unit's rear panel can be heard through this unit. See documentation supplied with the external device for more information.



- 1** Unplug the power cord from the electrical outlet, and connect the external device to the unit.

Use cables sold separately for connections.

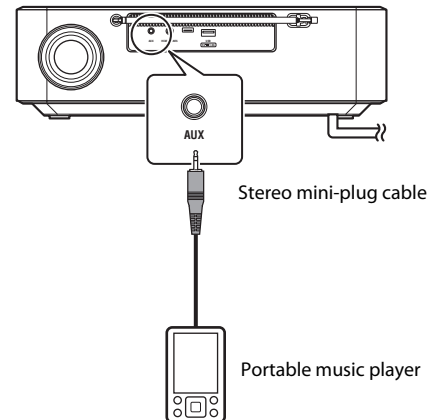

- 2** Plug the power cord into an electrical outlet, and turn on the unit.
- 3** Press **AUX**.

- 4** Play the external device connected to the unit.

Note

Lower the volume sufficiently on the unit and external device before connection. Otherwise, the volume may be unexpectedly loud when music begins playing.

Useful features

Features such as shuffle and repeat playback, display of song information, and a SCENE function make this unit even more convenient and enjoyable to use.

Shuffle/repeat playback

Press **SHUFFLE** or **REPEAT** during playback.

The indicators will change each time **SHUFFLE** or **REPEAT** is pressed, and songs will play as follows.



Shuffle playback

Shuffle indicators	Media	
	Data CD/USB	Audio CD
Shuffle all songs	Shuffle all songs	Shuffle all songs
Shuffle all songs in a folder	Shuffle all songs in a folder	—
Goes off	The shuffle function is not applied.	The shuffle function is not applied.

Repeat playback

Repeat indicators	Media	
	Data CD/USB	Audio CD
Repeat all songs	Repeat all songs	Repeat all songs
Repeat all songs in a folder	Repeat all songs in a folder	—
Repeat the song being played.	Repeat the song being played.	Repeat the song being played.
Goes off	The repeat function is not applied.	The repeat function is not applied.

Playback information

While content from an audio CD, data CD or USB flash drive is being played, information such as playing time can be shown in the display.

Press **DISPLAY** during playback.

The display switches each time **DISPLAY** is pressed.

Audio CD

Display	Information
PlayTime	Playing time of the song
Track Remaining Time	Remaining time of the song
Total Remaining Time	Remaining time of the disc

Data CD/USB

Display	Information
PlayTime	Playing time of the file
Song	Song name
Artist	Artist name
Album	Album name
File Name	_____
Folder Name	_____

Note

Information such as the album title may not be properly displayed for songs played from some types of media.



Adjusting sound quality

Adjust audio parameters as needed to suit individual preferences.

Adjusting tones

Adjust the level at which low, middle, and high tones are output.

Note

Press **OPTION** to cancel setup before it is completed.

- 1 Press **OPTION**.
- 2 Use **◀/▶** to select  and press **ENTER**.
- 3 Use **▲/▼** to select **EQ Setting** and press **ENTER**.
- 4 Adjust low, middle, and high tones.



Use **▲/▼** to change the level. Use **◀/▶** to select another tone. Press **ENTER** to complete setup.

Default: 0

Adjustable level: -10 to +10

- 5 Press **OPTION** to exit the settings display.

Selecting the sound mode

Two sound modes are available—Bass Boost and Standard.

- Bass Boost (default)
Best for music
- Standard
Best for human voices (talk radio, etc.)



Registering favorites with SCENE

Favorite songs and radio stations can be assigned to the SCENE (1 to 5) buttons. Once registered, favorites can easily be selected for listening.



Registering favorites

Press and hold one of the SCENE buttons while the input source to be registered is playing.

The song or radio station that is playing will be assigned to that SCENE button.



Listening to favorites

Press the SCENE button to which a favorite song or radio station has been assigned.

- The song or radio station assigned to that SCENE button will play. When the SCENE button is pressed in standby mode, the unit will be turned on and playback will begin.
- Individual songs stored on a Bluetooth or other external device cannot be assigned to SCENE buttons. The Bluetooth or other external device will be selected as the input source by pressing the SCENE button to which it has been assigned.

Note

- When a favorite is registered with a SCENE button to which another favorite was previously assigned, the new favorite will replace the previous favorite.
- If a CD not registered with a SCENE button is placed in the unit, or a USB flash drive not registered with a SCENE button is connected to the unit, the first song on that CD or USB flash drive will play when a SCENE button is pressed.

Alarm (IntelliAlarm)

Five alarm options—music, beeps, combination of music and beeps—are available. A CD, a USB flash drive, or a radio station can be selected as the source of music used as the alarm (alarm source).

Alarm type

Music only (Source)

Music begins playing at the specified time.
Music begins playing at low volume one minute prior to the specified time, increasing to the specified volume at the specified time.

Music + beeps (Source + BEEP)

Music begins playing at the specified time and beeps begin sounding at the same time.
Music begins playing at low volume three minutes prior to the specified time, increasing to the specified volume at the specified time. Beeps begin sounding over the music at the specified time.

Beeps only (BEEP)

Beeps begin sounding at the specified time.

Alarm sources (CD, USB flash drive, and radio station)

The following types of playback can be selected according to the alarm source.

Note

Be sure to place a CD in the unit, or connect a USB flash drive to the unit, when using either as the alarm source. If the proper alarm source is not available, music will not play, and only beeps will sound when the alarm is triggered.

CD

- **Specified song:** Play the specified song repeatedly.
- **Resume playback:** Play from the last song played.

Note

“Resume playback” is applied to data CDs even when “Specified song” is selected.

USB

- **Specified song:** Play the specified music file from the specified folder repeatedly. Name the folder and file(s) as follows to use them as alarm sources

Folder name: “ALARM”

File name: “01” to “99” (for example, when an mp3 file is named “01”, the file name is “01.mp3”).

Note

If the ALARM folder contains files of the same name but different extensions, such as “01.mp3” and “01.wav”, the specific file to be used cannot be selected.

- **Resume playback:** Play from the last music file played.

Radio station

- **Specified radio station:** Select from preset stations to play (☞ p. 16, 18).
- **Resume playback:** Play the radio station last received.



Setting the alarm

1 Press **ALARM**.

The alarm setup display in the option settings is shown.

Note

Press **OPTION** to close the alarm display while setting the alarm.

2 Use ▲/▼ to select the alarm number (1 to 5).

3 Use ► to move the cursor and then use ▲/▼ to select **ON**.



4 Press **ENTER**.

5 Configure the alarm function.

Use ▲/▼ to select the item and then press **ENTER** to complete setup.

- ① Hour and minute
- ② Alarm type (☞ p. 26)
- ③ Alarm source (☞ p. 26)
- ④ Playback type (☞ p. 26)
- ⑤ Repeat (Day of the week can be specified using the Multimedia Music Controller app.)
- ⑥ Volume

6 Press **OPTION** to exit the settings display.

The alarm indicator is displayed.





Turning on and off the alarm

- 1** Press **ALARM**.
The alarm display in the option settings is shown.
- 2** Use ▲/▼ to select the alarm number.
- 3** Use ► to move the cursor and then use ▲/▼ to select **ON** or **OFF**.
- 4** Press **OPTION** to exit the settings display.

When the alarm is turned on, the alarm indicator is displayed.

Stop the alarm

Stop the alarm temporarily

Press **SNOOZE/SLEEP** while the alarm is sounding to stop the alarm. The alarm stops temporarily and begins sounding again five minutes later (snooze function).

Note

When **Source + BEEP** is selected as the alarm type, pressing **SNOOZE/SLEEP** while the alarm is sounding will stop only the beeps. Press **SNOOZE/SLEEP** again to stop the music as well. Note that the alarm will sound again five minutes later.

Stop the alarm completely

Press and hold **SNOOZE/SLEEP** or press **ALARM** once while the alarm is sounding to stop the alarm completely.

Note

If the alarm is not stopped manually, it will stop automatically after 60 minutes have passed.

Child lock function

The child lock function disables operations from the controls on the unit to prevent unintended or accidental operation. This function is disabled by default. When the child lock function is enabled, only the following functions can be operated via the controls on the unit. Use the remote control or app to operate other functions.

- turn on the unit/set the unit to standby mode
- stop the alarm

Enabling/disabling the child lock function

- 1 Press **OPTION**.
- 2 Use **◀/▶** to select  and then press **ENTER**.
- 3 Use **▲/▼** to select **Child Lock** and then press **ENTER**.



- 4 Use **▲/▼** to select **ON** and then press **ENTER**.

- 5 Press **OPTION** to exit the settings display.

The child lock indicator is displayed.

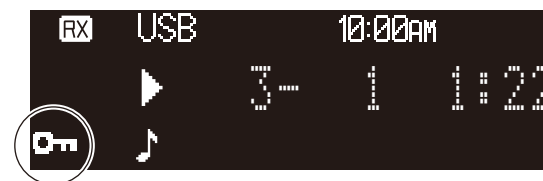

Note

- Press **OPTION** to cancel setup before it is completed.
- A CD can be inserted into the disc slot even when the child lock function is enabled. Take all necessary precautions to prevent children from inserting other objects into the disc slot.

Charging a mobile device (Qi)

A mobile device with the Qi icon can be charged with this unit. For more information regarding the Qi charging function, see documentation provided with your mobile device.

Note

The Qi charging function is not available in any of the following situations:

- The unit is in eco standby mode.
- The Qi function is disabled.
- Charge in Standby setting is disabled (☞ p. 33) and the unit is in standby mode.

Place the mobile device with its Qi icon facing down on the unit's Qi icon.

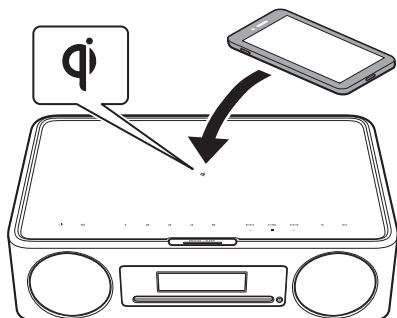

Do not place metallic objects, such as straps with metal components, near the Qi icon. Failure to observe this precaution may result in a fire, burn, or other injury.

Charging status can be confirmed using the Qi charging indicator.

	Charging possible
	Charging in progress
	Charging complete The indicator may not change to the charging complete indicator with some devices, even when they are fully charged.
	Charging failed Be sure that no other objects are positioned near the Qi icon. If you have confirmed that nothing is interfering with Qi function, see "Troubleshooting" for more information (☞ p. 37).

Note

- If charging does not begin, remove the device and place it on the Qi icon again.
- Remove any cover or case attached to the mobile device while charging. If a magnetic card or smart card is positioned between the unit and the mobile device during charging, the magnetic stripe or radio-frequency identification (RFID) chip used on some credit cards or passports may be damaged.
- Charging may take longer at high ambient temperatures.
- If vibrations generated by audio output cause the mobile device to move, position the non-skid pad (supplied) with the rough surface upward between the mobile device and the unit.

Adjusting display brightness (dimmer)

Display brightness can be adjusted automatically or manually.

<p>Auto The unit automatically selects brightness for bright and dark levels in accordance with ambient lighting. Brightness for both levels can be fine-tuned. Higher values are brighter.</p>	<p>Bright level options 5 to 9 (default: 7)</p> <p>Dark level options 0 to 4 (default: 2)</p>
<p>Manual Select the preferred brightness level from 10 options.</p>	<p>0 to 9 (default: 7)</p>



- 1 Press **OPTION**.
- 2 Use ◀/▶ to select  and then press **ENTER**.
- 3 Use ▲/▼ to select **Dimmer** and then press **ENTER**.
- 4 Use ▲/▼ to select **Auto** or **Manual**.

- 5 Use ▶ to move to the parameter setting, and use ▲/▼ to specify the level.

The following display is shown when **Auto** is selected.
(**B-Lv**: Bright level, **D-Lv**: Dark level)



- 6 Press **ENTER** to complete setup.
- 7 Press **OPTION** to exit the settings display.

Option settings

Various settings can be configured using the option menu. See “Option menu list” on the next page for available options.



- 1 Press **OPTION**.









- 2 Use **◀/▶** to select a menu group and then press **ENTER**.

- 3 Use **▲/▼/◀/▶** to select a setting and then press **ENTER**.

Press **OPTION** to cancel setup before it is completed.

- 4 Press **OPTION** to exit the settings display.

Option menu list

Group	Setting		
OPTION  CLOCK	Clock Setting (☞ p. 10)		
	Alarm Setting (☞ p. 26)		
OPTION  AUDIO	EQ Setting (☞ p. 24)		
	Sound Mode (☞ p. 24)		
OPTION  BLUETOOTH	Bluetooth TX (☞ p. 13)		
	Dimmer (☞ p. 31)		
	Menu Language	Select a display language.	
	Qi Function (☞ p. 30)		
		Auto Power Standby (☞ p. 9)	
	OPTION  SYSTEM	Standby Setting	ECO Standby Minimize power consumption (☞ p. 9)
			Charge When this function is disabled, the Qi/USB charging function is not available (default: Enable) (☞ p. 30).
	Child Lock (☞ p. 29)		
	Disc Manual Eject	Eject the CD.	
	Initial Setting	Restore the unit to factory default settings (changes to option settings will also be reset).	
Firmware	Version Information	Display the unit's firmware version.	
	Firmware Update	Update the unit's firmware. The latest firmware can be downloaded from the Yamaha website. See information provided when updating firmware for details.	
OPTION 1)  FM	Auto Preset (☞ p. 18)		
	Preset Delete (☞ p. 19)		
OPTION 2)  DAB	Initial Scan (☞ p. 15)		
	Tuning Aid (☞ p. 17)		
	Preset Delete (☞ p. 16)		







¹⁾ Displayed only when the input source is FM

²⁾ Displayed only when the input source is DAB

Troubleshooting

Refer to the table below if the unit fails to function properly. If the problem is not listed, or if the symptoms persist after following the instructions provided, turn off the unit, disconnect the unit from the electrical outlet, and contact your nearest authorized Yamaha dealer or service center.

General

Problem	Cause	Solution
The unit turns off as soon as it is powered on. The unit does not operate properly.	The power cable is not properly connected.	Connect the power cable firmly.
The unit cannot be operated.	The internal microcomputer has frozen due to an external electrical shock (lightning, excessive static electricity, etc.) or a drop in power supply voltage.	Press and hold  on the unit for at least eight seconds. The unit will be in standby mode.
No sound comes from the unit.	An input source has not been properly selected.	Use the input source buttons to select an input source ( p. 7).
	The volume level is set to the minimum level or volume is muted.	Increase the volume.
	The TX (transmitting) mode is applied to the Bluetooth function.	Apply the RX (receiving) mode to the Bluetooth function ( p. 12).
	The external device is not firmly connected to the AUX jack.	Confirm that the external device is firmly connected to the unit's jack. If there are no problems with connection, check that cables may be damaged.
Noise is heard.	The audio cable used to connect the unit and external device may be damaged.	Confirm the audio cable connection. If there are no problems with connection, use another audio cable.
The unit suddenly turns off.	The sleep timer has been set ( p. 10). The auto power standby function is activated. ( p. 9).	Turn on the unit and play the source again.
Breaks, distortion, or unusual noise can be heard.	The volume (especially the bass) is too high.	Decrease the volume, or adjust the bass ( p. 24).

Problem	Cause	Solution
The unit's clock is reset.	Power has not been supplied to the unit for more than one week.	If the power cord has been disconnected from the electrical outlet for more than one week, the clock may be reset. Set the clock again (☞ p. 10).
Interference from nearby electronic equipment is producing noise.	The unit is too close to other electronic equipment.	Position the unit farther away from other electronic equipment.
The remote control does not work or does not function properly.	The remote control may be outside its operation range.	Operate the remote control within its operation range (☞ p. 9).
	The remote control sensor on this unit may be exposed to direct sunlight or strong lighting such as an inverter type fluorescent lamp.	Change the orientation of lighting or the unit, or location of the unit.
	The battery may be worn out.	Replace the battery (CR2025) with a new one (☞ p. 8).
The touch sensors on the unit cannot be operated.	There are obstacles between the sensor of this unit and the remote control.	Remove the obstacles.
	The child lock function is enabled.	Disable the child lock function (☞ p. 29).
	Objects have been placed on the touch sensors.	Do not place objects on the touch sensors.

Bluetooth

Problem	Cause	Solution
Unable to connect the unit to a Bluetooth device.	The unit is already connected to another Bluetooth device.	Terminate the current Bluetooth connection, and then connect to the new device.
	The unit and the Bluetooth device are too far apart.	Move the Bluetooth device closer to the unit.
	A device that operates in the 2.4 GHz-band (microwave oven, wireless network device, etc.) is interfering with wireless communication.	Move the unit and Bluetooth device farther away from the device. If the wireless LAN router supports the 5 GHz-band, connect network devices to the network using the 5 GHz-band.
	The passkey for devices such as a Bluetooth adapter is not "0000".	Use a Bluetooth device with a passkey of "0000."
	The Bluetooth device does not support the Advanced Audio Distribution Profile (A2DP).	Use a Bluetooth device that supports A2DP.
No sound is played, or sound is interrupted during playback.	The volume level on the Bluetooth device is set too low.	Increase the volume on the Bluetooth device.
	The Bluetooth device is not configured to transmit audio signal to this unit.	On the Bluetooth device, select this unit as the audio output destination.
	The Bluetooth connection has been terminated.	Establish the Bluetooth connection again (☞ p. 12).
	A device that operates in the 2.4 GHz band (microwave oven, wireless network device, etc.) is interfering with wireless communication.	Move the unit and Bluetooth device farther away from the device. If the wireless LAN router supports the 5 GHz band, connect network devices to the network using the 5 GHz band.
	The unit and the Bluetooth device are too far apart.	Move the Bluetooth device closer to the unit.

Disc

Problem	Cause	Solution
Playback does not start after a disc is inserted. Some functions are not available.	The unit does not support the disc inserted.	Use a disc that is supported by the unit (☞ p. 41).
Playback does not start (or stops immediately) when ▷/⏏ is pressed.	The disc may be dirty.	Wipe the disc clean (☞ p. 41).
	The unit does not support the disc inserted.	Use a disc that is supported by the unit (☞ p. 41).
	If the unit was moved from a cold to warm place, condensation may have formed on the disc reading lens.	Wait for an hour or two until the unit adjusts to the room temperature, and try again.
The CD is not ejected when ▲ is pressed.	_____	Use Disc Manual Eject in the option settings to eject the disc (☞ p. 33).

Qi

Problem	Cause	Solution
The unit stops charging.	Objects are positioned near the Qi icon.	Remove the objects.
	The unit will temporarily stop charging when it or the mobile device becomes too hot.	Charging will resume once the temperature of the unit or mobile device has dropped to an acceptable temperature.

USB flash drive

Problem	Cause	Solution
The unit does not detect the USB flash drive.	The USB flash drive is not connected to the USB jack securely.	Turn off the unit, reconnect your USB flash drive, and turn the unit on again (☞ p. 20).
	A USB flash drive in a format other than FAT16/32 format is used.	Use a USB flash drive with FAT16 or FAT32 format.
Folders and files in the USB flash drive cannot be viewed.	The data in the USB flash drive is protected by encryption.	Use a USB flash drive without an encryption function.
Playback does not begin, or playback stops at the beginning.	The music file is not supported by the unit.	Confirm the file formats that are supported by the unit (☞ p. 42).

DAB reception (Australia model only)

Problem	Cause	Solution
Cannot tune in to any DAB stations.	The initial scan operations were not performed.	Perform the initial scan operations (☞ p. 15).
The initial scan operations are not successful and Not Found is displayed.	The DAB signals are too weak.	Use the Tuning Aid feature to conform the best position of the antenna (☞ p. 17).
	The positioning of the antenna is not optimal for DAB reception.	
	There is no DAB coverage in your area.	Check with your dealer or WorldDMB online at http://www.worlddab.org for a listing of the DAB coverage in your area.
There is noise interference (e.g. hiss, crackle or jitter).	The antenna needs to be repositioned.	Readjust the position of the antenna.
	The DAB signals are too weak.	Use the Tuning Aid feature to conform the best position of the antenna (☞ p. 17).
The DAB station information is not shown or is inaccurate.	The DAB station may be temporarily out of service, or the DAB station information is not provided by the DAB broadcaster.	Contact the DAB broadcaster.

FM reception

Problem	Cause	Solution
FM stereo reception is noisy.	The radio station you selected may be far from your area, or the antenna input is poor.	Change the height or direction of the antenna, or change the position of the unit.
Automatic tuning does not work.	The radio station you selected may be far from your area, or the antenna input is poor.	Change the height or direction of the antenna, or change the position of the unit. Tune in to a station manually (☞ p. 18).
Cannot select a preset radio station.	The preset stations may have been erased.	Preset radio stations again (☞ p. 18).
There is distortion, and clear reception cannot be obtained.	Multipath reflection or other radio interference may be occurring. Qi charging is interfering with radio reception.	Change the height or direction of the antenna, or change the position of the unit. Disable the Qi charging function (☞ p. 33).

Messages in the display

Message	Description	Solution
No Disc	The disc inserted in the unit may not be supported.	Use the disc supported by the unit (☞ p. 41).
	The disc may be dirty, or foreign matter may be attached to it.	Wipe the disc clean. Alternatively, remove foreign matter adhered to the disc.
Reading	The unit is reading the specified file/content.	Wait until the unit finishes reading.
Unknown Disc	Disc is set upside-down.	Set the disc with the labeled side facing up.
	A disc that is not recognized by the unit has been inserted.	Confirm that the disc is supported by the unit (☞ p. 41).
Unknown Media	A disc or USB flash drive that is not recognized by the unit has been inserted or connected.	Confirm that the disc or USB flash drive is supported by the unit (☞ p. 41).
Invalid Disc		
No Files	A disc or USB flash drive does not contain files supported by the unit.	Use the disc or USB flash drive that contains files supported by the unit (☞ p. 41).
Read Error	The unit failed to read the specified file/content.	Eject the disc or disconnect the USB flash drive, and then insert the disc or connect the USB flash drive again.
Not Connected	The Bluetooth connection is not established.	Confirm the Bluetooth connection.

Devices/media, and file formats supported by the unit

Devices/media

USB flash drives

- This unit is compatible with USB flash drives that are in FAT16 or FAT32 format. Do not connect any other type of USB flash drives.
- USB flash drives with encryption cannot be used.
- Operation of all USB flash drives cannot be guaranteed.

Yamaha and suppliers do not accept any liability for the loss of data saved on a USB flash drive connected to the unit. As a precaution, it is recommended to make backup copies of important files.

Discs

- This unit is designed for use with audio CD, CD-R/RW (ISO 9660 format) with any of the following logos printed on the disc or the disc jacket.

Audio CD



CD-R/RW*



* Discs which bear one of the following.
FOR CONSUMER
FOR CONSUMER USE
FOR MUSIC USE ONLY

Notes on discs

- Do not use any other type of disc other than stated above. Doing so may damage the unit.
- CD-R/RW cannot be played back unless finalized. Finalization means the process for making a disc to be ready for playback on a compatible device.
- Some discs cannot be played back depending on the disc characteristics or recording conditions.

- Do not use any non-standard shaped discs such as a heart-shaped disc.
- Do not use discs with many scratches or a crack on their surface, or warped/glued discs.
- Do not touch the surface of the disc. Hold a disc by its edge or center hole.
- Use a soft-tipped pen when writing on the label side of a disc.
- Do not use a disc to which tape, stickers, or labels have been affixed. Discs with any of these inserted into the unit may not be ejected.
- Do not use a protective cover to prevent scratches.
- Do not insert any object other than a disc into the unit.
- Do not insert more than one disc into the unit at one time. This could cause damage to both this unit and the discs.
- If a disc becomes dirty, wipe it with a clean, dry soft cloth from the center out to the edge. Do not use record cleaner or paint thinner.
- Do not use any lens cleaners as they may cause malfunction.
- Do not expose discs to direct sunlight, high temperature, high humidity, or dust.
- When a disc is not being used, remove it from this unit and store in an appropriate case.

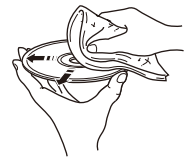

File format

USB

Format	Sampling frequency (kHz)	Quantization bits (bit)	Bitrate (kbps)	Number of channels
WAV*	32/44.1/48/88.2/ 96/176.4/192	16/24	-	2
MP3	32/44.1/48	-	8-320	2
WMA	32/44.1/48	-	8-320	2
MPEG-4 AAC-LC	32/44.1/48	-	8-320	2
FLAC	32/44.1/48/88.2/ 96/176.4/192**	16/24	-	2
ALAC	32/44.1/48	16/24	-	2
AIFF	32/44.1/48/88.2/ 96/176.4/192	16/24	-	2

* Linear PCM format only

** Some music files and content utilizing certain compression ratios may not play properly.

Digital Rights Management (DRM) files cannot be played back.

CD

Format	Sampling frequency (kHz)	Quantization bits (bit)	Bitrate (kbps)	Number of channels
MP3	32/44.1/48	16	8-320	2
WMA	32/44.1/48	16	8-320	2

Specifications

Input

AUX	3.5 mm stereo mini jack
-----	-------------------------

Output

HEADPHONES	3.5 mm stereo mini jack
------------	-------------------------

USB

Audio format	MP3, WMA, AAC, WAV, FLAC, ALAC, AIFF
--------------	--------------------------------------

CD

Laser	Type	Semiconductor laser GaAs/GaAlAs
	Wave length	775 to 780 nm
	Output power	4 mW
Media*	CD, CD-R/RW	
Audio format	Audio CD, MP3, WMA	

* An 8-cm mini CD is not available.

Bluetooth

Bluetooth version	Ver. 4.2
Supported profile	A2DP (sink and source functions) AVRCP
Compatible codecs	SBC
Maximum communication range	10 m (33 ft) (without interference)
Bluetooth output	Class 1

Tuner

Tuning range	FM	Canada model: 87.5 MHz to 107.9 MHz Other models: 87.5 MHz to 108.0 MHz
--------------	----	--

DAB (Australia model only)

Tuning range	DAB	174 MHz to 240 MHz (Band III)
--------------	-----	-------------------------------

Amplifier section

Maximum output power	Speakers	25 W + 25 W (6 Ω, 1 kHz, 10 % THD)
	Headphones	20 mW + 20 mW (16 to 32 Ω, 1 kHz, 10 % THD)

Wireless Charge

Standard	Qi certified
----------	--------------

General

Power supply	Voltage/ frequency	Canada model: AC 120 V, 60 Hz Australia model: AC 220 to 240 V, 50 Hz Asia model: AC 100 to 240 V, 50/60 Hz Taiwan model: AC 110 to 120 V, 50/60 Hz China model: AC 220 V, 50 Hz Korea model: AC 220 V, 60 Hz
Power consumption		42 W
Standby power consumption		Eco Standby (enabled): 0.9 W or less (Option settings: Dimmer level 7) Eco Standby (disabled): 1.8 W or less (Option settings: Dimmer level 7, Charge disabled)
Dimensions (W × H × D)		370 × 111 × 252 mm (14-5/8 × 4-3/8 × 9-7/8 inch)
Weight		4.2 kg (9.3 lbs.)

The contents of this manual apply to the latest specifications as of the publishing date. To obtain the latest manual, access the Yamaha website then download the manual file.



Yamaha Eco-Label is a mark that certifies products of high environmental performance.



The Bluetooth® word mark and logos are registered trademarks owned by Bluetooth SIG, Inc. and any use of such marks by Yamaha Corporation is under license. Other trademarks and trade names are those of their respective owners.



The 'Qi' symbol is a trademark of the Wireless Power Consortium.



Australia model only

Software licenses

This product uses the following software.

Apache License

Version 2.0, January 2004
<http://www.apache.org/licenses/>

TERMS AND CONDITIONS FOR USE, REPRODUCTION, AND DISTRIBUTION

1. Definitions.

"License" shall mean the terms and conditions for use, reproduction, and distribution as defined by Sections 1 through 9 of this document.

"Licensor" shall mean the copyright owner or entity authorized by the copyright owner that is granting the License.

"Legal Entity" shall mean the union of the acting entity and all other entities that control, are controlled by, or are under common control with that entity. For the purposes of this definition, "control" means (i) the power, direct or indirect, to cause the direction or management of such entity, whether by contract or otherwise, or (ii) ownership of fifty percent (50%) or more of the outstanding shares, or (iii) beneficial ownership of such entity.

"You" (or "Your") shall mean an individual or Legal Entity exercising permissions granted by this License.

"Source" form shall mean the preferred form for making modifications, including but not limited to software source code, documentation source, and configuration files.

"Object" form shall mean any form resulting from mechanical transformation or translation of a Source form, including but not limited to compiled object code, generated documentation, and conversions to other media types.

"Work" shall mean the work of authorship, whether in Source or Object form, made available under the License, as indicated by a copyright notice that is included in or attached to the work (an example is provided in the Appendix below).

"Derivative Works" shall mean any work, whether in Source or Object form, that is based on (or derived from) the Work and for which the editorial revisions, annotations, elaborations, or other modifications represent, as a whole, an original work of authorship. For the purposes of this License, Derivative Works shall not include works that remain separable from, or merely link (or bind by name) to the interfaces of, the Work and Derivative Works thereof.

"Contribution" shall mean any work of authorship, including the original version of the Work and any modifications or additions to that Work or Derivative Works thereof, that is intentionally submitted to Licensor for inclusion in the Work by the copyright owner or by an individual or Legal Entity authorized to submit on behalf of the copyright owner. For the purposes of this definition, "submitted" means any form of electronic, verbal, or written communication sent to the Licensor or its representatives, including but not limited to communication on electronic mailing lists, source code control systems, and issue tracking systems that are managed by, or on behalf of, the Licensor for the purpose of discussing and improving the Work, but excluding communication that is conspicuously marked or otherwise designated in writing by the copyright owner as "Not a Contribution."

"Contributor" shall mean Licensor and any individual or Legal Entity on behalf of whom a Contribution has been received by Licensor and subsequently incorporated within the Work.

2. Grant of Copyright License. Subject to the terms and conditions of this License, each Contributor hereby grants to You a perpetual, worldwide, non-exclusive, no-charge, royalty-free, irrevocable copyright license to reproduce, prepare Derivative Works of, publicly display, publicly perform, sublicense, and distribute the Work and such Derivative Works in Source or Object form.

3. Grant of Patent License. Subject to the terms and conditions of this License, each Contributor hereby grants to You a perpetual, worldwide, non-exclusive, no-charge, royalty-free, irrevocable

(except as stated in this section) patent license to make, have made, use, offer to sell, sell, import, and otherwise transfer the Work, where such license applies only to those patent claims licensable by such Contributor that are necessarily infringed by their Contribution(s) alone or by combination of their Contribution(s) with the Work to which such Contribution(s) was submitted. If You institute patent litigation against any entity (including a cross-claim or counterclaim in a lawsuit) alleging that the Work or a Contribution incorporated within the Work constitutes direct or contributory patent infringement, then any patent licenses granted to You under this License for that Work shall terminate as of the date such litigation is filed.

4. Redistribution. You may reproduce and distribute copies of the Work or Derivative Works thereof in any medium, with or without modifications, and in Source or Object form, provided that You meet the following conditions:

(a) You must give any other recipients of the Work or Derivative Works a copy of this License; and
(b) You must cause any modified files to carry prominent notices stating that You changed the files; and

(c) You must retain, in the Source form of any Derivative Works that You distribute, all copyright, patent, trademark, and attribution notices from the Source form of the Work, excluding those notices that do not pertain to any part of the Derivative Works; and

(d) If the Work includes a "NOTICE" text file as part of its distribution, then any Derivative Works that You distribute must include a readable copy of the attribution notices contained within such NOTICE file, excluding those notices that do not pertain to any part of the Derivative Works, in at least one of the following places: within a NOTICE text file distributed as part of the Derivative Works; within the Source form or documentation, if provided along with the Derivative Works; or, within a display generated by the Derivative Works, if and wherever such third-party notices normally appear. The contents of the NOTICE file are for informational purposes only and do not modify the License. You may add Your own attribution notices within Derivative Works that You distribute, alongside or as an addendum to the NOTICE text from the Work, provided that such additional attribution notices cannot be construed as modifying the License.

You may add Your own copyright statement to Your modifications and may provide additional or different license terms and conditions for use, reproduction, or distribution of Your modifications, or for any such Derivative Works as a whole, provided Your use, reproduction, and distribution of the Work otherwise complies with the conditions stated in this License.

5. Submission of Contributions. Unless You explicitly state otherwise, any Contribution intentionally submitted for inclusion in the Work by You to the Licensor shall be under the terms and conditions of this License, without any additional terms or conditions. Notwithstanding the above, nothing herein shall supersede or modify the terms of any separate license agreement you may have executed with Licensor regarding such Contributions.

6. Trademarks. This License does not grant permission to use the trade names, trademarks, service marks, or product names of the Licensor, except as required for reasonable and customary use in describing the origin of the Work and reproducing the content of the NOTICE file.

7. Disclaimer of Warranty. Unless required by applicable law or agreed to in writing, Licensor provides the Work (and each Contributor provides its Contributions) on an "AS IS" BASIS, WITHOUT WARRANTIES OR CONDITIONS OF ANY KIND, either express or implied, including, without limitation, any warranties or conditions of TITLE, NON-INFRINGEMENT, MERCHANTABILITY, or FITNESS FOR A PARTICULAR PURPOSE. You are solely responsible for determining the appropriateness of using or redistributing the Work and assume any risks associated with Your exercise of permissions under this License.

8. Limitation of Liability. In no event and under no legal theory, whether in tort (including negligence), contract, or otherwise, unless required by applicable law (such as deliberate and grossly negligent acts) or agreed to in writing, shall any Contributor be liable to You for damages, including any direct, indirect, special, incidental, or consequential damages of any character arising as a result of this License or out of the use or inability to use the Work (including but not limited to damages for loss of goodwill, work stoppage, computer failure or malfunction, or any and all other commercial damages or losses), even if such Contributor has been advised of the possibility of such damages.

9. Accepting Warranty or Additional Liability. While redistributing the Work or Derivative Works thereof, You may choose to offer, and charge a fee for, acceptance of support, warranty, indemnity, or other liability obligations and/or rights consistent with this License. However, in accepting such obligations, You may act only on Your own behalf and on Your sole responsibility, not on behalf of any other Contributor, and only if You agree to indemnify, defend, and hold each Contributor harmless for any liability incurred by, or claims asserted against, such Contributor by reason of your accepting any such warranty or additional liability.

END OF TERMS AND CONDITIONS

FLAC

Copyright © 2000–2009 Josh Coalson
Copyright © 2011–2016 Xiph.Org Foundation

Redistribution and use in source and binary forms, with or without modification, are permitted provided that the following conditions are met:

- Redistributions of source code must retain the above copyright notice, this list of conditions and the following disclaimer.
- Redistributions in binary form must reproduce the above copyright notice, this list of conditions and the following disclaimer in the documentation and/or other materials provided with the distribution.
- Neither the name of the Xiph.org Foundation nor the names of its contributors may be used to endorse or promote products derived from this software without specific prior written permission.

THIS SOFTWARE IS PROVIDED BY THE COPYRIGHT HOLDERS AND CONTRIBUTORS "AS IS" AND ANY EXPRESS OR IMPLIED WARRANTIES, INCLUDING, BUT NOT LIMITED TO, THE IMPLIED WARRANTIES OF MERCHANTABILITY AND FITNESS FOR A PARTICULAR PURPOSE ARE DISCLAIMED. IN NO EVENT SHALL THE FOUNDATION OR CONTRIBUTORS BE LIABLE FOR ANY DIRECT, INDIRECT, INCIDENTAL, SPECIAL, EXEMPLARY, OR CONSEQUENTIAL DAMAGES (INCLUDING, BUT NOT LIMITED TO, PROCUREMENT OF SUBSTITUTE GOODS OR SERVICES; LOSS OF USE, DATA, OR PROFITS; OR BUSINESS INTERRUPTION) HOWEVER CAUSED AND ON ANY THEORY OF LIABILITY, WHETHER IN CONTRACT, STRICT LIABILITY, OR TORT (INCLUDING NEGLIGENCE OR OTHERWISE) ARISING IN ANY WAY OUT OF THE USE OF THIS SOFTWARE, EVEN IF ADVISED OF THE POSSIBILITY OF SUCH DAMAGE.

YAMAHA CORPORATION

10-1 Nakazawa-cho, Naka-ku, Hamamatsu, 430-8650 Japan

Yamaha Global Site
<https://www.yamaha.com/>

Yamaha Downloads
<https://download.yamaha.com/>

Manual Development Group
© 2020 Yamaha Corporation
Published 07/2021
KSEM-B0

AV18-0100