

**YAMAHA**  
*Clavinova PF*  
**P-100**

**OWNER'S MANUAL**



## FCC INFORMATION (U.S.A.)

### 1. IMPORTANT NOTICE: DO NOT MODIFY THIS UNIT!

This product, when installed as indicated in the instructions contained in this manual, meets FCC requirements. Modifications not expressly approved by Yamaha may void your authority, granted by the FCC, to use the product.

### 2. IMPORTANT: When connecting this product to accessories and/or another product use only high quality shielded cables. Cable/s supplied with this product MUST be used. Follow all installation instructions. Failure to follow instructions could void your FCC authorization to use this product in the USA.

### 3. NOTE: This product has been tested and found to comply with the requirements listed in FCC Regulations, Part 15 for Class "B" digital devices. Compliance with these requirements provides a reasonable level of assurance that your use of this product in a residential environment will not result in harmful interference with other electronic devices. This equipment generates/uses radio frequencies and, if not installed and used according to the instructions found in the users manual, may cause interference harmful to the operation of other electronic devices. Compliance with FCC regulations does not guarantee that interference will not occur in all installations. If this product is found to be the source of interference, which can be determined by turning the unit "OFF" and "ON", please try to eliminate the problem by using one of the following measures:

Relocate either this product or the device that is being affected by the interference.

Utilize power outlets that are on different branch (circuit breaker or fuse) circuits or install AC line filter/s.

In the case of radio or TV interference, relocate/reorient the antenna. If the antenna lead-in is 300 ohm ribbon lead, change the lead-in to co-axial type

If these corrective measures do not produce satisfactory results, please contact the local retailer authorized to distribute this type of product. If you can not locate the appropriate retailer, please contact Yamaha Corporation of America, Electronic Service Division, 6600 Orangethorpe Ave, Buena Park, CA 90620

\* This applies only to products distributed by YAMAHA CORPORATION OF AMERICA.

Dette apparat overholder det gaeldende EF-direktiv vedrørende radiostørj.

Cet appareil est conforme aux prescriptions de la directive communautaire 87/308/CEE.

Diese Geräte entsprechen der EG-Richtlinie 82/499/EWG und/oder 87/308/EWG.

This product complies with the radio frequency interference requirements of the Council Directive 82/499/EEC and/or 87/308/EEC.

Questo apparecchio è conforme al D.M.13 aprile 1989 (Direttiva CEE/87/308) sulla soppressione dei radio-disturbi.

Este producto está de acuerdo con los requisitos sobre interferencias de radio frecuencia fijados por el Consejo Directivo 87/308/CEE.

**YAMAHA CORPORATION**

## CANADA

THIS DIGITAL APPARATUS DOES NOT EXCEED THE "CLASS B" LIMITS FOR RADIO NOISE EMISSIONS FROM DIGITAL APPARATUS SET OUT IN THE RADIO INTERFERENCE REGULATION OF THE CANADIAN DEPARTMENT OF COMMUNICATIONS.

LE PRESENT APPAREIL NUMERIQUE N'EMET PAS DE BRUITS RADIOELECTRIQUES DEPASSANT LES LIMITES APPLICABLES AUX APPAREILS NUMERIQUES DE LA "CLASSE B" PRESCRITES DANS LE REGLEMENT SUR LE BROUILLAGE RADIOELECTRIQUE EDICTE PAR LE MINISTERE DES COMMUNICATIONS DU CANADA.

\* This applies only to products distributed by YAMAHA CANADA MUSIC LTD.

Litiumbatteri!  
Bör endast bytas av servicepersonal.  
Explosionsfara vid felaktig hantering.

VAROITUS!  
Lithiumparisto, Räjähdyksvaara.  
Pariston saa vaihtaa ainoastaan alan ammattimies.

ADVARSEL!  
Lithiumbatteri!  
Eksplosionsfare. Udskiftning må kun foretages af en sagkyndig, – og som beskrevet i servicemanualen.

## IMPORTANT NOTICE FOR THE UNITED KINGDOM

Connecting the Plug and Cord

**IMPORTANT**  
**THE WIRES IN MAINS LEAD ARE COLOURED IN ACCORDANCE WITH THE FOLLOWING CODE:**

Blue: NEUTRAL  
Brown: LIVE

As the colours of the wires in the mains lead of this apparatus may not correspond with the coloured markings identifying the terminals in your plug, proceed as follows: The wire which is coloured BLUE must be connected to the terminal which is marked with the letter N or coloured BLACK. The wire which is coloured BROWN must be connected to the terminal which is marked with the letter L or coloured RED.

Making sure that neither core is connected to the earth terminal of the three pin plug.

# SPECIAL MESSAGE SECTION

**PRODUCT SAFETY MARKINGS:** Yamaha electronic products may have either labels similar to the graphics shown below or molded/stamped facsimiles of these graphics on the enclosure. The explanation of these graphics appears on this page. Please observe all cautions indicated on this page and those indicated in the safety instruction section.

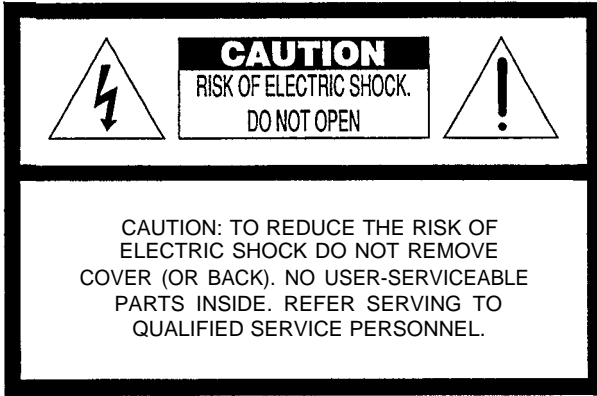

The exclamation point within the equilateral triangle is intended to alert the user to the presence of important operating and maintenance (servicing) instructions in the literature accompanying the product.

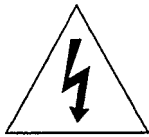

The lightning flash with arrowhead symbol within the equilateral triangle is intended to alert the user to the presence of uninsulated “dangerous voltage” within the product’s enclosure that may be of sufficient magnitude to constitute a risk of electrical shock.

**IMPORTANT NOTICE:** All Yamaha electronic products are tested and approved by an independent safety testing laboratory in order that you may be sure that when it is properly installed and used in its normal and customary manner all foreseeable risks have been eliminated. **DO NOT** modify this unit or commission others to do so unless specifically authorized by Yamaha. Product performance and/or safety standards may be diminished. Claims filed under the expressed warranty may be denied if the unit is/has been modified. Implied warranties may also be affected.

**SPECIFICATIONS SUBJECT TO CHANGE:** The information contained in this manual is believed to be correct at the time of printing. However, Yamaha reserves the right to change or modify any of the specifications without notice or obligation to update existing units.

**ENVIRONMENTAL ISSUES:** Yamaha strives to produce products that are both user safe and environmentally friendly. We sincerely believe that our products and the production methods used to produce them, meet these goals. In keeping with both the letter and the spirit of the law we want you to be aware of the following:

**Battery Notice:** This product MAY contain a small non-rechargeable battery which (if applicable) is soldered in place. The average life span of this type of battery is approximately five years. When replacement becomes necessary, contact a qualified service representative to perform the replacement.

**Warning:** Do not attempt to recharge, disassemble, or incinerate this type of battery. Keep all batteries away from children. Dispose of used batteries promptly and as regulated by applicable laws. Note: In some areas, the servicer is required by law to return the defective parts. However, you do have the option of having the servicer dispose of these parts for you.

**Disposal Notice:** Should this product become damaged beyond repair or for some reason its useful life is considered to be at an end please observe all local, state, and federal regulations that relate to the disposal of products that contain lead, batteries, plastics, etc.

**NOTICE:** Service charges incurred due to lack of knowledge relating to how a function or effect works (when the unit is operating as designed), are not covered by the manufacturer’s warranty, and are therefore the owners responsibility. Please study this manual carefully and consult your dealer before requesting service.

**NAME PLATE LOCATION:** The graphic below indicates the location of the name plate. The model number, serial number, power requirements, etc., are located on this plate. You should record the model number, serial number, and the date of purchase in the spaces provided below and retain this manual as a permanent record of your purchase.

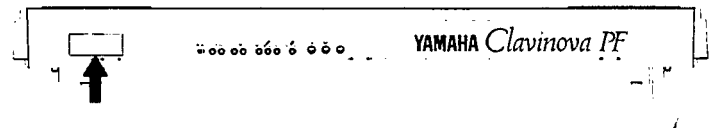

Model .....

Serial No. ....

Purchase Date .....

# IMPORTANT SAFETY AND INSTALLATION INSTRUCTIONS

---

INFORMATION RELATING TO POSSIBLE PERSONAL INJURY, ELECTRIC SHOCK, AND FIRE HAZARD POSSIBILITIES HAS BEEN INCLUDED IN THIS LIST.

**WARNING** — When using any electrical or electronic product, basic precautions should always be followed. These precautions include, but are not limited to, the following:

1. Read all Safety Instructions, Installation Instructions, Special Message Section items, and any Assembly Instructions found in this manual **BEFORE** making any connections, including connection to the main supply.
2. Main Power Supply Verification: Yamaha products are manufactured specifically for the supply voltage in the area where they are to be sold. If you should move, or if any doubt exists about the supply voltage in your area, please contact your dealer for supply voltage verification and (if applicable) instructions. The required supply voltage is printed on the name plate. For name plate location, please refer to the graphic found in the Special Message Section of this manual.
3. This product may be equipped with a polarized plug (one blade wider than the other). If you are unable to insert the plug into the outlet, turn the plug over and try again. If the problem persists, contact an electrician to have the obsolete outlet replaced. Do **NOT** defeat the safety purpose of the plug.
4. Some electronic products utilize external power supplies or adapters. **DO NOT** connect this type of product to any power supply or adapter other than one described in the owners manual, on the name plate, or specifically recommended by Yamaha.
5. **WARNING:** Do not place this product or any other objects on the power cord or place it in a position where anyone could walk on, trip over, or roll anything over power or connecting cords of any kind. The Use of an extension cord is not recommended! If you must use an extension cord, the minimum wire size for a 25' cord (or less) is 18 AWG. **NOTE:** The smaller the AWG number, the larger the current handling capacity. For longer extension cords, consult a local electrician.
6. Ventilation: Electronic products, unless specifically designed for enclosed installations, should be placed in locations that do not interfere with proper ventilation. If instructions for enclosed installations are not provided, it must be assumed that unobstructed ventilation is required.
7. Temperature considerations: Electronic products should be installed in locations that do not significantly contribute to their operating temperature. Placement of this product close to heat sources such as: radiators, heat registers and other devices that product heat should be avoided.
8. This product was **NOT** designed for use in wet/damp locations and should not be used near water or exposed to rain. Examples of wet/damp locations are: near a swimming pool, spa, tub, sink, or wet basement.
9. This product should be used only with the components supplied or; a cart, rack, or stand that is recommended by the manufacturer. If a cart, rack, or stand is used, please observe all safety markings and instructions that accompany the accessory product.
10. The power supply cord (plug) should be disconnected from the outlet when electronic products are to be left unused for extended periods of time. Cords should also be disconnected when there is a high probability of lightning and/or electrical storm activity.
11. Care should be taken that objects do not fall and liquids are not spilled into the enclosure through any openings that may exist.
12. Electrical/electronic products should be serviced by a qualified service person when:
  - a. The power supply cord has been damaged; or
  - b. Objects have fallen, been inserted, or liquids have been spilled into the enclosure through openings; or
  - c. The product has been exposed to rain; or
  - d. The product does not operate, exhibits a marked change in performance; or
- c. The product has been dropped, or the enclosure of the product has been damaged.
13. Do not attempt to service this product beyond that described in the user-maintenance instructions. All other servicing should be referred to qualified service personnel.
14. This product, either alone or in combination with an amplifier and headphones or speaker/s, may be capable of producing sound levels that could cause permanent hearing loss. **DO NOT** operate for a long period of time at a high volume level or at a level that is uncomfortable. If you experience any hearing loss or ringing in the ears, you should consult an audiologist. **IMPORTANT:** The louder the sound, the shorter the time period before damage occurs.
15. Some Yamaha products may have benches and/or accessory mounting fixtures that are either supplied as a part of the product or as optional accessories. Some of these items are designed to be dealer assembled or installed. Please make sure that benches are stable and any optional fixtures (where applicable) are well secured **BEFORE** using Benches supplied by Yamaha are designed for seating only No other uses are recommended.

---

PLEASE KEEP THIS MANUAL

THANK YOU! ... for purchasing the Yamaha Clavinova PF Series P-100. The P-100 is a high-performance electronic piano with ten voices and a host of functions that make it an ideal instrument for professional stage and studio applications, as well as for use at home. Its features include the following:

---

- **High quality AWM sound**

The P-100 features a selection of ten voices and a maximum simultaneous note output of 32 polyphonic notes. All of the voices were recorded using the latest sampling techniques, then processed using Yamaha's patented AWM sound generation technology.

- **Superior piano sound**

Among the P-100's voices are two authentic piano sounds that are samples of actual acoustic instruments. One is a grand piano sound, with rich bass tones and sparkling high notes that capture the natural reverb characteristics of a real grand piano. The other is a bright contemporary piano that will make a perfect addition to any band.

- **Digital signal processing**

The P-100 has a built-in digital signal processor unit that provides full stereo reverb, chorus, symphonic, and tremolo effects, as well as an easy-to-control three-band equalizer that lets you tailor the P-100's sound to suit your taste.

- **Touch-sensitive keyboard**

The P-100's full-sized 88-note piano keyboard incorporates Yamaha's Action Effect keyboard technology, which gives it the feel and response of a real piano keyboard. You can even adjust the keyboard's sensitivity to suit your playing style, selecting from Normal, Soft, Hard, or Fixed settings.

- **Dual and Split voice modes**

The P-100 features Dual and Split voice modes that let you play combinations of two voices at once. In Split mode, the key transpose values can even be set independently for each voice. The P-100 thus gives you a wide range of performance flexibility in a single piano keyboard.

- **MIDI control capability**

The P-100 offers many of the control features found on a MIDI master keyboard: velocity sensitivity, pitch bend and modulation wheels, an assignable data slider, program change send and receive capabilities, and MIDI transpose and MIDI merge functions. Also, in addition to jacks for sustain, soft, and sostenuto pedals, the P-100 gives you the option of connecting a MIDI foot controller that can be assigned in the same manner as the continuous slider.

# CONTENTS

---

<b>PRECAUTIONS</b> .....	1	<b>MIDI UTILITY MODE SETTINGS</b> .....	31
<b>INTRODUCING THE P-100</b> .....	2	MIDI Utility mode .....	31
Upper panel .....	2	Transmit and receive channels .....	32
Rear panel .....	4	Local control .....	34
<b>SETTING UP THE P-100</b> .....	5	MIDI merge .....	35
<b>PLAYING THE DEMO SONGS</b> .....	6	Bulk protect .....	36
<b>PLAYING THE P-100</b> .....	7	Pitch bend range .....	37
Selecting a voice .....	7	Modulation wheel .....	38
Using the reverb effect .....	9	Assignable controllers .....	39
Using the modulation effects .....	10	Program change transmit table .....	40
Adjusting the equalization .....	11	Program change receive table .....	42
<b>DUAL MODE</b> .....	12	<b>SPECIAL OPERATIONS</b> .....	44
Selecting voices in Dual mode .....	12	Bulk dumps .....	44
Adjusting the voice balance .....	13	Memory initialization .....	45
Detuning the voices .....	14	<b>SYSTEM APPLICATIONS</b> .....	46
<b>SPLIT MODE</b> .....	15	Using the P-100 with a tone generator .....	46
Entering Split mode .....	15	Using the P-100 with another MIDI	
Selecting voices in Split mode .....	16	keyboard .....	47
Changing the split point .....	17	Using the P-100 in an extended MIDI	
<b>ADJUSTING THE KEYBOARD</b> .....	19	system .....	48
Tuning the P-100 .....	19	Using the P-100 with a MIDI data	
Selecting a velocity curve .....	20	recorder .....	49
Using the transpose function .....	21	<b>ERROR MESSAGES</b> .....	50
Setting the transpose amount .....	22	<b>SPECIFICATIONS</b> .....	51
Transposing in Dual and Split modes .....	23	<b>INDEX</b> .....	52
<b>MIDI KEYBOARD CONTROL</b>		<b>MIDI DATA FORMAT</b> .....	54
<b>FUNCTIONS</b> .....	25	<b>MIDI IMPLEMENTATION CHART</b> .....	58
What is MIDI? .....	25		
The P-100's MIDI configuration .....	27		
Enabling MIDI transmission .....	29		
Selecting a MIDI velocity curve .....	29		
Using the MIDI transpose function .....	30		

# Clavinova PF P-100 Operation Guide

## DEMO SONGS

DEMO PLAY MODE Page 6



SONG SELECTION Page 6

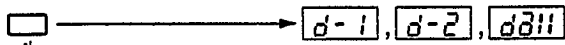

EXIT DEMO PLAY MODE Page 6



## VOICE MODES

SINGLE MODE Page 7

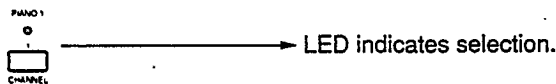

DUAL MODE Page 12

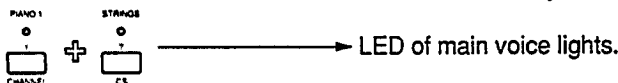

VOICE BALANCE Page 13

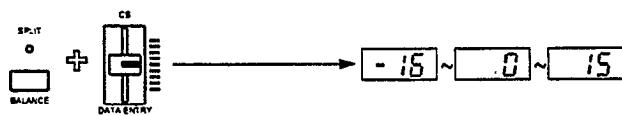

VOICE DETUNE Page 14

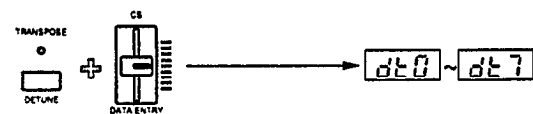

SPLIT MODE Page 15



VOICE BALANCE Page 16

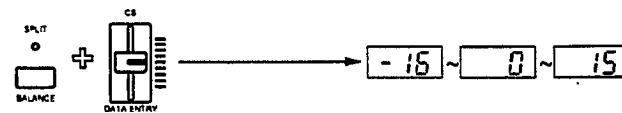

SUB VOICE Page 16

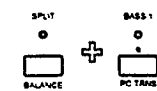

SPLIT POINT Page 17



MAIN KEYBOARD AREA Page 17

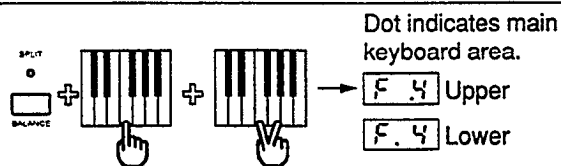

## KEYBOARD SETTINGS

MASTER TUNING Page 19



VELOCITY CURVE Page 20

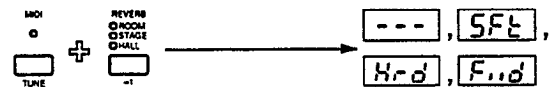

TRANSPOSE Page 21

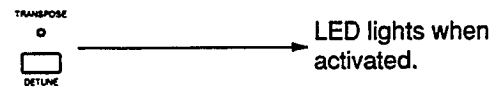

TRANSPOSE AMOUNT (main voice) Page 22

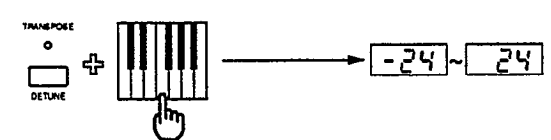

TRANSPOSE AMOUNT (sub voice) Page 23

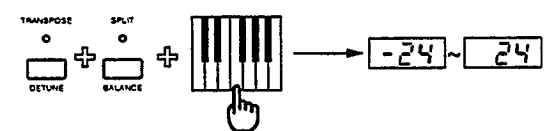

PIANO 1 MODE (STEREO/MONO) Page 8

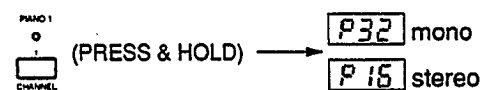

## EFFECT SETTINGS

REVERB TYPE Page 9

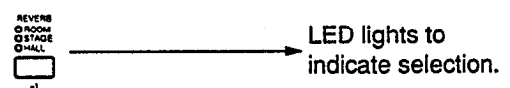

REVERB DEPTH Page 9

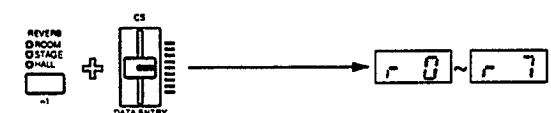

MODULATION EFFECT Page 10

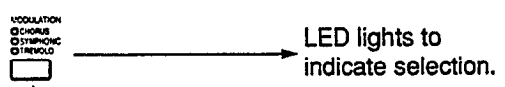

MODULATION EFFECT DEPTH Page 10

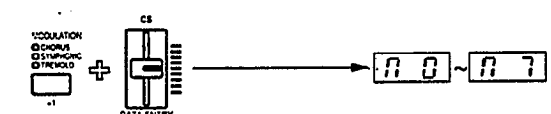

EQUALIZER Page 11

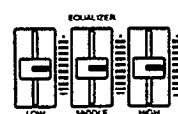

# Clavinova PF P-100 Operation Guide

## MIDI SETTINGS

<b>MIDI TRANSMISSION</b> Page 29	<b>TRANPOSE AMOUNT (Tch)</b> Page 30
MIDI TUNE → LED lights when enabled.	TRANPOSE + MIDI TUNE + Keyboard → -24 ~ 24
<b>MIDI VELOCITY CURVE</b> Page 29	<b>TRANPOSE AMOUNT (Tch+1)</b> Page 30
MIDI TUNE + MODULATION CHORUS SYMPHONIC TREMOLO → ---, SFT, Hrd, Fud	TRANPOSE + SPLIT + MIDI TUNE + Keyboard → -24 ~ 24
<b>MIDI TRANPOSE</b> Page 30	
TRANPOSE DETUNE → LED lights when activated.	

## MIDI UTILITY FUNCTIONS

<b>CHANNEL</b> Page 32	<b>FOOT CONTROLLER</b> Page 39
MIDI TUNE + PIANO 1 CHANNEL (TRANSMIT) → CS DATA ENTRY: t--, t1 ~ t15	MIDI TUNE + ORGAN FC → CS DATA ENTRY: ---, t t1, n n n, 5ub, 001 ~ 120, 8FT
MIDI CHANNEL (RECEIVE) → CS DATA ENTRY: r--, r1 ~ r15	<b>P.C. TRANSMIT TABLE</b> Page 40
MIDI CHANNEL (P.C. RECEIVE) → CS DATA ENTRY: P--, P1 ~ P15	MIDI TUNE + BASE 1 FC TRNS → CS DATA ENTRY: 1 ~ 128
<b>LOCAL CONTROL</b> Page 34	<b>P.C. RECEIVE TABLE</b> Page 42
MIDI TUNE + PIANO 2 LOCAL → CS DATA ENTRY: on, off	MIDI TUNE + BASE 2 PC RECV → CS DATA ENTRY: 1 ~ 128
<b>MIDI MERGE</b> Page 35	MIDI TUNE + PIANO 1 CHANNEL + BASE 2 PC RECV → CS DATA ENTRY: 1 ~ 128
MIDI TUNE + EPIANO 1 MERGE → CS DATA ENTRY: on, off	MIDI TUNE + PIANO 1 CHANNEL + BASE 2 PC RECV → Voice LED goes out.
<b>BULK PROTECT</b> Page 36	
MIDI TUNE + EPIANO 2 PROTECT → CS DATA ENTRY: on, bul, off	
<b>PITCH BEND RANGE</b> Page 37	
MIDI TUNE + CLAVINOVA TUNE PD → CS DATA ENTRY: 0 ~ 12	
<b>MODULATION WHEEL</b> Page 38	
MIDI TUNE + VIBES SW → CS DATA ENTRY: on, off	
<b>CONTINUOUS SLIDER</b> Page 39	
MIDI TUNE + STRINGS CS → CS DATA ENTRY: ---, H3n, 5ub, 001 ~ 120, 8FT	

## SPECIAL OPERATIONS

<b>MIDI BULK DUMP</b> Page 44
MIDI TUNE + EFFECT REVERSE MODULATION ROOM STAGE HALL CHORUS SYMPHONIC TREMOLO → bul All settings output as bulk dumps.
<b>MEMORY INITIALIZE</b> Page 45
MIDI TUNE + POWER ON/OFF → All settings reset to factory values.



**PLAYING THE DEMO SONGS**

---

**PLAYING THE P-100**

---

**DUAL MODE**

---

**SPLIT MODE**

---

**ADJUSTING THE KEYBOARD**

---

**MIDI KEYBOARD CONTROL FUNCTIONS**

---

**MIDI UTILITY MODE SETTINGS**

---

**SPECIAL OPERATIONS**

---

# PRECAUTIONS

---

The P-100 is a fine musical instrument composed of sensitive mechanisms and delicate digital circuitry. To ensure a long lifetime of reliable service, observe these precautions when installing, moving, or handling the P-100.

- **Location**

Do not use the P-100 in locations where it will be exposed to direct sunlight, extremes of temperature or humidity, or excessive dust or vibration.

- **Handling**

Avoid rough handling. Do not drop the P-100 or subject it to shock, as these can damage the piano's internal circuitry. Also, do not apply excessive force to controls or terminals. When moving the P-100, first unplug the AC power cord and all other cables to prevent damage to cords and jacks. When removing plugs from terminals, always grip them directly rather than pulling on the cords.

- **Cleaning**

Use a slightly moist cloth and a neutral cleanser to clean the P-100. Do not use abrasive cleaners, waxes, solvents, or chemically treated cloths to clean the P-100, as these may damage the cabinet's finish or dull the keys.

- **AC Power**

The power requirement of your P-100 has been set to match the mains power supply voltage in your area. Make sure that your local AC mains voltage matches the voltage specified on the name plate on the rear panel of your P-100. If you have any doubts about voltage compatibility, please consult your local Yamaha dealer. If you plan to use your P-100 in an area with a different voltage, be sure to use an appropriate converter.

- **Electromagnetic interference**

Avoid using your P-100 near televisions, radios, or other equipment generating electromagnetic fields. Proximity to such equipment can cause the P-100 to malfunction, and may generate interference noise in the other appliance as well.

- **Extended disuse**

Electrical storms can cause power surges which can damage the P-100's circuitry even if the power switch is turned off. Therefore, it is best to disconnect the P-100's power cord from the AC outlet when you will not be using it for an extended period of time.

- **Service and Modification**

The P-100 contains no user serviceable parts. Never open the piano's cabinet or tamper with it in any way, as doing so can result in electrical shock or damage to the P-100. Refer all servicing to qualified YAMAHA service personnel.

- **Backup battery**

The P-100's internal settings are preserved by a lithium backup battery which has a life of approximately 5 years. (The battery's life may be somewhat shorter, depending on the time elapsed between your P-100's date of manufacture and the date you purchased it.) When the battery charge runs low, the "Er1" error message will appear in the LED display. If this display appears, save any settings you may want to keep using the bulk dump procedure, if possible, then contact your Yamaha dealer or a Yamaha service center to have the battery replaced.

# INTRODUCING THE P-100

## Upper panel

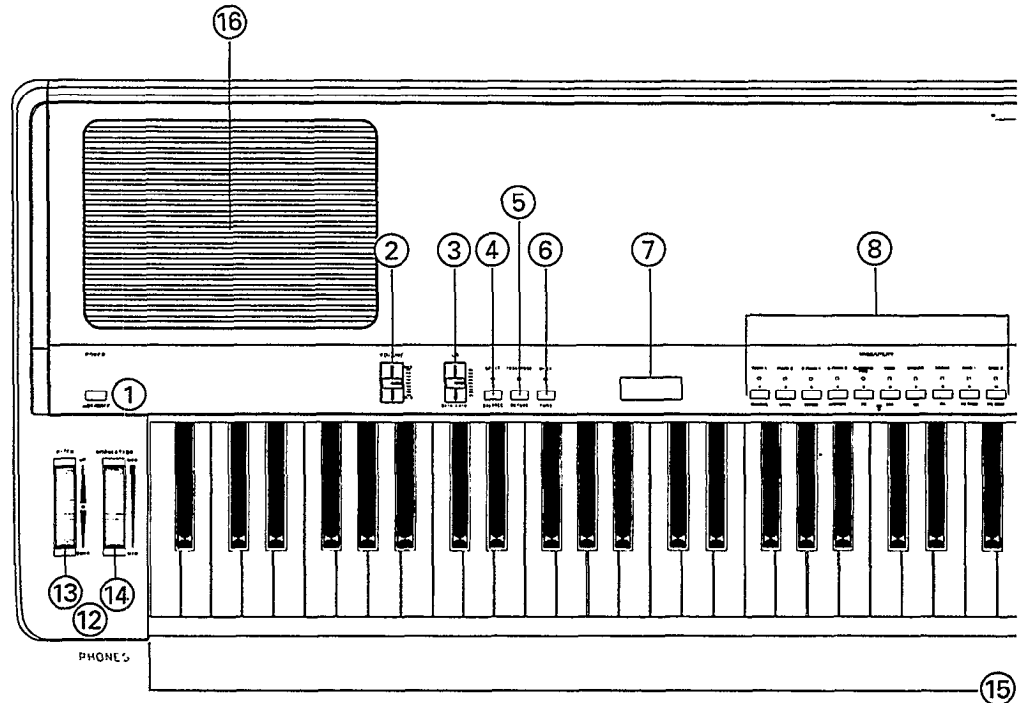

### ① [POWER] switch

This switch turns the P-100's power supply on and off. When the power is turned on, the number of the voice last selected will appear in the LED display ⑦, and the LED above the corresponding [VOICE/UTILITY] button will light.

### ② [VOLUME] slider

This slider controls the overall volume of sound output from the speakers ⑯ as well as that output via the LINE OUT jacks ⑲ on the rear panel of the P-100. Move the slider up to increase the volume, or down to decrease the volume.

### ③ [CS (DATA ENTRY)] slider

This continuous slider can be assigned to control data transmission for a variety of MIDI functions. It is also used to select a desired value when changing P-100 settings other than the current voice selection.

### ④ [SPLIT (BALANCE)] button

This button turns the Split voice mode on and off, and allows you to make settings related to Split mode operation. Also, in Dual or Split modes, it can be used in combination with the [DATA ENTRY] slider ③ to adjust the balance between the main and sub voices.

### ⑤ [TRANSPOSE (DETUNE)] button

The [TRANSPOSE] button turns the transpose function on and off, and lets you make settings related to this function. In Dual mode, it can be used to adjust the detune amount.

### ⑥ [MIDI (TUNE)] button

This button enables the P-100's transmission of MIDI messages. You will use it to select the MIDI Utility mode functions, and to transmit the P-100's current settings to another MIDI device as a MIDI bulk dump. It is also used to adjust the P-100's tuning and select keyboard velocity curve settings.

### ⑦ LED display

This three-digit numeric LED display shows the current main voice selection in Single, Dual, and Split modes. It also shows the values of various parameters when you change the P-100's settings.

### ⑧ [VOICE/UTILITY] buttons

These buttons let you select the voices you wish to play in Single, Dual, and Split modes. They are also used together with the [MIDI] button ⑥ to select the MIDI utility functions.

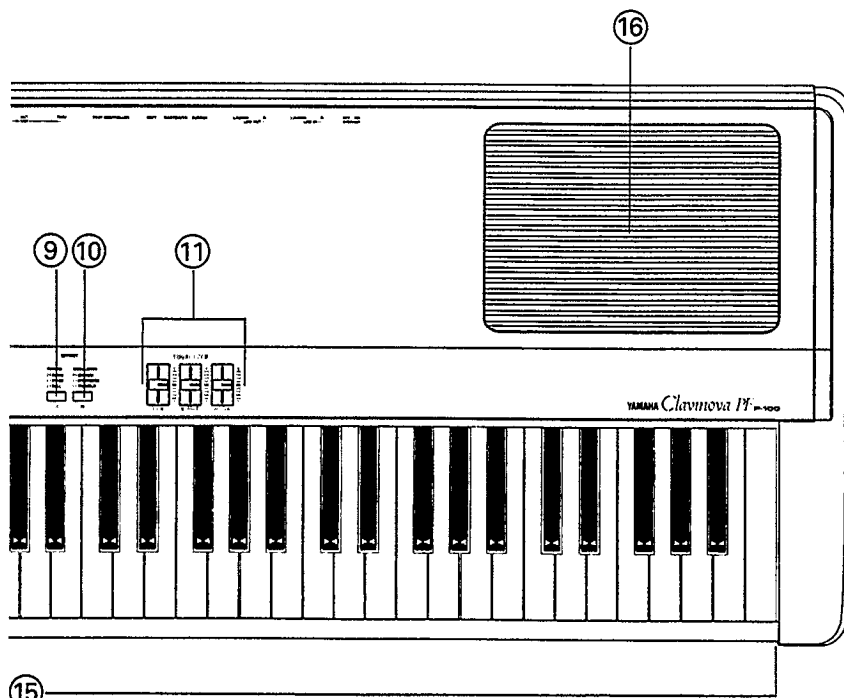

**⑨ [REVERB (-1)] button**

This button is used to change the reverb type and depth. It is also used to lower Utility mode and transpose function settings one step at a time.

**⑩ [MODULATION (+1)] button**

This button lets you change the modulation effect type and depth. Also, you can use it to raise Utility mode and transpose function settings one step at a time.

**⑪ [EQUALIZER] sliders**

These sliders adjust the level of the sound output by the P-100 in three bands: high, middle, and low. In Dual and Split modes, the changes you make will affect both voices being played.

**⑫ PHONES jack**

You can connect a stereo headphone set to the P-100 using this jack. The speakers ⑩ will turn off automatically when you plug in your headphones.

**⑬ [PITCH] wheel**

This wheel bends the pitch of notes you play up or down, returning automatically to the center position when you release it. It also transmits pitch bend messages to other instruments when MIDI transmission is enabled. Both voices are bent in

Dual mode. In Split mode, only the main voice is affected. A Utility mode function lets you change the pitch bend range to any value within a range of one octave.

**⑭ [MODULATION] wheel**

This wheel applies a vibrato effect to the notes you play when you roll it upward. (This effect does not apply to the two acoustic piano voices.) It also transmits modulation messages to other instruments when MIDI transmission is enabled. Both voices are modulated in Dual mode; only the main voice is affected in Split mode.

**⑮ Keyboard**

This 88-note Action Effect keyboard simulates the action and response of an acoustic piano keyboard.

**⑯ Speakers**

The P-100's two built-in 13 cm speakers each provide an output of 20 watts. If you wish, you can turn the speakers off using the SPEAKER switch ⑰ on the rear panel.

---

## Rear panel

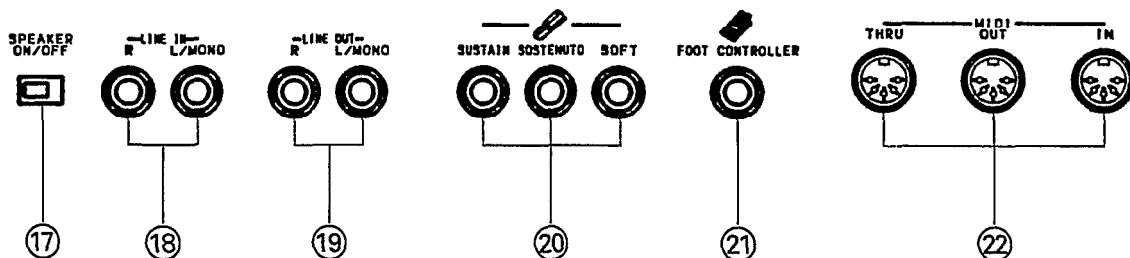

### ⑰ SPEAKER switch

This switch lets you turn off the internal speakers ⑰ mounted on the upper panel. It does not affect the output from the LINE OUT jacks ⑱.

### ⑱ LINE IN jacks

You can use these jacks to input line-level signals from another instrument, such as a drum machine, tone generator, or synthesizer, which you wish to play through the P-100's built-in speakers. Use the L/MONO jack when connecting only a single line.

### ⑲ LINE OUT jacks

These jacks output line-level signals which can be fed into an external amplifier, mixer, or other audio device. Use the L/MONO jack if your audio equipment has only one input.

### ⑳ Pedal jacks

These jacks let you connect up to three foot pedals and use them as sustain, sostenuto, and soft pedals. A single FC4 pedal is included with your P-100. If you wish to purchase additional foot pedals, be sure to use only Yamaha models FC4 or FC5.

### ㉑ FOOT CONTROLLER jack

This jack allows you to connect a foot controller (Yamaha FC7, available separately) for use as an auxiliary controller. The foot controller can be assigned to a variety of MIDI functions in the same manner as the [DATA ENTRY] slider ③.

### ㉒ MIDI terminals

These terminals allow the P-100 to communicate with other MIDI devices. To control the P-100 using a sequencer or another keyboard, connect the device in question to the MIDI IN jack. To control another device (such as a synthesizer or tone generator) using the P-100, connect the device to the MIDI OUT jack. The MIDI THRU jack simply echoes the data the P-100 receives from the MIDI IN jack, and is used to connect three or more MIDI devices in series.

# SETTING UP THE P-100

---

To prepare the P-100 for playing, follow the steps below to set it up and connect any peripheral equipment.

## 1. Plug in the power cord.

Plug the P-100's power cord into an AC outlet. Do not turn on, the [POWER] switch until you have finished making all of the connections below.

## 2. Connect the sustain pedal.

To use the supplied FC4 footswitch as a sustain pedal, insert its plug in the SUSTAIN jack on the rear panel. If you have purchased additional FC4 or FC5 footswitches, you should connect them to the SOSTENUTO and SOFT jacks at this time.

## 3. Connect a foot controller.

If you have purchased an FC7 foot controller for use as a MIDI foot controller, insert the plug of the switch in the FOOT CONTROLLER jack on the rear panel.

## 4. Connect external amplifiers.

If you wish to amplify the P-100 through an external audio system, connect the amplifiers to the LINE OUT jacks on the rear panel. Use the L/MONO jack for mono output, or both jacks for stereo output.

## 5. Connect other external audio equipment.

To amplify a device which outputs line-level audio signals (such as a drum machine, tone generator, or synthesizer) through the P-100's built-in speakers, connect cables from the output jacks of the device in question to the LINE IN jacks on the rear panel. Use the L/MONO jack for mono input, or both jacks for stereo input.

## 6. Connect MIDI devices.

Connect the P-100 to other devices using the MIDI terminals on the rear panel. Some examples of MIDI system connections are given on pages 46 through 49.

## 7. Connect headphones.

To listen to your P-100 through headphones, connect a stereo headphone set to the PHONES jack on the front panel. The built-in speakers will turn off automatically whenever headphones are connected to this jack.

## 8. Attach the music stand.

Attach the supplied music stand to the P-100 by inserting it into the groove along the rear edge of the upper panel. You can set the music stand at any desired position along the groove.

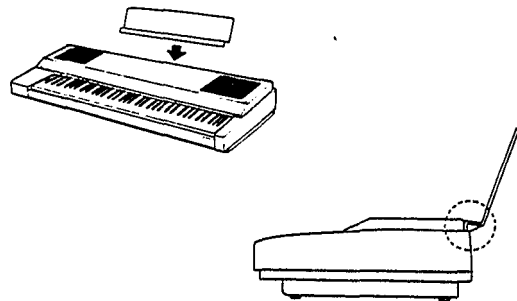

# PLAYING THE DEMO SONGS

Your P-100 is programmed with two songs that demonstrate the instrument's capabilities. You might want to try playing these songs to set the volume level and make sure that everything is working properly after you finish setting up the P-100. To do so, follow the steps below.

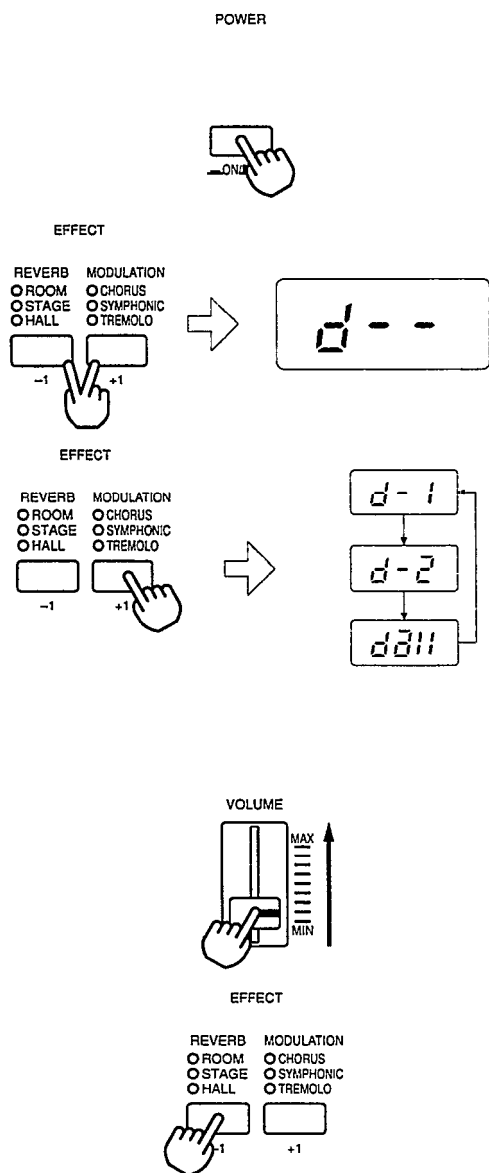

## 1. Turn on the P-100.

Move the [VOLUME] slider down to a low level, then press the [POWER] switch to turn on the P-100. If you have connected your P-100 to an external amplifier, you should turn the amplifier on after the P-100 in order to avoid damaging the speakers.

## 2. Enter Demo Play mode.

Press the [-1] and [+1] buttons simultaneously. The letter "d" appear in the display, followed by a pair of dashes.

## 3. Play a demo song.

Press the [+1] button once to select the first demo song, or twice to select the second song. The song you select will begin playing.

If you press the [+1] button three times, the word "all" will appear in the display and the P-100 will play all two demo songs in an endless loop.

If you don't press the [+1] button within three seconds, the P-100 will automatically exit the Demo Play mode.

## 4. Adjust the volume.

Move the [VOLUME] slider up while a demo song is playing to raise the volume to a suitable level.

## 5. Exit Demo Play mode.

If you select one of the two demo songs to listen to, the P-100 will exit the Demo Play mode automatically as soon as it finishes the song. To exit Demo play mode while a song is playing, the press the [-1] button.



### Switching between modes

You will not be able to enter the Demo Play mode — or any of the other play modes. for that matter — when the P-100 is in Utility mode. (The LED above the [MIDI] button will blink when the P-100 is in Utility mode.) To exit Utility mode, simply press the [MIDI] button.

Also, you will not be able to play the P-100 or use any of the Utility mode functions while the demo songs are playing. Be sure to press the [-1] button to leave the Demo Play mode when you are done listening to the demo songs.

# PLAYING THE P-100

## Selecting a voice

Once you've set up the P-100 and adjusted the volume level, you're ready to start making music. The standard mode for playing the P-100 is known as Single mode. In this mode, as its name implies, the P-100 plays only a single voice.

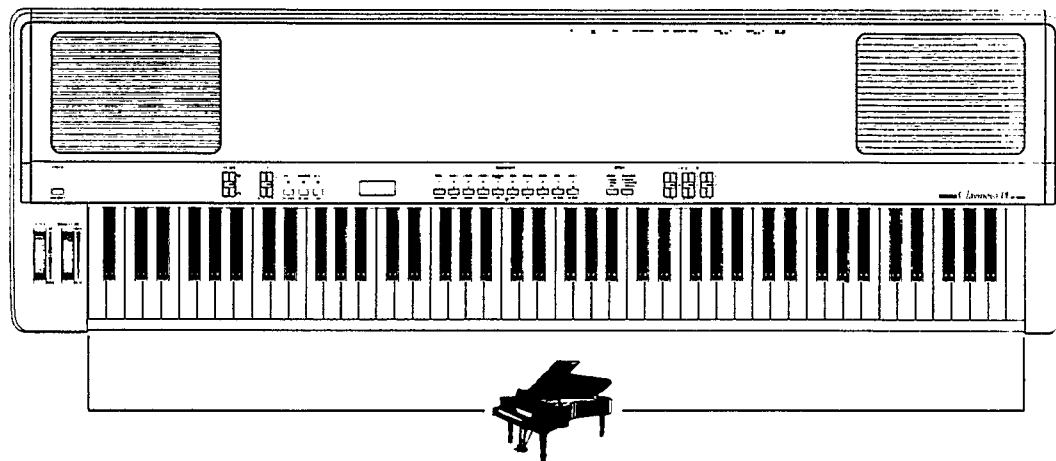

The P-100 plays only one voice in Single mode.

Playing the P-100 in Single mode is thus much like playing a normal acoustic piano. The biggest difference between the P-100 and an acoustic piano is the fact that the P-100 lets you choose between ten different voices.

NO.	VOICE	DESCRIPTION	SAMPLE TYPE	POLYPHONY
1	PIANO 1	Acoustic grand piano	Stereo/Mono	16/32
2	PIANO 2	Bright rock piano	Mono	32
3	E.PIANO 1	Traditional electric piano	Mono	32
4	E.PIANO 2	DX electric piano	Mono	32
5	CLAVINOVA TONE	A blend of harp and strings	Layered	16
6	VIBES	Vibraphone	Layered	16
7	STRINGS	Orchestral strings	Mono	32
8	ORGAN	Jazz organ	Mono	32
9	BASS 1	Acoustic wood bass	Mono	32
10	BASS 2	Electric bass	Mono	32

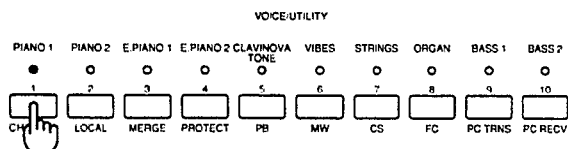

To play the P-100 in Single mode, you need only press the [VOICE/UTILITY] button for the voice you wish to play. The MIDI program change number assigned to the button you press will appear briefly in the display, followed by the number of the voice you've selected. (For details regarding the assignment of program change numbers to the [VOICE/UTILITY] buttons, refer to the explanation of the program change transmit table on pages 40 and 41.)





### Voice polyphony

As the table above shows, the P-100 produces 32 notes of polyphonic sound for seven of its voices. For convenience, we will refer to these voices as **32-note** voices.

The remaining three voices can produce only 16 simultaneous notes. The first voice, PIANO 1, is a stereo voice, created using stereo sampling techniques. If you wish, however, you can switch it to mono (for 32 notes output) by pressing and holding the [PIANO 1] button for a few moments. When you do so, the following display will appear briefly:



VOICE 1 MONO MODE DISPLAY  
(32 NOTE OUTPUT)

This display indicates that PIANO 1 has been switched to mono mode. This voice will remain in mono mode even if you select a different voice and come back to it (although the P32 display will not reappear). To switch it back to stereo mode, press and hold the [PIANO 1] button again. The display below will appear briefly.

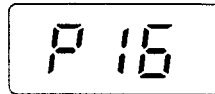

VOICE 1 STEREO MODE DISPLAY  
(16 NOTE OUTPUT)

The voice is also switched to stereo mode automatically each time you turn on the power to the P- 100.

The other two voices, CLAVINOVA TONE and VIBES, are actually layered sounds which combine two different tones in a single voice. They can produce a maximum of 16 simultaneous notes, and so are known (together with the PIANO 1 voice in stereo mode) as **16-note** voices.

## Using the reverb effect

Reverb adds warmth to sounds by creating the impression of an acoustic environment. The P-100 lets you select one of three different types of reverb to apply to each voice. The ROOM setting simulates the reverberation characteristics of a normal-sized room. STAGE reproduces the reverberations you would hear during a live on-stage performance. HALL gives a sense of a room with more space between the walls. Finally, the OFF setting — a fourth option which does not appear as a label on the upper panel — lets you play voices without any reverb.

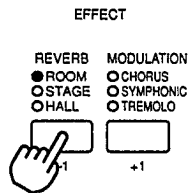

To change the reverb setting, simply press the [REVERB] button repeatedly. The P-100 will cycle through the possibilities, the LED next to the name of each reverb type lighting in turn to indicate your selection. (None of the LEDs will light when the OFF setting is selected.)

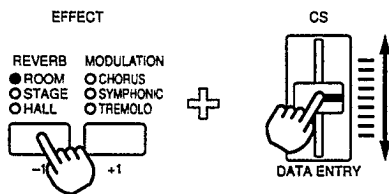

The P-100 also lets you set the **depth** or level of the reverb effect for each voice. The depth value appears in the display each time you select a different reverb type. To change the depth setting, move the [DATA ENTRY] slider while holding down the [REVERB] button.

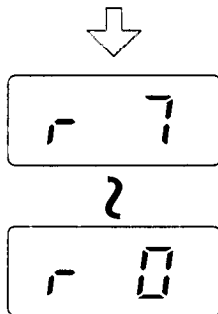

You can set the reverb depth to a level between 0 and 7. Setting the depth to 0 will effectively turn the reverb off, while a value of 7 will produce the most noticeable reverb.

The P-100 will remember your reverb type and depth settings individually for each of the ten voices. If, for example, you set the HALL effect at depth 6 for the PIANO 1 voice, then try playing the vibes using ROOM reverb at depth 4, the P-100 will automatically switch back to HALL depth 6 when you next select PIANO 1.

When you play two voices in Dual or Split modes, the P-100 will apply the main voice reverb type and depth settings to both voices, ignoring any settings which you may have made for the sub voice.

## Using the modulation effects

In addition to the reverb effect, the P-100 lets you apply one of three different modulation effects to its voices. CHORUS is a modulated delay effect that adds thickness to a voice, making it sound as though more than one instrument is being played. The SYMPHONIC effect is a heavier chorus. TREMOLO applies a tremolo effect to voices by modulating their output level. Finally, an OFF setting allows you to play without modulation.

These modulation effects have nothing to do with the vibrato effect which you can apply to voices using the [MODULATION] wheel. The procedure for turning this vibrato effect on and off is described on page 38.

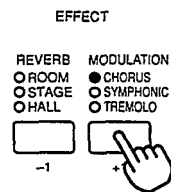

To change the current modulation effect setting, simply press the [MODULATION] button repeatedly. The LED next to the name of each modulation effect type will light in turn to indicate your selection. (None of the LEDs will light when the OFF setting is selected.)

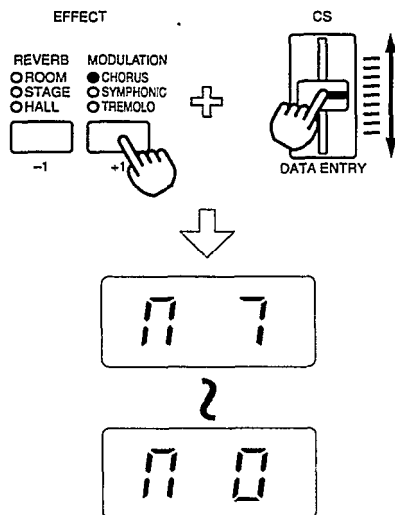

The P-100 also lets you set the depth of the modulation effect. The depth value appears in the display each time you select a different effect type. To do so, move the [DATA ENTRY] slider while holding down the [MODULATION] button.

You can set the modulation depth to a level between 0 and 7. Setting the depth to 0 will reduce the modulation depth to a minimum, whereas a value of 7 will result in the heaviest modulation.

The P-100 will remember modulation type and depth settings for each of the ten voices. When you play two voices in Dual or Split modes, the P-100 will apply the main voice modulation settings to both voices, ignoring any settings you have made for the sub voice.

## Adjusting the equalization

The P-100's equalizer works much like the three-band graphic equalizers found on many portable stereo sets. It allows you to adjust the P-100's output in three frequency ranges, LOW, MIDDLE and HIGH.

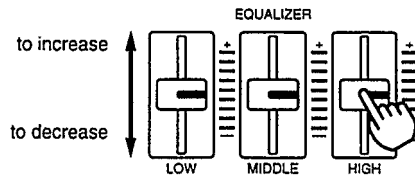

Slide the slider for each range up to increase the level of output, or down to decrease output in that range. The graph below should give you an idea how you can use the equalizer to modify the sound output by the P-100.

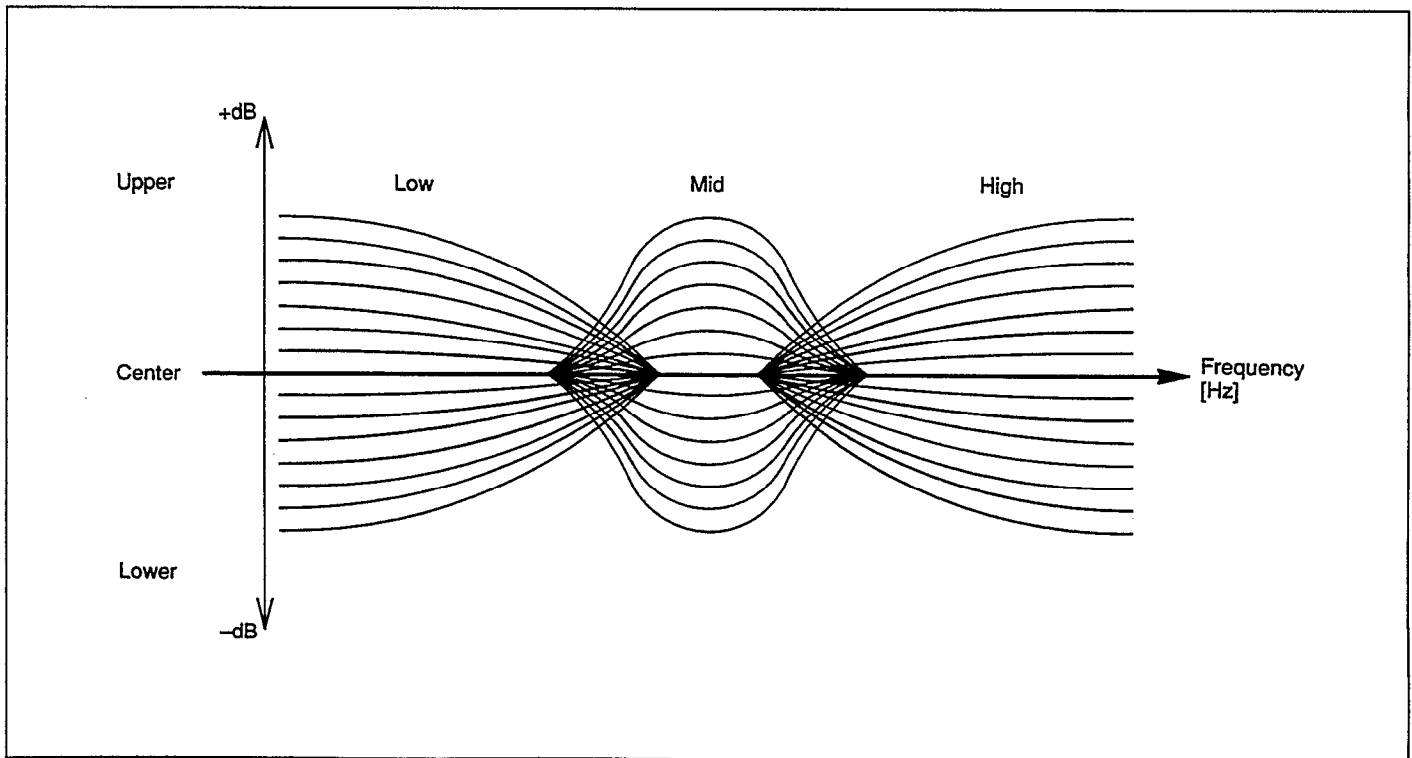

# DUAL MODE

## Selecting voices in Dual mode

In Dual mode, the P-100 sounds two of its voices in response to every note you play. Playing the P-100 in Dual mode is therefore like playing two keyboards at once. You could use this mode, for example, to play a melody with a piano underscored with the sound of strings.

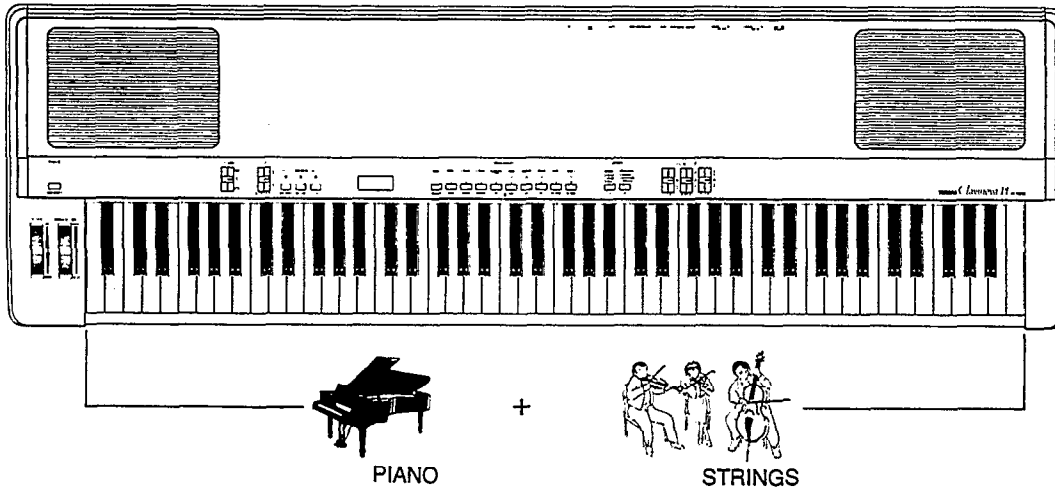

Dual mode is like playing two keyboards at once.

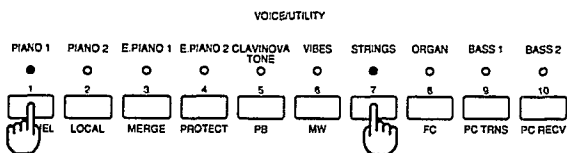

To enter Dual mode, press the [VOICE/UTILITY] button for one of the two voices you wish to play while holding down the button for the other voice. The MIDI program change number assigned to the button you press first will appear briefly in the display, followed by the number of the voice selected by that button. (For details regarding the assignment of program change numbers to the [VOICE/UTILITY] buttons, refer to the explanation of the program change transmit table on pages 40 and 41.)

When you select two voices to play in Dual mode, the voice you select first is known as the **main** voice, whereas the second voice is called the **sub** voice. This distinction is not important for playing, since both voices are produced simultaneously. However, you will want to keep it in mind when adjusting the voice balance and detune settings using the methods described on the following pages.



### Polyphonic capacity in Dual mode

Since the P-100 sounds two voices in response to every note you play, its voicing capacity in this mode will be lower than its normal capacity of 32 or 16 simultaneous notes.

When you play two 32-note voices in Dual mode, the P-100 will give you the same voicing capacity as when you play a 16-note voice in Single mode. Selecting one 32-note voice and one 16-note voice, however, will reduce the voicing capacity to 10 notes. Selecting two 16-note voices will cut it further, to only 8 notes.

---

## Adjusting the voice balance

The P-100's Dual mode is a useful feature. However, you may not always want to give the two voices equal emphasis. When playing a piano voice with strings, for example, you might want the strings to be little more than a murmur in the background, adding a delicate nuance to the piano without overwhelming it. You can accomplish this by adjusting the **voice balance**.

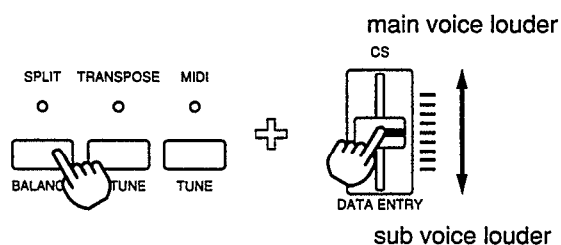

To change the voice balance, move the [DATA ENTRY] slider while holding down the [BALANCE] button.

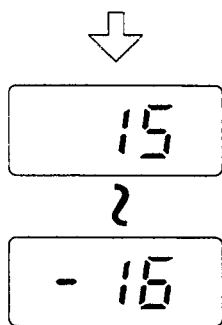

You can set the balance to a value from -16 to 15. Raising the balance value will make the main voice louder; lowering it will make the sub voice louder.

When you have set the balance at the desired level, release the [BALANCE] button. The P-100 will display the new setting for about a second, then exit the function automatically.

## Detuning the voices

The **voice detune** setting allows you to detune two voices slightly with respect to one another when playing them in Dual mode. This is especially useful when playing two similar voices, such as two piano sounds, together in Dual mode. By detuning the voices, you can produce a richer sound that will bring out the characteristics of the dual voices.

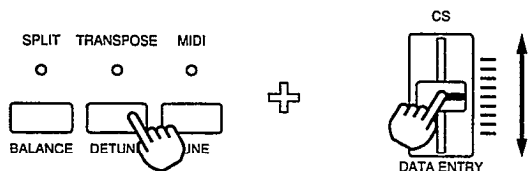

To detune two voices, move the [DATA ENTRY] slider while holding down the [DETUNE] button.

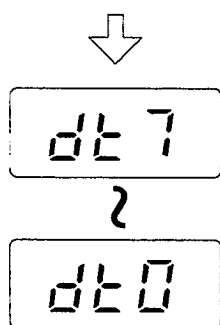

You can set a detune value from 0 to 7. With a value of 0, the voices are played at the same pitch; a value of 7 produces maximum detune.

When you have selected the desired detune setting, release the [DETUNE] button. The P-100 will display the new setting for about a second, then exit the function automatically.



### What happens when you detune voices

When you detune two voices in Dual mode, the main voice is raised above the keyboard's standard pitch by a certain amount, whereas the sub voice is lowered by an equal amount. The amount of pitch adjustment depends on the value you select, as shown in the following table. (Pitch adjustment values in the table are given in cents.)

VOICE	DETUNE SETTING							
	0	1	2	3	4	5	6	7
MAIN	0	+1.56	+3.12	+4.68	+6.24	+8.58	+11.70	+15.60
SUB	0	-1.56	-3.12	-4.68	-6.24	-8.58	-11.70	-15.60

At the maximum detune setting, the voices are each detuned by about one-sixth of a semitone.

# SPLIT MODE

## Entering Split mode

The P-100's Split mode, like its Dual mode, lets you play two voices at once. In this mode, however, the two voices are played independently rather than together. You could use this mode, for example, to play the vibes with your right hand and a wood bass with your left.

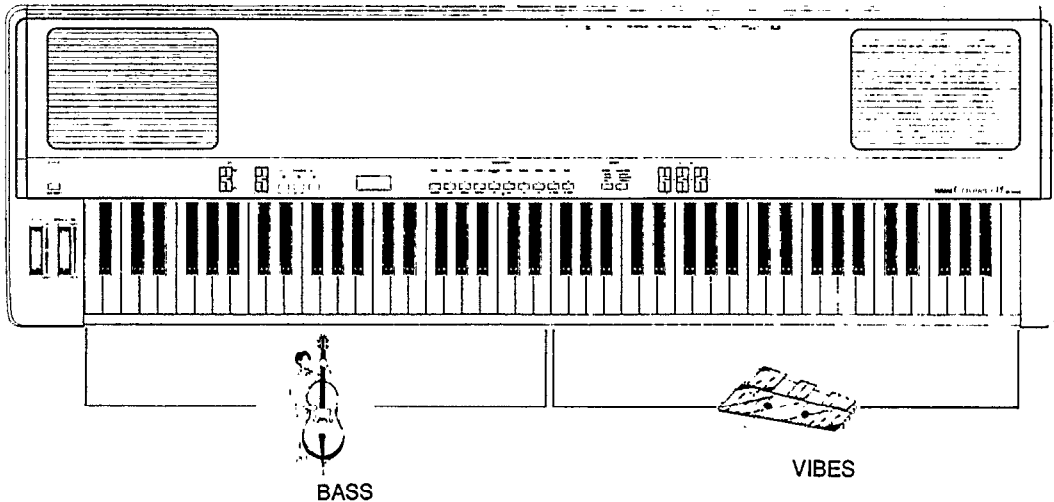

Split mode is like playing two different instruments.

As in Dual mode, the two voices you play in Split mode are referred to as the main and sub voices. These voices are assigned to separate areas of the keyboard, known as the **main** and **sub keyboard areas**, which are separated at a key known as the **split point**.

To enter Split mode, simply press the [SPLIT] button. The keyboard will split into two areas, one playing the main voice you selected in Single or Dual mode, and the other playing the voice which was last selected as the Split mode sub voice. (BASS 1 was selected as the default sub voice when your P-100 left the Yamaha factory.)

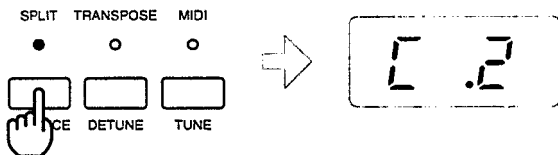

When you turn Split mode on, the LED above the [SPLIT] button will light, and the current split point key will appear briefly in the display. The P-100 will now play two voices using the current sub voice and split point settings.

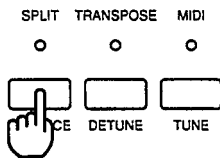

To turn Split mode off, press the [SPLIT] button again. The LED above the [SPLIT] button will go out and the P-100 will return to Single or Dual mode, playing the voice you have selected as the main voice.

The fact that the procedure for selecting voices is separate from that for entering and leaving Split mode makes this mode more convenient. It means that you can switch the sub keyboard area on and off as needed, playing the main voice across the entire keyboard during a song's verse and chorus, for example, then adding the sub voice for an intricate two-part solo.

The method for selecting voices in Split mode is described on the following page. You can also change the location of the split point, and determine whether the main keyboard area will be above or below this point, using the procedure on pages 16 and 17.

Please note that the pitch bend and modulation wheels and the sustain, soft, and sostenuto pedals will only effect the main voice when you use these controls in Split mode.



## Selecting voices in Split mode

When you press the [SPLIT] button to enter Split mode, the voice you were playing in Single mode (or the main voice, if you were playing in Dual mode) will be assigned by default to the main keyboard area. At the same time, the voice which was last selected as the Split mode sub voice will be assigned to the sub keyboard area.

Once you have entered Split mode, however, you can change the main and sub voices independently of one another. The procedure for changing the main voice is exactly the same as that for selecting a voice in Single mode.

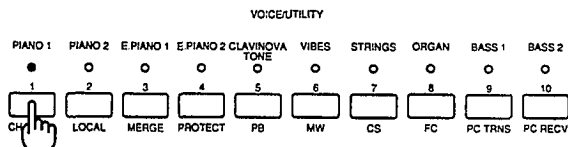

To change the main voice, press the [VOICE/UTILITY] button for the voice you wish to play. The MIDI program change number assigned to that button will appear briefly in the display, followed by the number of the voice you've selected. (For details regarding the assignment of program change numbers to the [VOICE/UTILITY] buttons, refer to the explanation of the program change transmit table on pages 40 and 41.)

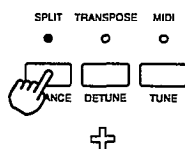

To select the sub voice, press a [VOICE/UTILITY] button while holding down the [SPLIT] button. The MIDI program change number assigned to the [VOICE/UTILITY] button you press will appear briefly in the LED display, followed by the number of the currently selected main voice.

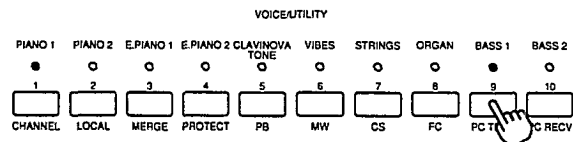

You can select a Split mode sub voice while the P-100 is in Single or Dual modes, if you wish. If you do so, the P-100 will remain in Split mode after you make your selection. This lets you change the sub voice selection as you enter Split mode, for smooth transitions between parts of a song.



### Adjusting the voice balance

The need for adjusting the balance between two voices in Split mode may not seem as obvious as in Dual mode. After all, you will probably play the voices with different hands. Still, playing different voices in Split mode may sometimes call for you to play very softly with one hand while playing loudly with the other. Should you find this difficult, you might find it easier to set the level for each voice using the balance function.

If you would like to give this shortcut a try, adjust the balance value using the method described on page 13. Raising the balance value will increase the volume of the voice in the upper keyboard area, whereas lowering it will increase the voice in the lower keyboard area.

## Changing the split point

By adjusting the location of the split point, you can adjust the note ranges of the main and sub keyboard areas to suit the parts you're playing. Also, the adjustment operation also allows you to specify whether the main voice will play above or below the split point. The main keyboard area is normally above the split point. However, there may be cases when you'll want to play the main voice below the split point.

Imagine, for example, a song arrangement which calls for you to play the vibes with a piano bass line. The P-100's Split mode can handle this requirement quite well. After the bridge, however, there is a flashy piano solo with sweeping runs that take you from one end of the keyboard to the other. You can do this by selecting the piano as the main voice, and assigning it to the lower keyboard area. You will then be able to switch from Split mode to the Single mode for the solo, then back to Split mode again, by simply pressing the [SPLIT] button.

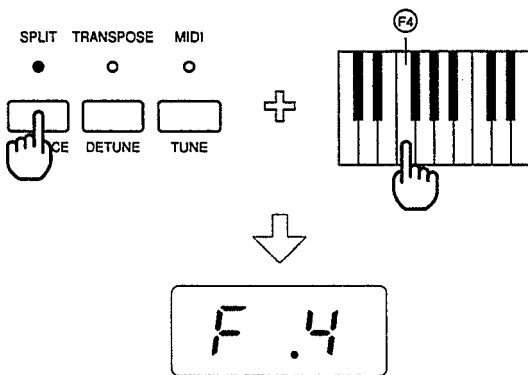

To change the split point, press the key on the keyboard where you want to locate the split point while holding down the [SPLIT] button. To set the split point at F4, for example, you would press the F4 key while holding down the [SPLIT] button.

The new split point setting will then appear in the display.

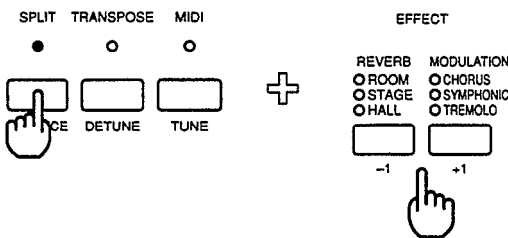

(You can also raise or lower the current split point setting one semitone at a time by pressing the [-1] or [+1] buttons while holding down the [SPLIT] button.)

If you want to change the location of the main keyboard area, you must do so when you change the split point. This is done by simply pressing a key above or below the split point.

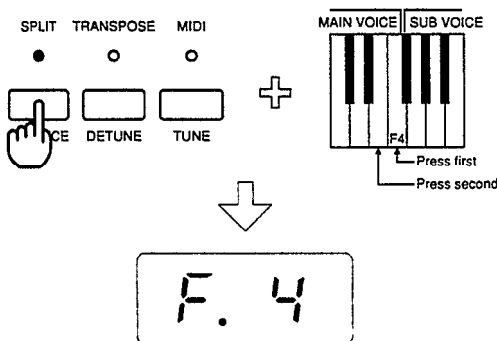

To play the main voice below the split point, for example, first set the split point as described above. Then, while still holding the [SPLIT] button and the split point key, press a key anywhere below the split point on the keyboard.

The dot which appear in the display will move to a position just after the letter.

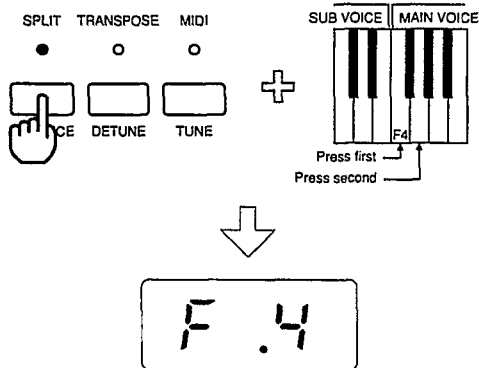

To return the main voice to the area above the split point, the second key you press should be above rather than below the split point. The dot in the display will move back to its normal position before the number.

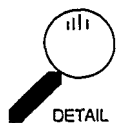

### What about the split point key?

The key that you press to select the split point will always be included in the main keyboard area. Thus, if you select F4 as the split point and then set the main keyboard below this point, the main voice will play all notes up to and including F4, and the sub voice will play any notes from F#4 on. If you set the main keyboard above this point, however, the sub voice will play any notes up to E4, and the main voice will play notes from F4 up.

# ADJUSTING THE KEYBOARD

## Tuning the P-100

Electronic pianos have one advantage over their acoustic counterparts: they are much easier to tune. You can fine-tune the P-100's keyboard upward or downward within a range of about 100 cents.

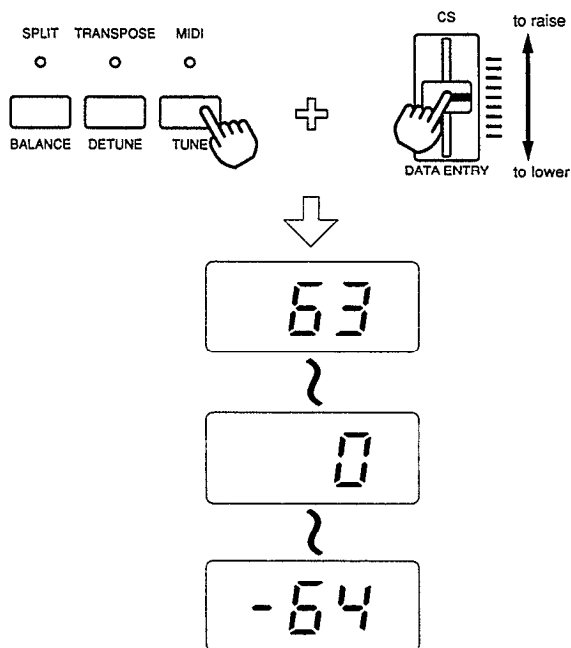

You can set the tuning to a value from -64 to 63. Each step raises or lowers the tuning by about 0.78 cents. The default value is 0, which corresponds to 440 Hz at A3.

When you locate an appropriate tuning value, release the [TUNE] button. The P-100 will display the new value for about a second, then exit the function automatically.

## Selecting a velocity curve

Although the P-100's keyboard feels like an acoustic piano keyboard, it works on quite different principles. Since the P-100 is an electronic piano, it must determine how fast a key is being pressed — that is, the **velocity** of a note — in order to know how hard the note was played.

The P-100 can respond to your playing velocity in a number of ways, depending on your selection of a **velocity curve**. This feature lets you adjust the keyboard response to suit your playing style. The P-100 has four different velocity curve settings: NORMAL, SOFT, HARD, and FIXED.

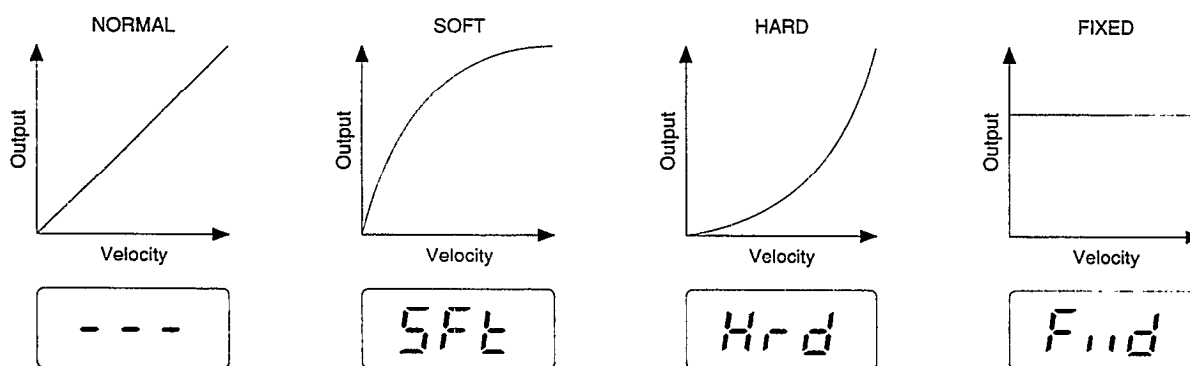

The NORMAL velocity curve is a linear progression: the harder you hit a key, the louder the resulting sound will be. The SOFT curve produces loud volume with a relatively soft touch. The HARD curve, on the other hand, requires that you hit the keys fairly hard to produce loud notes. Finally, the FIXED velocity curve produces the same volume no matter how hard you hit the keys. This last option is useful when playing the organ voice.

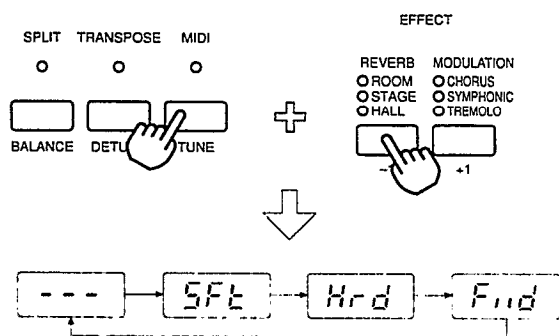

To select a different velocity curve, press the [REVERB] button while holding down the [TUNE] button. The current velocity curve setting will appear in the display.

Press the [REVERB] button repeatedly without releasing the [TUNE] button. The P-100 will cycle through the possible velocity curve settings.

When the name of the desired curve appears, release the [TUNE] button. The P-100 will display the new setting for about a second, then exit the function automatically.

## Using the transpose function

The P-100 has a transpose function which makes transposing between keys easy. To use this function, you may want to first set the transpose amount using the procedure described on the following page. Once you have set the transpose amount to the desired value, you can turn the transpose function on and off as needed using the [TRANSPOSE] button.

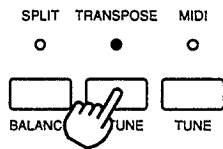

To turn the transpose function on, press the [TRANSPOSE] button. The LED above this button will light, indicating that the P-100 is transposing.

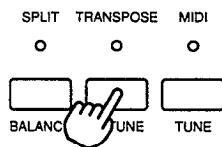

To turn the transpose function off, press the [TRANSPOSE] button once again. The LED above the button will go out and the P-100 will stop transposing.



### Transpose amount settings

It is worth noting at this point that the P-100 actually has five transpose amount settings. The first, described on the following page, sets the transpose amount for the entire keyboard in Single mode, and for the main voice in Dual and Split modes. The second and third settings, described on page 23, control the transpose amounts for the sub voice in Dual and Split modes. The fourth and fifth transpose amount settings control the transposition of note information transmitted to external instruments as MIDI messages. These settings are described in detail on page 30.

All five of the transpose amount settings are activated as a group when you press the [TRANSPOSE] button. They cannot be turned on independently of one another. You will not be able to turn the transpose function on if you set all of the transpose amounts to zero.

## Setting the transpose amount

The P-100's default main voice transpose setting is 12. This means the P-100 will transpose the notes you play up an octave after you press the [TRANSPOSE] button to activate the transpose function.

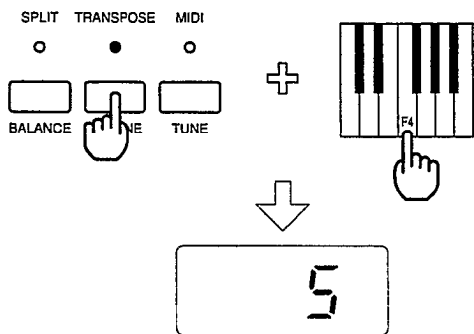

To change the transpose amount, hit one of the keys between C1 and C5 on the keyboard while holding the [TRANSPOSE] button down. The key you hit should be a number of semitones above or below C3 (middle C) equal to the number of semitones you wish to transpose the notes you play. To transpose up five semitones from C to F, for example, you would hit F3, which is five semitones above middle C on the keyboard.

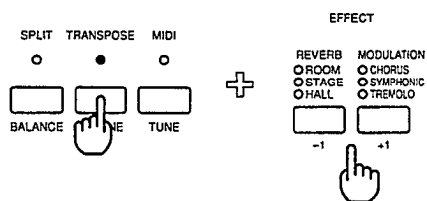

You can also change the transpose amount setting by pressing the [+1] or [-1] buttons while holding down the [TRANSPOSE] button. Each time you press one of these buttons, you will raise or lower the transpose amount by a semitone.

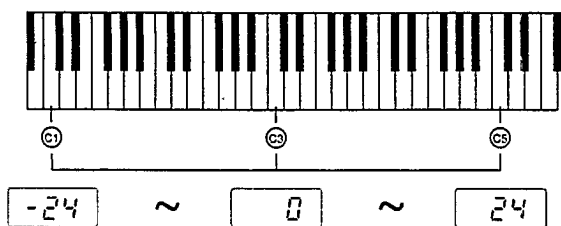

The P-100 can only transpose within a range of four octaves, from -24 (C1) to 24 (C5). If you press a key below C1 or above C5, the P-100 will set the transpose value to -24 or 24.

When you have set the transpose amount to the desired value, release the [TRANSPOSE] button. The P-100 will display the new value for about a second, then show the number of the currently selected voice.

If you set the transpose amount before actually turning the transpose function on, the P-100 will assume that you want to transpose using this value, and leave the transpose function turned on after you complete the setting. This convenient feature allows you to turn on the transpose function and set the transpose amount in a single operation.

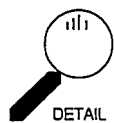

### Notes at the end of the keyboard

The P-100 can only play notes which fall within its 88-key range. When you use the transpose function, therefore, a number of keys at one end of the keyboard will not fall within this range.

When you transpose up, the keys at the upper end of the keyboard which do not fall within this range will repeat the uppermost octave (C#6 to C7). When you transpose down, the keys at the lower end of the keyboard will repeat the lowermost octave (A-1 to G#0).

---

## Transposing in Dual and Split modes

Transposing is a little more complex in Dual and Split modes than it is in Single mode, because the P-100 allows you to transpose the sub voice independently of the main voice. The default sub voice transpose amounts are set to 12 for Dual mode, and 0 for Split mode.

The procedure for changing the sub voice transpose amounts is similar to that described for the main voice, except that you must press and hold the [TRANSCOPE] and [SPLIT] buttons rather than just the [TRANSCOPE] button. Use the operation below while the P-100 is in Dual mode to change the setting for the Dual mode sub voice, or in Split mode to change the setting for the Split mode sub voice. You cannot change the sub voice settings while the P-100 is in Single mode.

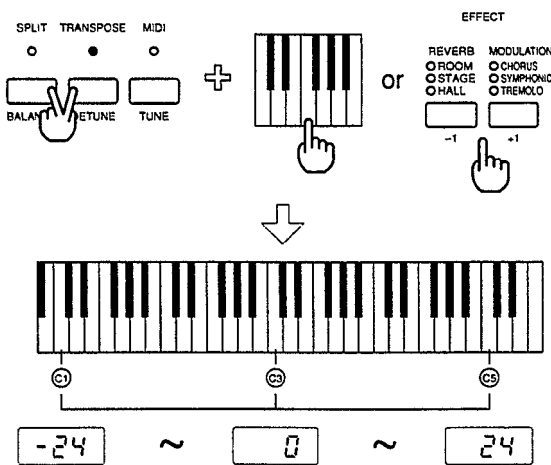

Press and hold first the [TRANSCOPE] button, then the [SPLIT] button. Then adjust the transpose amount by pressing one of the keys on the keyboard, or using the [-1] or [+1] buttons, as described on the preceding page.

You can set the transpose amount for the sub voice anywhere within a range of four octaves, from -24 (C1) to 24 (C5). As with the main voice transpose amount, if you try to set the transpose amount by pressing a key below C1 or above C5 on the keyboard, the P-100 will react as though you pressed C1 or C5.

When you have set the sub voice transpose amount to the desired value, release the [TRANSCOPE] and [SPLIT] buttons. The P-100 will display the new value for about a second, then show the number of the currently selected voice. As with the main voice setting, the P-100 will assume that you want to transpose using this value, and leave the transpose function turned on after you complete the setting.

Please note that the Dual mode sub voice setting will change automatically to match the main voice whenever you change the main voice transpose setting while the P-100 is in Dual mode. This allows you to change the transpose setting for both voices with a single operation.

Once you have set transpose amounts for both the main and sub voices, pressing the [TRANSCOPE] button will turn the transpose function on and off for both voices in Dual or Split mode. It is not possible to turn the function off for only one of the two voices in these modes.





### **Why transpose the sub voice?**

This function may not seem very necessary at first glance. After all, transposing one voice up or down a few semitones while leaving the other untransposed would only complicate playing unnecessarily — unless you want to try sightreading a part written for, say, a saxophone with your right hand and a bass line with your left.

However, there are in fact many interesting ways to use this feature. In Dual mode, for example, you could use it to play two-note harmonies, lowering the sub voice so that it plays a fifth or an octave below the main voice.

In Split mode, too, you could transpose the sub voice up or down two octaves and play it in the same pitch range as the main voice. This would allow you to play a two-handed duet, for example, performing a melody with one hand and echoing it using a different voice played by the other.

# MIDI KEYBOARD CONTROL FUNCTIONS

---

## What is MIDI?

MIDI is an acronym for Musical Instrument Digital Interface. This is the name of an international standard which was instituted during the 1980s to provide for the communication of data between electronic musical instruments. The MIDI standard allows instruments such as synthesizers, tone generators, and drum machines — not to mention electronic pianos such as the P-100 — to communicate with each other, and to be controlled by sequencers or computers.

MIDI is a rather involved standard, and we will not attempt to explain all of its provisions in this short manual. You will find it easier to put MIDI to work, however, if you understand a few of the basic concepts behind the standard. Two of the most important concepts in MIDI are those of **channels** and **messages**.

## Channels

The MIDI standard provides 16 different channels for the transmission of data between musical instruments. All **MIDI keyboards** are capable of transmitting data on at least one of these channels. Sequencers and MIDI-equipped computers, by contrast, generally transmit data on several channels at once, each channel being assigned to a different part of an ensemble performance.

It is the task of **tone generators** to receive MIDI data from keyboards, sequencers, or computers and produce sounds in response. Some tone generators, known as **multitimbral** tone generators, can play different sounds in response to data received on more than one channel. If this makes you think of the P-100's Dual and Split modes, then you're right on target: the P-100 actually consists of a MIDI keyboard and a multitimbral tone generator capable of producing two timbres simultaneously. We'll take a detailed look at how these hardware elements work together in the next section.

## Messages

All of the data which is transmitted between MIDI devices takes the form of MIDI messages of one sort or another. The messages most closely associated with the actual performance of music are called **channel voice** messages. These include **note on** and **note off** messages, which tell a tone generator which notes to play, and when to start and stop playing them: **control change**, **pitch bend**, and **aftertouch** or **key pressure** messages, which indicate how a keyboard's control functions are being operated: and **program change** messages, which tell a tone generator to switch to another sound or set of sounds.

Channel voice messages must be transmitted on a channel which will be received by the tone generator for which they are intended. They are thus different from **system** messages, which are transmitted on all channels and received by all of the devices in a MIDI system.

System messages, too, come in a number of varieties. There are **system realtime** messages, which are used to start, stop, and synchronize the sequencing devices in a MIDI system. Another variety, **system exclusive** messages, allows for the transmission of data specific to individual devices. This data can be either individual parameter settings, which are transmitted as **parameter change messages**, or large blocks of settings, which are usually referred to as **bulk dumps**.

There are several other kinds of MIDI messages that we will not go into here. When using the P-100's MIDI functions, you will be concerned mainly with only two types of messages: channel voice messages and system exclusive messages. To learn what other sorts of messages the P-100 supports, and how their corresponding functions are implemented, you can refer to the MIDI Data Format and MIDI Implementation Chart sections at the back of this manual.

---

## Terminals

Before we jump into a detailed description of the P-100's MIDI configuration, we should consider the hardware used to communicate MIDI data. MIDI devices transmit messages to each other via cables, which are connected to the devices using specially-shaped sockets called MIDI terminals. There are three types of MIDI terminals: **IN**, **OUT**, and **THRU**.

Not all MIDI devices have three MIDI terminals; but most, like the P-100, do. A device with all three terminals will receive incoming data through its MIDI IN terminal, and output its own data through the MIDI OUT terminal. The MIDI THRU terminal merely echoes the data received at the MIDI IN terminal. This allows the device to be connected in the middle of a "daisy chain" of instruments, so that the third instrument in the chain will receive the data transmitted by the first instrument rather than that transmitted by the second.

Some MIDI instruments, such as the P-100, have a **MIDI merge** feature which essentially combines the functions of the MIDI OUT and MIDI THRU terminals in a single terminal. In the case of the P-100, when the MIDI merge function is turned on, the MIDI OUT terminal will output a combination of the P-100's own data and the messages it receives from the MIDI IN terminal. Any instrument receiving this data will be controlled by both the P-100 and the device connected to the P-100's MIDI IN terminal. One possible application of this handy feature is given on page 48.

## The P-100's MIDI configuration

Now that we have gone over the basic concepts involved, you might be interested to take a look at the way the P-100 uses MIDI to produce music. We mentioned on the previous page that the P-100 consists of a MIDI keyboard connected to a multitimbral tone generator, which is capable of producing two timbres at once. In fact, the P-100's three playing modes — Single, Dual, and Split — are nothing more than different ways of combining these MIDI hardware elements.

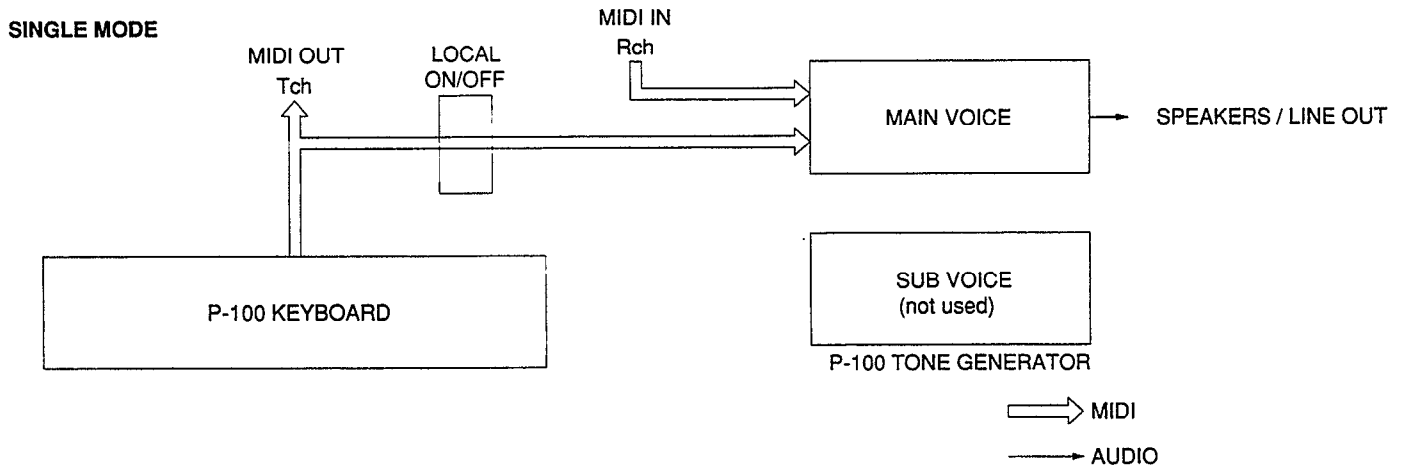

In **Single mode**, the P-100 uses only one of its two timbres. The keyboard sends MIDI channel voice messages to the tone generator to control the main voice timbre. It also outputs the same messages from the MIDI OUT terminal on the channel you select as the transmit channel (Tch). Channel voice messages which are input at the MIDI IN terminal using the channel designated as the receive channel (Rch) will also be sent to the tone generator to control the main voice.

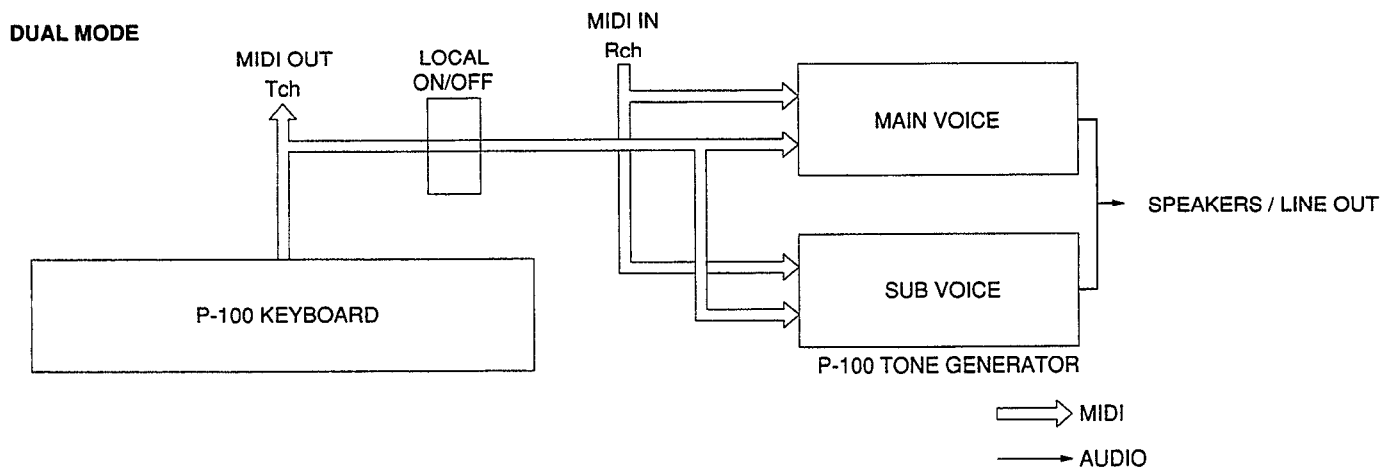

Both timbres are used in **Dual mode**. Since the two timbres play in unison, both the main voice and the sub voice will respond in the same way to any channel voice messages that are received from the P-100's keyboard or the MIDI IN receive channel.

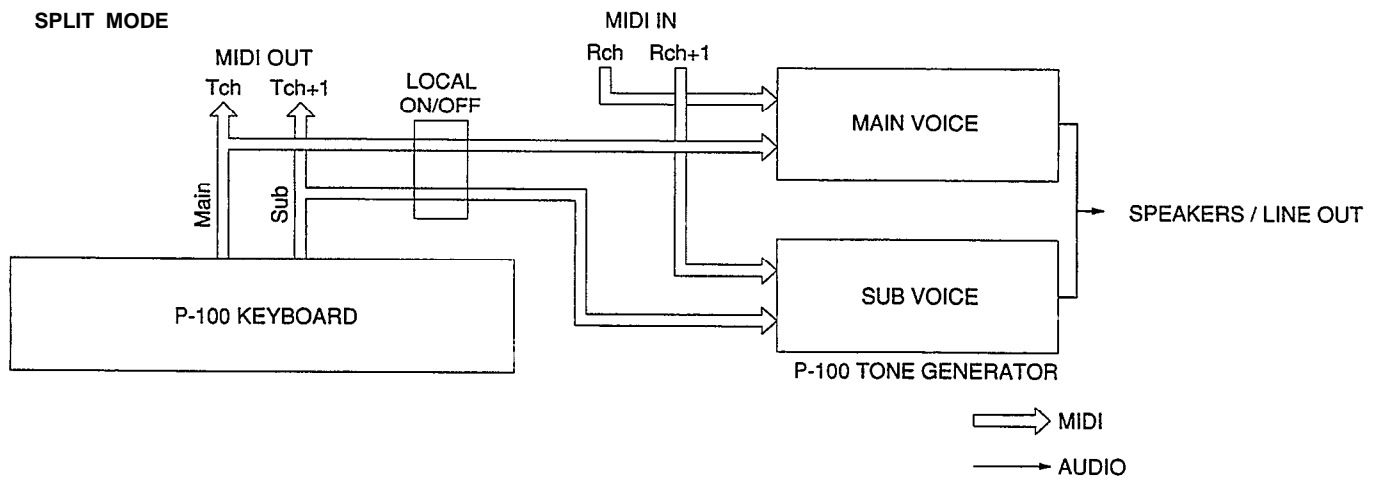

The situation becomes more complex in **Split mode**. Since the two timbres play independently rather than in unison, two MIDI channels are needed to control them. For this reason, the P-100 divides its keyboard into two areas, known as the main and sub keyboard areas. Channel voice messages from the main keyboard area are sent to the main voice and output on the transmit channel (Tch) as in Single mode. Messages from the sub keyboard area are sent to the sub voice and output using the next higher MIDI channel (Tch+1). Since the P-100 thus outputs its messages on two MIDI channels in Split mode, you can use the P-100's keyboard in this mode to control two of an external tone generator's timbres.

Data received at the MIDI IN terminal is handled in the same manner: channel voice messages on the receive channel (Rch) are sent to the main voice, whereas messages on the next channel up (Rch+1) are sent to the sub voice.

In any of the P-100's three modes, you can turn off the connection between the P-100's keyboard and tone generator sections by setting the **local control** function off. Doing so will stop the P-100's tone generator from responding to notes played on the keyboard, however, the keyboard will still transmit messages via the MIDI OUT terminal, and the tone generator will respond to messages received at MIDI IN. The procedure for turning off the local control function is described in the next chapter.

## Enabling MIDI transmission

We described in the previous section how the P-100 normally transmits channel voice messages for the notes you play on the keyboard. The LED above the [MIDI] button remains lit while this function is enabled to remind you that the P-100 is transmitting. Should you wish to turn this function off for some reason, there is an easy way to do so: just press the [MIDI] button.

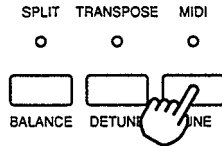

When you press the [MIDI] button, the LED will go out, indicating that MIDI transmission has been disabled. This will prevent transmission of channel voice messages on both channels (Tch and Tch+1) when you're playing in Split mode. It will not affect the transmission of bulk dumps, however; nor will it block the reception of data from the MIDI IN jack.

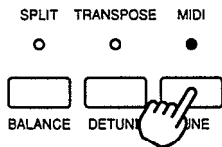

To re-enable transmission, simply press the [MIDI] button again. Keep in mind, though, that you cannot enable transmission by pressing the [MIDI] button if the transmit channel (Tch) has been turned off. (The procedure for selecting a transmit channel is described on page 32.)

## Selecting a MIDI velocity curve

The P-100 lets you assign a separate velocity curve for data transmitted from the MIDI OUT terminal. This allows the P-100 to interpret the velocities of the notes you play differently for an external tone generator than it does for its internal voices.

You might want to try this feature, for example, to play the internal STRINGS voice together with a brass sound produced by an external tone generator. By using the SOFT velocity curve with the STRINGS voice and the HARD curve with the brass, you could have the brass keep a low profile while you're playing normally, then suddenly blare out when you hit a note hard, creating a dramatic orchestral effect.

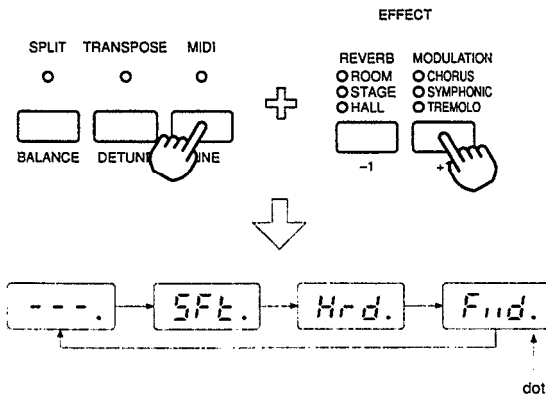

The procedure for selecting a MIDI velocity curve is the same as that described on page 20, except that you must press [MODULATION] rather than the [REVERB] button while holding down the [MIDI] button. A dot will appear in the lower right corner of the display to indicate that you have selected the MIDI velocity curve setting.

Press the [MODULATION] button repeatedly without releasing the [MIDI] button. The P-100 will cycle through the possible velocity curve settings: normal, soft, hard, and fixed.

When the name of the desired curve appears, release the [MIDI] button. The P-100 will display the new setting for about a second, then exit the function automatically.

## Using the MIDI transpose function

In addition to the transpose settings for the two voices produced by its internal tone generator, the P-100 lets you assign separate transpose amounts for notes it transmits from the MIDI OUT terminal. This gives you a total of five transpose settings: three for the internal main and sub voices, one for messages transmitted on the transmit channel (Tch), and one more for the messages transmitted on the Tch+1 channel (which corresponds to the Split mode sub voice) in Split mode. By dividing the transpose function into five separate settings, the P-100 gives you full control over the pitch of notes produced by external tone generators as well as those it plays itself.

The procedures for setting the MIDI transpose amounts are similar to those described on pages 22 and 23, except that you must press and hold the [MIDI] button together with the other buttons.

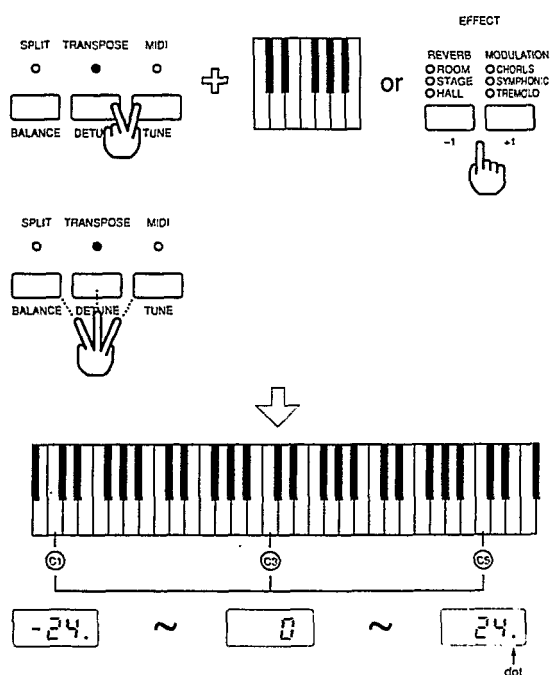

To set the Tch transpose amount, press and hold first the [TRANPOSE] button, then the [MIDI] button. Then, without releasing these buttons, set the transpose amount by pressing a key on the keyboard or using the [-] and [+] buttons.

When setting the Tch+1 transpose amount, press and hold the [TRANPOSE] button, then the [MIDI] and [SPLIT] buttons, before you make the adjustment.

You can set the MIDI transpose amounts anywhere within a range of four octaves, from -24 (C1) to 24 (C5). (In either case, a dot will appear in the lower right corner of the display to indicate that you have selected one of the MIDI transpose function settings.) When you set the transpose amount, remember that the P-100 will react to keys below C1 or above C5 as though you had pressed C1 or C5.

Once you have set the desired transpose amount, release the [MIDI] and [TRANPOSE] buttons. The P-100 will display the new value for a moment, then exit the function automatically. The transpose function will remain turned on for all notes until you turn it off again.

Whenever you press the [TRANPOSE] button thereafter, you will turn the transpose function on and off for all voices, both internal and external, at once. It is not possible to turn the MIDI transpose function on and off independently of the internal transpose settings.



### Do I have to change all the transpose settings?

Not necessarily. The P-100 was designed so that the MIDI transpose amount settings will follow the internal transpose settings when you make any changes. Whenever you change the main voice transpose setting, the MIDI Tch transpose setting will automatically be set to the same value. Moreover, if you change the sub voice transpose setting while playing in Split mode, the Tch+1 transpose setting will also be set to the new amount. This at least ensures that any external tone generators will at least be playing the same notes as the P-100's internal voices. If you want your external tone generator to play at a different octave, though, you will have to make that setting by hand.

# MIDI UTILITY MODE SETTINGS

---

## MIDI Utility mode

In addition to its Single, Dual, Split, and Demo Play modes, the P-100 has a MIDI Utility mode which allows you to make a number of settings related to MIDI control functions. Below is a listing of the settings available in this mode:

SETTING DESCRIPTION	BUTTONS
Transmit and receive channels	MIDI + CHANNEL
Local control on/off	MIDI + LOCAL
MIDI merge function on/off	MIDI + MERGE
Bulk protect on/off	MIDI + PROTECT
Pitch bend range	MIDI + PB
Modulation wheel on/off	MIDI + MW
CS slider assignment	MIDI + CS
Foot controller assignment	MIDI + FC
Program change transmit table	MIDI + PC TRNS
Program change receive table	MIDI + PC RECV

You can enter MIDI Utility mode by pressing the appropriate [VOICE/UTILITY] buttons while holding down the [MIDI] button.

When you do so, the LEDs above both the [MIDI] button and the [VOICE/UTILITY] button you pressed will begin blinking, and the current setting for the parameter you selected will appear in the display. You can use either the [DATA ENTRY] slider or the [-1] and [+1] buttons to change this setting.

When you've finished making your settings, press the [MIDI] button once again to exit MIDI Utility mode. Most of the functions described previously (i.e., the voice selection, tuning and transpose functions, etc.) will not work while the P-100 is in MIDI Utility mode; therefore, you will have to leave this mode in order to use these functions.



## Transmit and receive channels

This is actually a group of three settings. In addition to the MIDI transmit and receive channels described on page 25, the P-100 lets you specify a separate channel to receive program change messages.

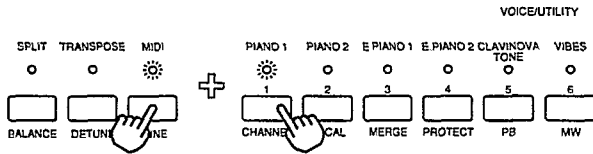

### 1. Enter MIDI Utility mode.

Press the [CHANNEL] button while holding down the [MIDI] button. The current transmit channel setting will appear in the display.

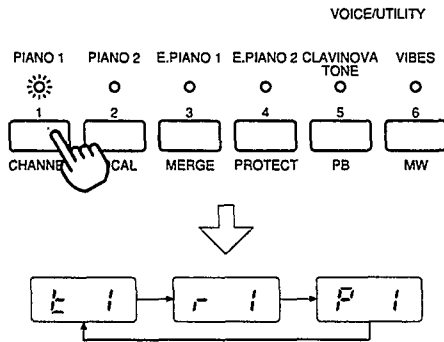

### 2. Select a setting to change.

Press the [CHANNEL] button once or twice more to select the setting you wish to change.

The transmit channel is indicated in the display by the letter “t”, the receive channel by the letter “r”, and the program change receive channel by the letter “p”. If you press the [CHANNEL] button a fourth time, the display will cycle back to the transmit channel setting.

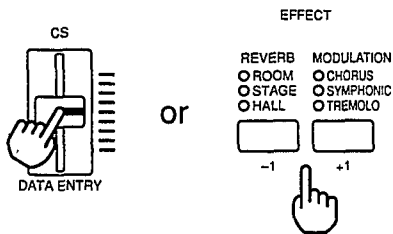

### 3. Set the desired value.

Use the [DATA ENTRY] slider or the [-1] and [+1] buttons to select the desired value.

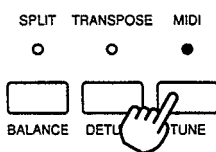
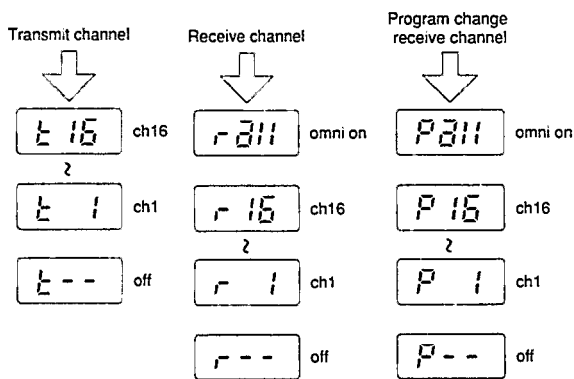

Each of these channel settings can be set to any one of the 16 MIDI channels, or they can be turned off, in which case dashes will be displayed. The two receive channels can also be set to receive messages from all 16 MIDI channels at once, a condition which is known in MIDI parlance as “omni on”. The omni on setting is represented in the P-100’s display by the word “all”.

#### 4. Exit MIDI Utility mode.

Press the [MIDI] button to exit MIDI Utility mode. (If you wish, you can return to step 2 to change other settings before you leave this mode.)



#### Program change receive channel

The P-100 can be set to receive program change messages on a channel other than the normal receive channel. When you select a channel from 1 through 16, or “all”, as the program change receive channel, the P-100 will receive program change messages on the selected channel only. It will not accept program change messages on the receive channel, unless the receive channel and program change receive channel settings happen to coincide.

If you set the program change receive channel to “off”, the P-100 will accept program change messages transmitted on the receive channel. When you use this setting however, the P-100 will ignore any program change receive table settings. (The program change receive table is described on pages 42 and 43.) Instead, program change messages 1 through 10 will select the corresponding P-100 voices, and any program change messages above 10 will be ignored.

The separate program change receive channel setting makes for greater flexibility when using the P-100’s MIDI merge function in an extended MIDI system. This extra flexibility is convenient, but it would be less useful if it meant having to change two receive channels rather than just one all the time.

Fortunately, the P-100 is designed so that whenever you alter the receive channel setting, the program change receive channel will automatically shift to the same value. Thus, when you want to set both to the same value, you need only change one. When setting them to different values, though, be sure to change the receive channel first!

## Local control

This setting allows you to disconnect the P-100's keyboard from its internal tone generator. It is usually turned on so that the P-100 will function normally, producing music in response to the notes you play on the keyboard. When you turn the local control off, the internal tone generator will no longer respond to notes you play. However, the keyboard will still transmit messages via the MIDI OUT terminal, and the tone generator will respond to messages received at the MIDI IN terminal.

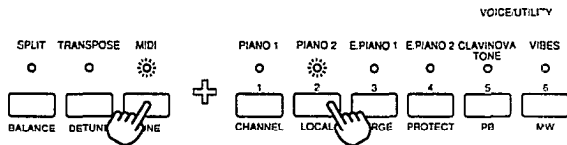

### 1. Enter MIDI Utility mode.

Press the [LOCAL] button while holding down the [MIDI] button. The current local control setting will appear in the display.

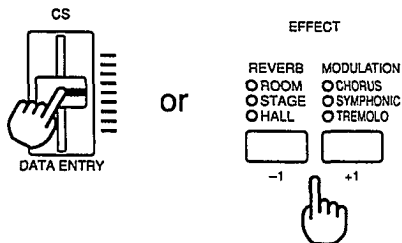

### 2. Set the desired value.

Use the [DATA ENTRY] slider or the [-] and [+1] buttons to switch the setting on or off.

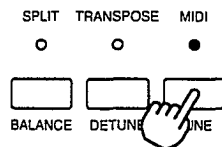
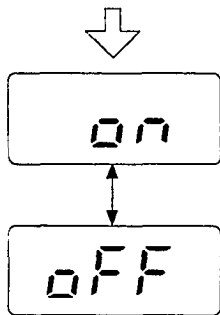

### 3. Exit MIDI Utility mode.

Press the [MIDI] button to exit MIDI Utility mode.

## MIDI merge

When the MIDI merge function is turned on, any MIDI data received at the MIDI IN terminal will be echoed through the MIDI OUT terminal together with data transmitted by the P-100, allowing instruments receiving this data to be controlled by both the P-100 and other devices connected to the P-100's MIDI IN terminal.

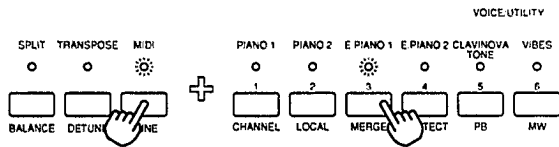

### 1. Enter MIDI Utility mode.

Press the [MERGE] button while holding down the [MIDI] button. The current MIDI merge setting will appear in the display.

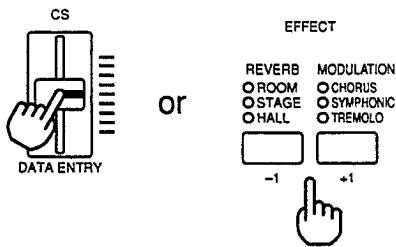

### 2. Set the desired value.

Use the [DATA ENTRY] slider or the [-1] and [+1] buttons to switch the setting on or off.

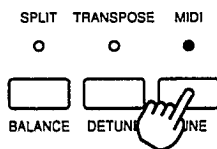
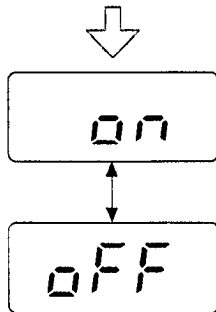

### 3. Exit MIDI Utility mode.

Press the [MIDI] button to exit MIDI Utility mode.

## Bulk protect

The bulk protect function protects the P-100's internal settings against incoming system exclusive messages. When this function is turned on, as is normally the case, the P-100 will not accept any incoming bulk dump or parameter change messages. When it is set to bulk ("bul"), the P-100 will accept parameter change messages, but protect against bulk messages. Finally, when turned off, the P-100 will allow its memory to be overwritten by incoming bulk dumps and system exclusive messages.

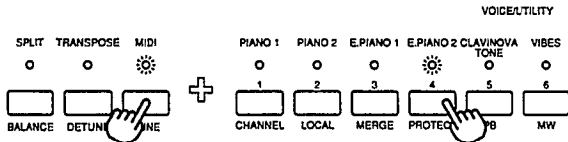

### 1. Enter MIDI Utility mode.

Press the [PROTECT] button while holding down the [MIDI] button. The current bulk protect setting will appear in the display.

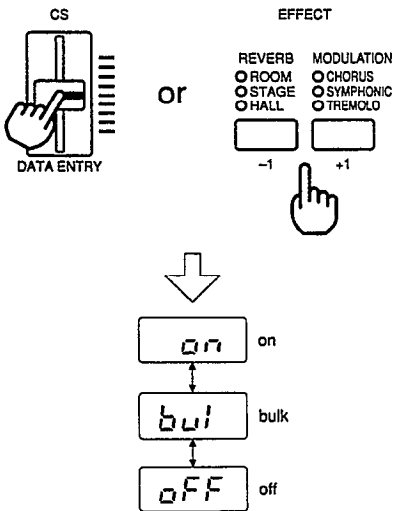

### 2. Set the desired value.

Use the [DATA ENTRY] slider or the [-1] and [+1] buttons to switch the setting to the desired value.

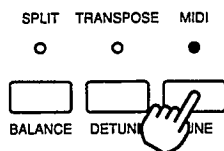

### 3. Exit MIDI Utility mode.

Press the [MIDI] button to exit MIDI Utility mode.

## Pitch bend range

This setting lets you specify how far the pitch of sounds produced by the P-100 will bend when you roll the [PITCH] wheel all the way in either direction. The range you set here applies only to the P-100's internal voices. External tone generators may interpret pitch bend messages from the P-100 in a different manner, depending on their own internal settings.

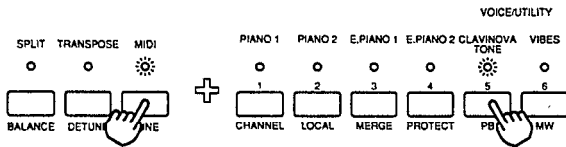

### 1. Enter MIDI Utility mode.

Press the [PB] button while holding down the [MIDI] button. The current pitch bend range setting will appear in the display.

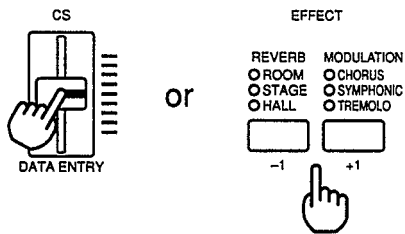

### 2. Set the desired value.

Use the [DATA ENTRY] slider or the [-1] and [+1] buttons to select the desired value.

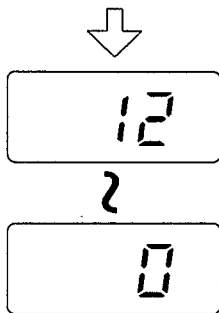

You can set a value from 0 to 12 for the pitch bend range. The number you select is the number of semitones by which the [PITCH] wheel will raise or lower the pitch of a note when it is rolled all the way up or all the way down. Setting a range of 0 will effectively disable the [PITCH] wheel, while a value of 12 will enable the wheel to bend notes up or down an entire octave.

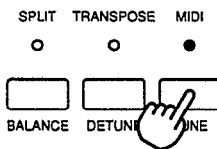

### 3. Exit MIDI Utility mode.

Press the [MIDI] button to exit MIDI Utility mode.

## Modulation wheel

The modulation wheel setting lets you turn off the vibrato produced by the [MODULATION] wheel. The setting you make here applies only to the P-100's internal voices, however. Even when the modulation is turned off, you can still use the P-100's [MODULATION] wheel to send modulation messages to an external tone generator, which will naturally interpret these messages according to its own internal settings.

The modulation wheel setting does not affect the P-100's PIANO 1 and PIANO 2 voices, as the vibrato effect is turned off at all times for these voices.

Please keep in mind that the vibrato effect controlled by the [MODULATION] wheel has nothing to do with the modulation effects which you can select using the [MODULATION] button. The procedures for selecting a modulation effect and setting its depth are described on page 10.

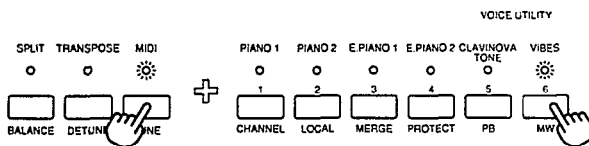

### 1. Enter MIDI Utility mode.

Press the [MW] button while holding down the [MIDI] button. The current modulation range setting will appear in the display.

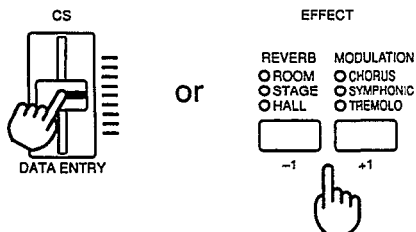

### 2. Set the desired value.

Use the [DATA ENTRY] slider or the [-] and [+] buttons to switch the setting on or off.

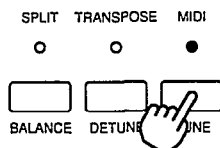
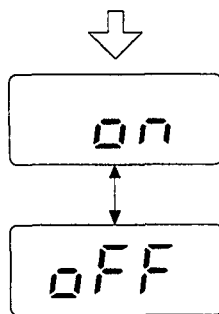

### 3. Exit MIDI Utility mode.

Press the [MIDI] button to exit MIDI Utility mode.

## Assignable controllers

You can assign one of a number of MIDI functions to the P-100's [CS] slider for realtime control during performances. You can use this slider to independently control the volume of the main or sub voices, to transmit aftertouch messages to tone generators capable of receiving them, or to send any of 120 different types of control change messages (with the exception of control changes 0 and 32, which are used for bank select messages).

If you purchase an optional foot controller (Yamaha FC7), you can assign a function to it as well. In addition to the full range of functions mentioned above, the foot controller can be assigned as an overall volume control. You can then use it instead of the [VOLUME] slider, leaving your hands free to do other things. Adding a second realtime controller to your P-100 will thus allow you to increase your P-100's performance flexibility.

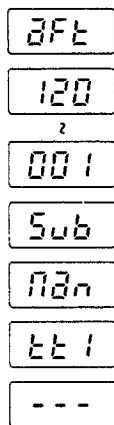
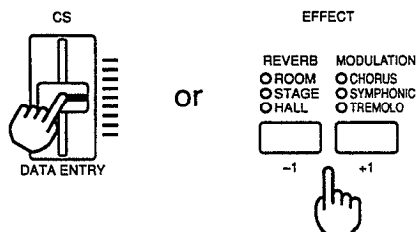
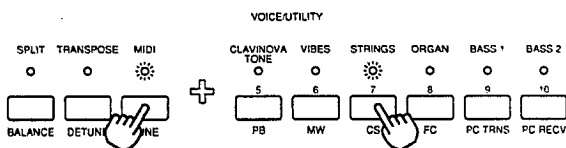

### 1. Enter MIDI Utility mode.

Press the [CS] button while holding down the [MIDI] button. The current [CS] slider function assignment will appear in the display. (To assign a function to the foot controller, press the [FC] button instead of the [CS] button.)

### 2. Select the desired setting.

Use the [DATA ENTRY] slider or the [-1] and [+1] buttons to select the function you wish to assign to the controller. The table below shows the possible assignment values. (Note that overall volume control can only be assigned to the foot controller, and not to the [CS] slider.)

	DISPLAY	FUNCTION
	---	Off (no assignment)
INTERNAL VOLUME	221	P-100 overall volume (FC only)
	n2n	P-100 main voice volume
	Sub	P-100 sub voice volume
MIDI CONTROL CHANGE	001	Control change 001
	:	:
	120	Control change 120
	2Ft	Aftertouch (channel)

The P-100 displays only the control change numbers for control change messages 001 through 120. For the meaning of these numbers, refer to the MIDI Data Format on page 54.

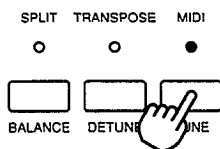

### 3. Exit MIDI Utility mode.

Press the [MIDI] button to exit MIDI Utility mode.



## Program change transmit table

Your P-100 generally transmits a program change message each time you press a [VOICE/UTILITY] button to select a voice. The number of the program change message that is sent is displayed for a second after you press the button, before being replaced by the number of the voice you selected.

When your P-100 left the Yamaha factory, it was preset so that each [VOICE/UTILITY] button will send the program change number corresponding to the number above the button. Thus, an external tone generator connected to the P-100 will receive messages selecting program 1 when you press the [PIANO 1] button, program 2 when you press the [PIANO 2] button, and so on.

These settings are grouped in a table known as the **program change transmit table**. This is merely a table of one-to-one correspondences which assigns a program change number to each of the P-100's ten [VOICE/UTILITY] buttons. You can change the assignments in this table using the procedure described below.

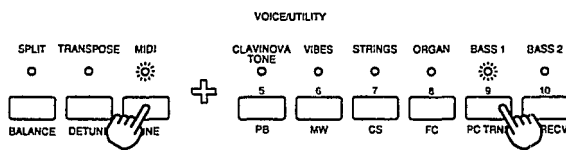

### 1. Enter MIDI Utility mode.

Press the [PC TRNS] button while holding down the [MIDI] button. The LED above the button for the currently selected voice (the main voice in Dual or Split mode) will light steadily, and the current transmit table setting for this button will appear in the display.

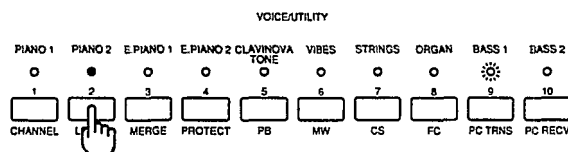

### 2. Select a [VOICE/UTILITY] button.

Press the [VOICE/UTILITY] button for which you wish to change the setting. The current transmit table setting for that button will appear in the display. (If you want to change the transmit table setting for the currently selected button, you can skip to step 3.)

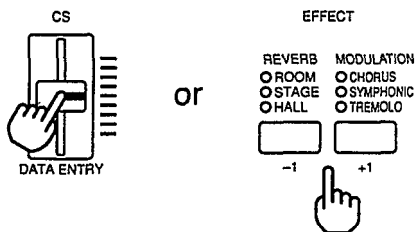

### 3. Set the desired value.

Use the [DATA ENTRY] slider or the [-1] and [+1] buttons to select the desired value.

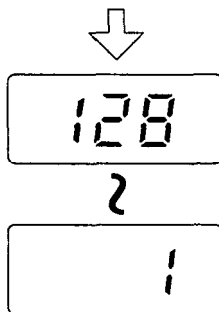

You can set a program change number from 1 to 128 for each of the P-100's [VOICE/UTILITY] buttons. If you wish, you can make this setting using a MIDI message instead of the [DATA ENTRY] slider. To do so, have an external device transmit the desired program change number on the P-100's program change receive channel. The number of the message you send will appear in the P-100's display.

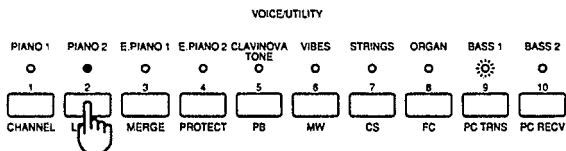

You can also press the selected [VOICE/UTILITY] button to turn the program change transmit function on or off for that button. When you turn the function off, the program change number in the display will be replaced by a row of dashes.

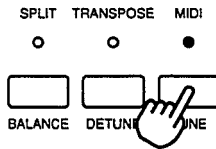
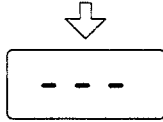

#### 4. Exit MIDI Utility mode.

Press the [MIDI] button to exit MIDI Utility mode. (If you wish, you can return to step 2 to change other settings before you leave this mode.)

Whenever you press a [VOICE/UTILITY] button to select a voice (other than the Dual mode sub voice), the P-100 will check the program change transmit table to determine whether a program change number has been assigned to that button. If so, and if MIDI transmission is enabled, it will transmit the program change number in question from the MIDI out terminal.

When the program change message is transmitted, the program change number which was sent will appear in the LED display briefly each time you press the button to select a voice. However, you will not notice this display unless you change the transmit table settings, since the program change number assigned to each button in the Yamaha factory is the same as the number of the P-100 voice selected by that button.

## Program change receive table

The P-100 is also capable of changing its current voice selection in response to program change messages it receives from external devices. Before it left the Yamaha factory, your P-100 was set so that program change numbers 1 through 10 will select the corresponding voices: program change 1 will select PIANO 1, program change 2 will select PIANO 2, and so on. Program change numbers above 10 were set to have no effect.

These settings are grouped in a table known as the **program change receive table**. This is a table which assigns a P-100 voice selection to each of the 128 program change numbers. The procedure for changing the assignments in this table is described below.

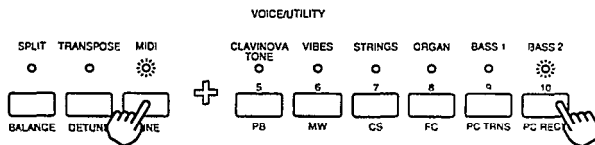

### 1. Enter MIDI Utility mode.

Press the [PC RECV] button while holding down the [MIDI] button. A program change number will appear in the display, and the LED above the [VOICE/UTILITY] button which has been assigned to this program change number will light. (If no button has been assigned to the program change number in question, none of the [VOICE/UTILITY] button LEDs will light.)

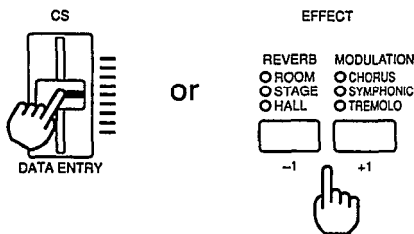

### 2. Select a program change number.

Use the [DATA ENTRY] slider or the [-1] and [+1] buttons to select the desired program change number, or jump to step 3 if you wish to change the setting for the current program change number.

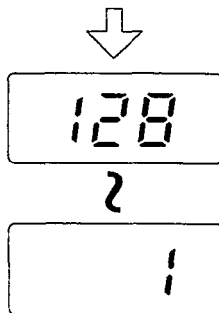

You can select any program change number from 1 to 128. If you wish, you can make your selection using a MIDI message instead of the [DATA ENTRY] slider. To do this, have an external device transmit the desired program change number on the P-100's program change receive channel. The number of the message you send will appear in the P-100's display.

When you select a program change number, the LED above the [VOICE/UTILITY] button for the voice which has been assigned to that number will light. (Again, if no button has been assigned to the program change number in question, none of the [VOICE/UTILITY] button LEDs will light.)

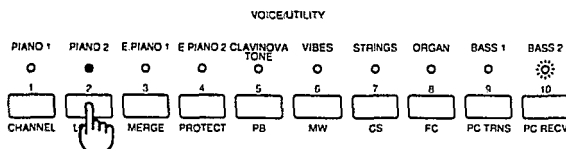

### 3. Select a voice.

Press the [VOICE/UTILITY] button for the voice you wish to assign to the program change number you have selected. The LED above the button you press will light.

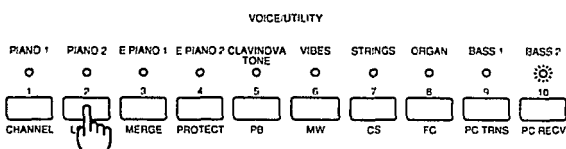

You can also turn the program change receive function off for the selected program change number by pressing the button a second time. When you do so, the LED above the button will go out.

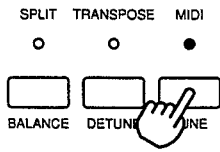

#### 4. Exit MIDI Utility mode.

Press the [MIDI] button to exit MIDI Utility mode. (If you wish, you can return to step 2 to change other settings before you leave this mode.)

Whenever the P-100 receives a program change message, it will check the program change receive table to determine whether a voice has been assigned to the received program change number. If so, the main voice will automatically switch to the voice indicated by the program change receive table. (If the P-100 is in Dual mode, this will cause it to shift to Single mode.) If the program change function has been turned off for that number, the message will simply be ignored.

Keep in mind that the assignments you make in the program change receive table are only valid as long as a channel has been selected as the program change receive channel. The procedure for selecting a program change receive channel is described on pages 32 and 33.

# SPECIAL OPERATIONS

## Bulk dumps

The preceding chapters have shown you how much performance flexibility the P-100 has to offer. But this flexibility comes with a small drawback: to use it effectively, you have to make a large number of settings. If you're like most musicians, you'll find there are certain settings that work best with each song you play. These can include simple voice and mode selections, reverb and modulation effect settings, [PITCH] and [MODULATION] wheel settings, and even program change transmit or receive table assignments.

Of course, changing all of these settings between songs can require a lot of time. While this can be inconvenient for anyone, it is downright frustrating for stage performers who feel acutely the eyes of a waiting audience upon them. To make the transition between songs smooth and easy, you will want to make use of the P-100's bulk dump function,

The bulk dump operation lets you store the contents of the P-100's setup memory in an external device with MIDI data recorder (MDR) capability, like that built into many sequencers, Yamaha's SY99 Music Synthesizer, or our MDF2 MIDI Data Filer. This lets you save an entire bundle of settings, such as those you use when playing a particular song, for fast recall.

To execute a bulk dump, you must first make sure that the MIDI merge function is off. (The procedure for turning the MIDI merge function off is described on page 35.) Also make a note of the P-100's current transmit channel setting, as you will need this information when you attempt to load the data back into the P-100.

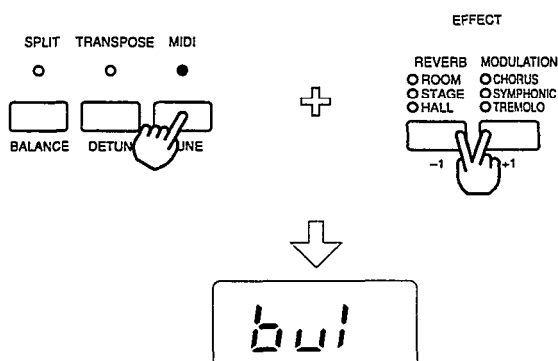

Simultaneously press the [REVERB] and [MODULATION] buttons while holding down the [MIDI] button. The P-100 will automatically send three bulk dumps containing (1) all of the P-100's current settings except for the program change transmit and receive tables, (2) the program change transmit table, and (3) the program change receive table.

The bulk dump will require only about a second, during which the letters "bul" will appear in the display. When it is done, the P-100 will return automatically to the previous mode.



HINT

### Receiving bulk dumps

Dumping the P-100's memory to an external device for storage would not be very useful, of course, if you had no way of loading that data back into the P-100. The reloading of stored data is done by means of a bulk dump executed from the storage device.

To prepare the P-100 to accept a bulk dump, first turn the bulk protect function off using the procedure described on page 36. Also, the P-100 must be set to receive on the channel that was set as the transmit channel when the P-100 dumped the data in question. (This is because the P-100 uses its current transmit and receive channel settings in lieu of a device number when transmitting and receiving bulk dumps.) The procedure for changing the receive channel setting is described on page 32.

Once you have made these preliminary settings, send data to the P-100 using the external device's bulk dump operation. The P-100 will automatically accept the new data.

## Memory initialization

After you've been using the P-100 for a while, you may find yourself wishing that you could erase all your settings and start again with a fresh slate. After all, the P-100 lets you make enough settings that changing the majority of them can be a time-consuming process. Under such circumstances you should use the memory initialization procedure to return the P-100's settings to their initial values, or **factory settings**.

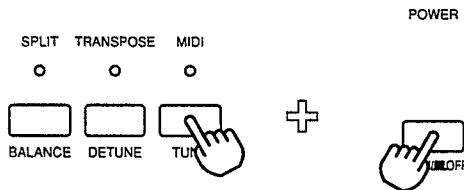

The procedure for initializing the P-100's memory is very simple. Just turn the [POWER] switch off, then turn it on again while holding down the [MIDI] button. This will clear the P-100's RAM and restore it to the condition it was in when you purchased it.

Be sure that you don't need the current settings — or save them using a bulk dump operation, if possible — before you perform this operation. Once you initialize the memory, you will not be able to recall the previous settings.



### P-100 factory settings

The table below lists the P-100's factory settings.

PARAMETERS		FACTORY SETTINGS			
		SINGLE	DUAL	SPLIT	
Mode		Single			
Voice	Main	PIANO 1			
	Sub		STRINGS	BASS 1	
Voice Balance			0	0	
Detune		0			
Split Point		C2			
Main Voice Area in Split Mode		Upper			
Master Tuning		0			
Transpose	Internal	Main	12		
		Sub	12	0	
	MIDI	Main	12		
		Sub			0
Velocity Curve		Internal	Normal		
		MIDI	Normal		
Utility Mode	MIDI Channel	Transmit	1		
		Receive	1		
		Program Change Receive	1		
	Local Control		ON		
	MIDI Merge		OFF		
	Bulk Protect		OFF		
	Pitch Bend Range		2		
	Modulation Wheel		ON		
	CS Assign		007 (volume)		
FC Assign		sub			

Voice Name	Reverb		Modulation	
	Type	Depth	Type	Depth
PIANO 1	STAGE	2	OFF	3*
PIANO 2	ROOM	3	OFF	2*
E.PIANO 1	ROOM	3	SYMPHONIC	3
E.PIANO 2	HALL	3	CHORUS	4
CLAVINOVA TONE	STAGE	5	SYMPHONIC	2
VIBES	STAGE	2	TREMOLO	4
STRINGS	HALL	5	OFF	1*
ORGAN	ROOM	3	TREMOLO	4
BASS 1	ROOM	3	OFF	3*
BASS 2	ROOM	3	CHORUS	2

\* OFF is selected as the modulation type for asterisked voices. If a different modulation type is selected for these voices, however, the indicated modulation depth will be used.

The program change transmit table is set so that the program change number sent by each [VOICE/UTILITY] button matches the number of the voice selected by that button. The program change receive table is set so that program change numbers 1 through 10 select voices 1 through 10, and program change numbers above 10 have no effect.

# SYSTEM APPLICATIONS

---

## Using the P-100 with a tone generator

You can use the P-100's keyboard and MIDI control functions to control tone generators such as Yamaha's TG77. To do so, connect the P-100's MIDI OUT terminal of the P-100 to the MIDI IN terminal of the tone generator as shown below. When two instruments are linked in this manner, the controlling and controlled instruments are referred to as the **master** and **slave** devices, respectively.

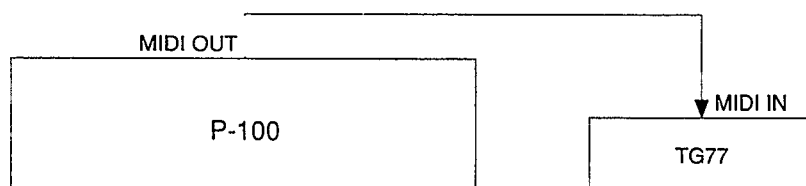

When using the P-100 to control a single voice of a slave tone generator, set the P-100's transmit channel and the slave's receive channel to the same channel number. Any notes you play on the P-100's keyboard in Single or Dual modes will be transmitted to the slave using this channel, together with any messages produced by operation of the [PITCH] and [MODULATION] wheels and the foot pedals. If you assign MIDI control functions to the P-100's [CS] slider and the foot controller, these controls will also send messages on the channel you select.

If your slave is a multitimbral tone generator, as the TG77 is when you switch it to Multi mode, you may want to play two of the voices using the P-100 in Split mode. Assign the receive channel for one of the tone generator's voices to the P-100's transmit channel (Tch), and that for another of its voices to the next higher channel (Tch+1). Thereafter the tone generator will respond to notes you play in the main keyboard area using the first voice, and notes you play in the sub keyboard area using the second voice.

The P-100 will send program change messages on either of these channels each time you press one of the [VOICE/UTILITY] buttons to select a new main or sub voice. The P-100 is thus able to select up to ten of the slave's voices or multiple-voice selections (such as the TG77's multis), depending on your program change transmit table settings. (Note that the way the slave responds to these messages can also depend on its own settings. The TG77, for example, can be set to respond to program change messages in a number of different ways.)

If you need to amplify your tone generator's output, you can do so by connecting its output jacks to the P-100's LINE IN jacks. If you try this, remember that the P-100's reverb, modulation, and equalization effects will not affect the sound output by the tone generator.

---

## Using the P-100 with another MIDI keyboard

Yamaha's SY99 synthesizer incorporates a multitimbral tone generator similar to the TG77. It can therefore be slaved to the P-100 as described above. However, it also has a MIDI keyboard with a broad range of control features and a powerful 16-track sequencer, making it an excellent master device.

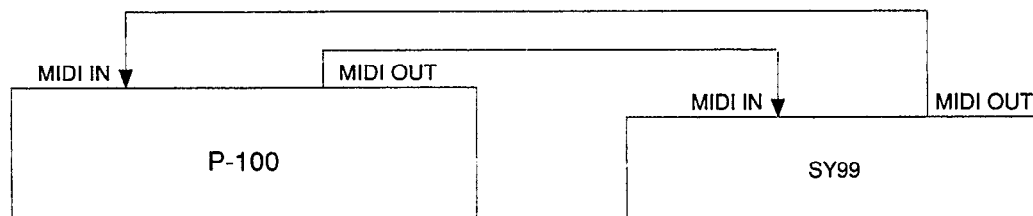

To make full use of the more powerful control capabilities of a MIDI synthesizer like the SY99, you will probably want to connect it to the P-100 with two MIDI cables: one to carry data from the P-100 to the synthesizer, and another to carry it in the other direction. When you connect the P-100 to an external keyboard in this way, either keyboard will be able to control the other device's tone generator, as well as its own.

Set the synthesizer's receive channel (or channels) to match the P-100's transmit channel settings (Tch and Tch+1) as described for the TG77. Then set the P-100's receive channel (Rch) and the synthesizer's keyboard transmit channel to the same number. (You can use the same channel number for Tch and Rch, if you wish, since each of the two MIDI cables actually constitutes a separate MIDI system. Remember to turn the P-100's MIDI merge function off, however, or the P-100 will echo synthesizer's data back to it, causing notes to double up unnecessarily.)

Once you have made these settings, you will be able to control the synthesizer's tone generator from the P-100 as described above. You will also be able to play the P-100 using the synthesizer's keyboard, should that be more convenient. If the keyboard has a built-in sequencer, as the SY99 does, then the sequencer will also be able to control the P-100.

When in Single or Dual mode, the P-100 will respond normally to notes received from the synthesizer. In Split mode, it will play notes received on the receive channel (Rch) with the main voice, and notes received on the next channel up (Rch+1) with the sub voice selection.

If you set the P-100's program receive channel to the channel on which the synthesizer is transmitting, the P-100 will receive program change messages whenever you select one of the synthesizer's voices, and respond to them as specified by your program change receive table settings. This will allow you to control the P-100's voice selection from the synthesizer. It will also make changing your transmit and receive table settings easier, as you will be able to simply select one of the synthesizer's voices instead of using the [DATA ENTRY] slider to set program change number values.



---

## Using the P-100 with an extended MIDI system

Thanks to the great variety of MIDI devices now available, extended MIDI systems come in such a variety of shapes and degrees of complexity that we cannot fully cover all the possibilities here. However, we would like to give you an example of how the P-100's MIDI merge function might be used in a fairly simple extended system consisting of the P-100, a tone generator, and a synthesizer.

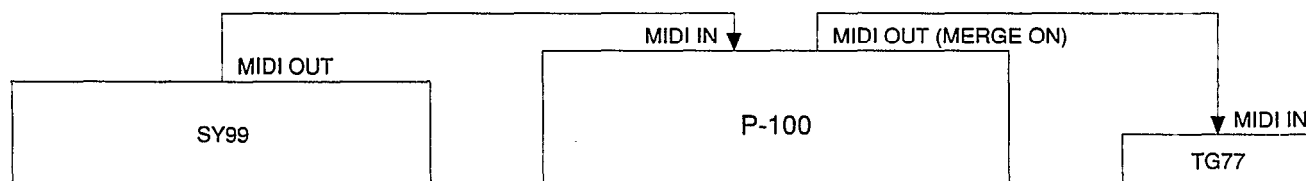

The illustration above shows the SY99, the P-100, and the TG77 hooked up in series, or what is known as a **daisy chain**. This setup constitutes a lot of performance power, as it includes three multitimbral tone generators, two of which — the P-100 and the TG77 — can be controlled by either of the two keyboards, or by the SY99's sequencer.

When the SY99's keyboard or sequencer transmits on the P-100's receive channel, the P-100 will respond as described on the previous page. Since its MIDI merge function is turned on, however, it will also pass messages it receives on all sixteen MIDI channels along to the TG77. The SY99 will thus be able to control both the P-100's two voices and any of the TG77's 16 timbres.

You could achieve the same result by connecting the TG77 to the P-100's MIDI THRU terminal instead of the MIDI OUT. But then, you would not be able to control the TG77 using the P-100's keyboard. That is the charm of MIDI merge function: it allows you to control a single device with either (or both) of two other devices. In the system pictured above, the P-100 will control the TG77 as described previously, letting you play both of these instruments without affecting the SY99. (You might be tempted to connect the TG77's MIDI THRU terminal to the SY99's MIDI IN in order to let the P-100 control the SY99, but you shouldn't. The P-100's MIDI merge function would end up passing data received from the SY99 through the TG77 and back to the SY99, causing all of the notes to double up.)

To sum this system up, then, all three instruments, will respond when you play the SY99, and only two will respond when you play the P-100. By turning off some of the timbres in the SY99 and the TG77, you could come up with a number of variations that will let you play only one of the three instruments at any given time.

---

## Using the P-100 with a MIDI data recorder

If you perform on stage and want to make the most of the P-100's versatility, you will probably find a device with MIDI data recorder (MDR) capability to be a necessity. Such a device will let you store your P-100 setups — including voice selections, DSP effect and MIDI settings, controller assignments, and transmit and receive tables — for fast and easy recall, thus saving you the trouble of changing a host of settings between every song.

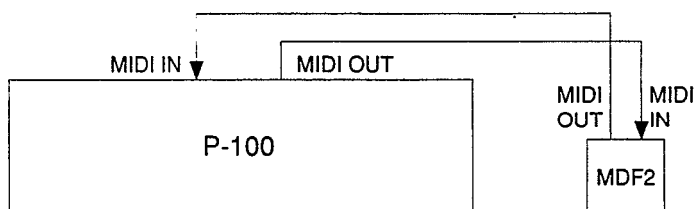

There are many devices, including sequencers, synthesizers such as Yamaha's SY99, and peripheral devices such as the MDF2 MIDI Data Filer, which possess MDR capability. The illustration above shows how you would connect the P-100 to Yamaha's MDF2, a compact, portable data filer suitable for use with the P-100.

With this arrangement, you would use the P-100's bulk dump procedure to send its settings to the MDF2, which would record this data in MDR mode. You could then transmit the data back to the P-100 at any time, as long as the bulk protect function is turned off. Since the MDF2 can store up to 99 different MDR files on a single 3.5" floppy disk, one disk would probably be enough to store your song setups for an entire show.

The MDF2 also has an easy-to-use sequencer function that you could use to record songs you play on the P-100. When playing back songs recorded with this function, you would want to be sure to turn off the P-100's MIDI merge function, to prevent received sequence data from echoing back to the MDF2.

# ERROR MESSAGES

---

Whenever a problem occurs, the P-100 will display an error message to alert you to the nature of the trouble. The meanings of the error messages are described below, together with the action you should take in response to each. (The error messages themselves will be cleared from the display automatically as soon as you operate one of the controls on the P-100's upper panel.)

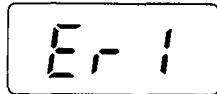
A rectangular box containing the text "Er-1" in a digital font.

## **Backup battery low**

The charge of the internal backup battery is running low. All of your P-100's setup data will be lost if the battery charge runs down completely. Save any settings you may want to keep using the bulk dump procedure, if possible, then contact your Yamaha dealer or a Yamaha service center to have the battery replaced.

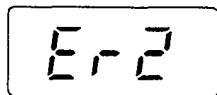
A rectangular box containing the text "Er-2" in a digital font.

## **MIDI buffer full**

The P-100 has received a greater volume of MIDI data than it can process at one time. Take steps to reduce the amount of data the P-100 is receiving.

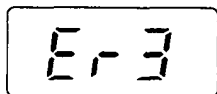
A rectangular box containing the text "Er-3" in a digital font.

## **MIDI data error**

The P-100 had trouble receiving MIDI data. Check your cable connections and try the operation again.

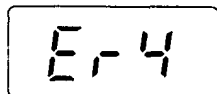
A rectangular box containing the text "Er-4" in a digital font.

## **MIDI checksum error**

The P-100 had trouble receiving a MIDI bulk dump. Check your cable connections and try the operation again.

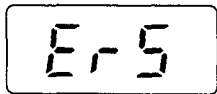
A rectangular box containing the text "Er-5" in a digital font.

## **Bulk protected**

The P-100 could not receive an incoming bulk dump because the bulk protect function has not been turned off. Turn the bulk protect off using the procedure described on page 36, then try the bulk dump operation again.

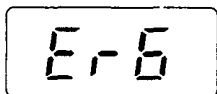
A rectangular box containing the text "Er-6" in a digital font.

## **Device number mismatch**

The P-100 could not receive an incoming bulk dump because the current receive channel (Rch) setting does not match the device number recorded in the bulk data. The bulk data device number is set equal to the P-100's transmit channel (Tch) setting at the time the data is dumped. Set the receive channel to this value using the procedure described on page 33, then try the bulk dump operation again.

# SPECIFICATIONS

---

<b>Keyboard:</b>	88-key (A-1 to C7) Action Effect, velocity sensitive
<b>Tone Generator:</b>	Tone generation method: AWM Voices: PIANO 1, PIANO 2, E.PIANO 1, E.PIANO 2, CLAVINOVA TONE, VIBES, STRINGS, ORGAN, BASS 1, BASS 2 Maximum simultaneous notes: 32/16
<b>Built-in DSP Effects:</b>	Digital reverb: ROOM, STAGE, HALL Modulation: CHORUS, SYMPHONIC, TREMOLO Equalizer: 3-band graphic equalizer
<b>Pitch control range:</b>	Tuning: approx. -50 to +50 cents (increment approx. 0.78 cents) Transposition: -24 to +24 semitones
<b>Controls:</b>	Panel switches: POWER, SPLIT (BALANCE), TRANSPOSE (DETUNE), MIDI (TUNE), VOICE/UTILITY x 10, REVERB (-), MODULATION (+), SPEAKER Sliders: VOLUME, CS (DATA ENTRY), EQUALIZER x 3 (LOW, MIDDLE, HIGH) Wheels: PITCH, MODULATION
<b>Indicators:</b>	Panel display: red three-digit numeric LED Switch lamps: red LED x 19 (SPLIT, TRANSPOSE, MIDI, VOICE/UTILITY x 10, REVERB x 3, MODULATION x 3)
<b>Connectors:</b>	Phone jacks: PHONES (stereo), LINE IN (R, L/MONO), LINE OUT (R, L/MONO), SUSTAIN, SOSTENUTO, SOFT, FOOT CONTROLLER MIDI terminals: IN, OUT, THRU
<b>output:</b>	Amplifiers: 20 watts x 2 Speakers: 13 cm (5") x 2
<b>Dimensions (W x D x H):</b>	1385 x 424 x 157.5 mm (54-1/2" x 16-3/4" x 6-1/4")
<b>Weight:</b>	34 kg (75 lbs.)
<b>Accessories:</b>	FC4 Footswitch, music stand

\* Specifications are subject to change without notice.

# INDEX

---

-1 button 3  
+1 button 3

## A

After-touch, assignable controllers 39, messages 25  
Assignable controllers 39

## B

Balance, assignable controllers 39, Dual mode voices  
13, Split mode voices 16  
Backup battery, error message 50, life 1  
BALANCE button 2  
Bulk, dump 44, protect 36

## C

Channels 25, main voice 27-28, sub voice 28  
Control change, assignable controllers 39, messages  
25  
CS slider 2, assignment 39

## D

DATA ENTRY slider 2  
Demo songs 6  
Detune 14  
DETUNE button 3  
Device number, for bulk dumps 44, error message 50  
Dual mode 12, polyphonic capacity 12, MIDI con-  
figuration 27, selecting voices 12, transposing 23,  
voice balance 13, voice detune 14

## E

Equalizer effect 11  
EQUALIZER sliders 3  
Error messages 50

## F

Factory settings 45  
Foot controller, assignment 39, connection 5  
FOOT CONTROLLER jack 4  
Foot pedals, connection 5, jacks 4

## I

Initialization 45

## K

Keyboard 3, main and sub areas 15, P-100 configura-  
tion 27-28, split point 17, MIDI system applica-  
tions 46-48, tuning 19, velocity curve 20

## L

LED display 2  
LINE IN jacks 4  
LINE OUT jacks 4  
Local control 34

## M

Master, device 46, tuning 19  
Memory, battery backup 1, initialization 45  
Merge, MIDI 25, 35  
Messages 25  
MIDI 25, bulk protect 36, channel settings 32-33, CS  
slider 39, Data Format 54, data recorder 49,  
enabling transmission of channel messages 29, foot  
controller 39, Implementation Chart 58, local con-  
trol 34, MODULATION wheel 38, P-100 configu-  
ration 27-28, pitch bend range 37, system appli-  
cations 46-48, terminals 4,26, transpose 30, Utility  
mode functions 31, velocity curve 29  
MIDI button 2  
MIDI merge 25, during bulk dumps 44, setting 35,  
system applications 48  
MDF2 44, 49  
Modulation, effect setting 10, wheel setting 38  
MODULATION button 3  
MODULATION wheel 2

## O

Omni on 33

## P

Parameter change, bulk protect 36, messages 25  
Pedal jacks 4  
Pitch bend range 37  
PITCH wheel 2  
PHONES jack 4  
Polyphonic capacity 8, in Dual mode 12  
POWER switch 2  
Precautions 1  
Program change, messages 25, receive channel 32-33,  
receive table 42-43, transmit table 40-41

---

Protect, bulk protect setting 36, during dumps 44,  
error message 50

## R

Rear panel 4  
Reception, bulk dumps 44, channels used 27-28,  
program change receive table 42-43, receive chan-  
nel settings 32-33  
Reverb 9  
REVERB button 3

## S

Sequencer 47  
Single mode 7, MIDI configuration 27  
Slave device 46  
SOFT jack 4  
SOSTENUTO jack 4  
SPEAKER switch 4  
Speakers 3  
SPLIT button 2  
Split mode 15, MIDI configuration 28, selecting  
voices 16, transposing 23, voice balance 16  
Split point 17  
SUSTAIN jack 4  
SY99 44, 47-48

## T

Table, program change receive 42-43, program change  
transmit 40-41  
Terminals, MIDI 4, 26  
TG77 46, 48  
Timbres 25  
Transmission, bulk dumps 44, channels used 27-28,  
enabling transmission 29, program change transmit  
table 40-41, transmit channel setting 32-33  
Transpose, main voice 22, MIDI 30, sub voice 23,  
turning function on and off 21  
TRANSPOSE button 2  
Tone generator, P-100 configuration 27-28, system  
applications 46-48  
TUNE button 2  
Tuning 19

## U

Upper panel 2  
Utility mode 31

## V

Vibrato 38  
Voice, balance in Dual mode 13, balance in Split  
mode 16, detune in Dual mode 14, list 7, selection  
in Dual mode 12, selection in Single mode 7,  
selection in Split mode 16  
VOICE/UTILITY buttons 2  
Volume, assignable controllers 39, voice balance in  
Dual mode 13, voice balance in Split mode 16  
VOLUME slider 2

# MIDI DATA FORMAT

## 1. Midi Transmission/Reception Block Diagrams

### 1.1 Reception Flow Diagram

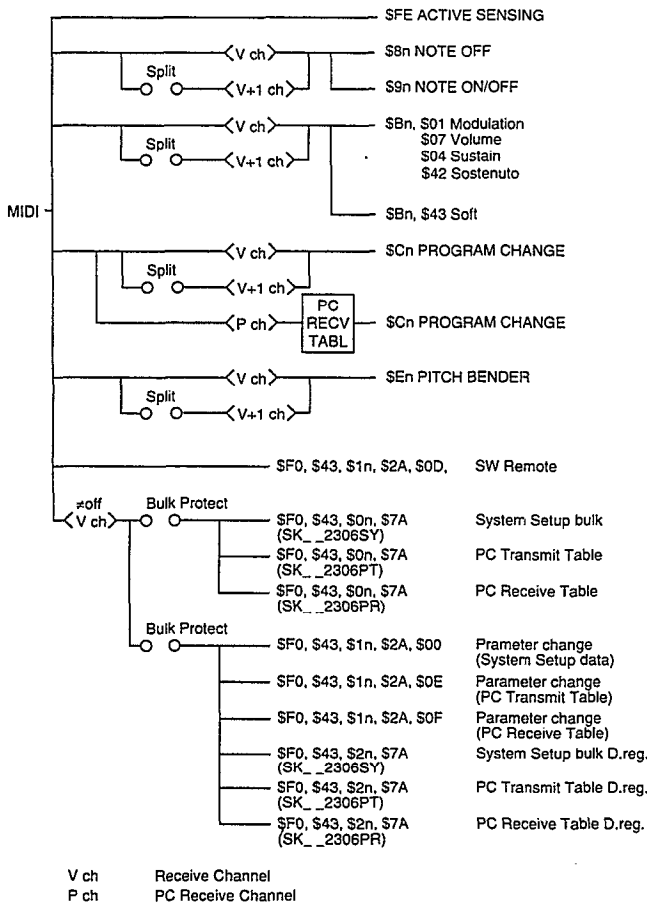

### 1.2 Transmission Flow Diagram

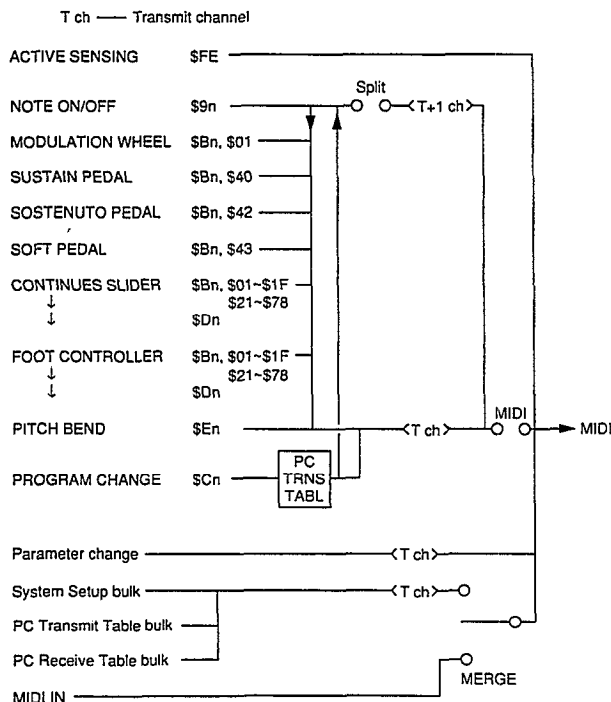

## 2. Channel Messages

### 2.1 Transmission

#### 2.1.1 Note On/Off

Transmitted note range: 21 (A-1)~108 (C7)  
 Velocity range: 0~127 (0 = note off)

The transmitted note number value can be adjusted within the range from 0 (C-2) to 127 (G8) using the MIDI Tch and Tch+1 transpose settings.

#### 2.1.2 CONTROL CHANGE

The P-100's controllers transmit MIDI data as described in the table below.

ctl#	parameter	data rng
1	Modulation wheel	0~127
64	Sustain pedal	0, 127
66	Sostenuto pedal	0, 127
67	Soft pedal	0, 127
1~120	Continuous Slider	0~127
1~120	Foot Controller	0~127

#### 2.1.3 PITCH BEND

Pitch bend messages are transmitted with 7-bit resolution.

#### 2.1.4 AFTERTOUCH

Aftersustain messages are transmitted by the CS slider or the foot controller when these controllers are assigned to the aftersustain function.

#### 2.1.5 PROGRAM CHANGE

Program change messages are transmitted on the transmit channel (Tch) as specified by the program change transmit table when a main voice is selected in any mode. Program change messages are transmitted on the sub voice transmit channel (Tch+1) according to the program change transmit table settings when the Split mode sub voice is selected. No program change message is transmitted when the Dual mode sub voice is selected.

#### 2.1.6 CHANNEL MODE

No channel mode messages are transmitted.

## 2.2 RECEPTION

### 2.2.1 NOTE ON/OFF

Transmitted note range: 0 (C-2)~127 (G8)  
 Velocity range: 1~127

Note numbers below 21 (A-1) are played as the corresponding note of the lowermost octave (A-1 to G#0). Note numbers above 108 (C7) are played as the corresponding note of the uppermost octave (C#6 to C7).

Velocity is received for note on messages only.

### 2.2.2 CONTROL CHANGE

The parameters in the table control are controlled by received control change messages.

ctl#	parameter	data rng
1	Modulation wheel	0~127
7	Volume	0~127
64	Sustain pedal	0, 127
66	Sostenuto pedal	0, 127
67	Soft pedal	0, 127

### 2.2.3 PITCH BEND

Pitch is controlled by the MSB of received pitch bend messages only.

### 2.2.4 AFTERTOUCH

Aftersustain messages are not recognized.

## 2.2.5 PROGRAM CHANGE

Program change messages received on the program change receive channel select a P-100 main voice as specified by the program change receive table. If the P-100 is in Dual mode, the reception of a program change message will cause it to enter Single mode.

Program change messages are received on the receive channel (Rch) only as if the program changes receive channel is off. Under this condition, program change messages 000 through 009 will select voices 1 through 10 as the main voice. If the P-100 is in Dual mode, the reception of a program change message will cause it to enter Single mode.

Program change messages are received on the Split mode sub voice receive channel (Rch+1) only when the P-100 is in Split mode, and only if this channel is not the same as the program change receive channel. If the program change receive channel is the same as the receive channel (Rch), program change messages received on the Rch+1 channel will select a Split mode sub voice as specified by the program change receive table. If the program change receive channel and the receive channel (Rch) are different, program change messages 000 through 009 received on the Rch+1 channel will select voices 1 through 10 as the Split mode sub voice.

The P-100 does not recognize bank select messages.

## 2.2.6 CHANNEL MODE

The P-100 recognizes All Notes Off and Reset All Controllers messages only in omni off mode (i.e., when the receive channel is set to "all").

When the Reset All Controller message is received, the volume is set to maximum, the pitch bend is centered, and all other controllers are set to minimum or turned off.

## 2.3 Configuration of Keyboard and Tone Generator

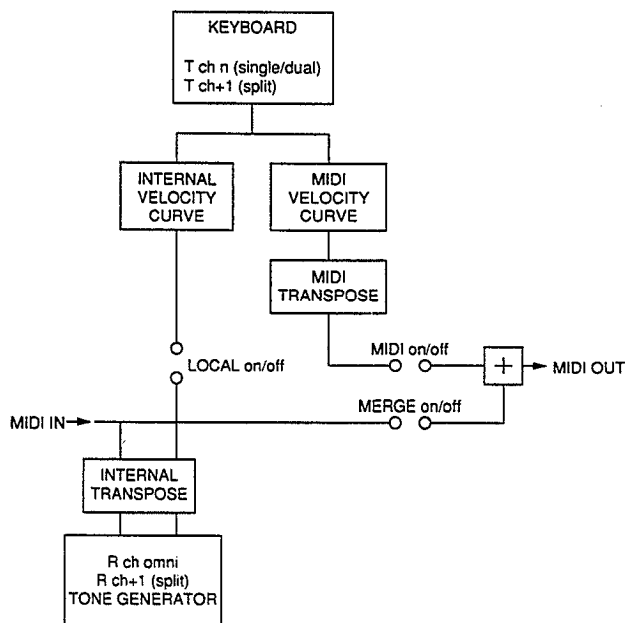

## 2.4 MIDI MERGE FUNCTION

The P-100 possesses a MIDI merge function which allows it to merge the MIDI information it produces with data received at the MIDI IN terminal, then transmit the combined data from the MIDI OUT terminal. This function operates as described below. (In this explanation, the term "merged device" refers to the device which is connected to the P-100's MIDI IN terminal, and whose data is merged with that produced by the P-100.)

MIDI messages received on the channel which has been set as the P-100's MIDI transmit channel (Tch) are transmitted without alteration. As a result, operation of controllers may not produce the expected results when the MIDI merge function is used, since both the P-100's tone generator and any devices receiving the merged data can be controlled by the controllers of either the P-100 or the merged device. As a rule, the last-received control messages will always take priority. Also, notes being sounded by the P-100 may be turned off by received All Notes Off messages.

Although the P-100 is not capable of transmitting its own bank select messages, it will pass on received bank change messages. Any program change messages transmitted by the P-100 will thus apply to the bank selected by received select messages.

The P-100 will never pass on received active sensing messages. Also, if it detects an interruption in active sensing message reception, it will stop transmitting its own active sensing messages from the MIDI OUT terminal for an interval of 500 msec. This may cause devices receiving the merged data to interrupt their processing of note messages transmitted by the P-100.

When system exclusive messages having a length of greater than 32 bytes are received, the relaying of these messages may be cut off by the P-100's own MIDI messages. (The P-100 puts a temporary hold on the transmission of MIDI messages when it receives a system exclusive message. However, as soon as the length of the received system exclusive message exceeds 31 bytes, the hold is cleared. The P-100 then transmits an EOX to end the system exclusive message before transmitting its own data. When this happens, the P-100 will not pass on any received data until it receives data with a status byte indicating a status other than system realtime message.

The P-100's bulk dump function cannot be used while the MIDI merge function is turned on.

## 3. SYSTEM EXCLUSIVE MESSAGES

### 3.1 PARAMETER CHANGE MESSAGES

The P-100 is capable of receiving and transmitting the following four types of parameter change messages:

1. System Setup bulk dump
2. Program change transmit table dump
3. Program change receive table bulk dump
4. Switch Remote parameter change

The P-100 uses its current transmit channel (Tch) setting as its device number when transmitting these parameter change messages, and its current receive channel (Rch) setting when receiving them.

It can therefore transmit or receive these messages only as long as the transmit and receive channels are not turned off.

Switch remote parameter change messages are an exception to this rule, however: they may be received at any time, regardless of the receive channel setting.

#### 3.1.1 SYSTEM SETUP

11110000	f0	
01000011	43	
0001nnnn	nnnn	Device Number
00101010	2A	
00000000	00	
00000000	00	
00000000	00	
0ppppppp	ppppppp	N? (from Table 1.1)
00000000	00	
0vvvvvvv	vvvvvvv	Data Value
11110111	f7	



When a parameter change message indicating the voice mode parameter (VMODE, pppppp=03) is received, the P-100 will enter the specified voice mode. Any other system setup parameter change message will simply change the indicated parameter to the specified value.

### 3.1.2 PROGRAM CHANGE TRANSMIT TABLE

```

11110000 F0
01000011 43
0001nnnn nnnn - Device Number
00101010 2A
00001110 0E
00000000 00
00000000 00
0ppppppp ppppppp - N2 (from Table 1-2)
00000001 i - send switch
0vvvvvvv vvvvvvv - Data Value
11110111 F7

```

Received program change transmit table parameter change messages will change the indicated parameter to the specified value, regardless of the P-100's current mode.

### 3.1.3 PROGRAM CHANGE RECEIVE TABLE

```

11110000 F0
01000011 43
0001nnnn nnnn - Device Number
00101010 2A
00001110 0F
00000000 00
00000000 00
0ppppppp ppppppp - N2 (from Table 1-3)
00000001 00
0vvvvvvv vvvvvvv - Data Value
11110111 F7

```

Received program change receive table parameter change messages will change the indicated parameter to the specified value, regardless of the P-100's current mode.

### 3.1.4 SWITCH REMOTE

```

11110000 F0
01000011 43
0001nnnn nnnn - Device Number
00101010 2A
00001010 0D
00000000 00
00000000 00
0ppppppp ppppppp - N2 (from Table 1-4)
00000000 00
0vvvvvvv vvvvvvv - Data Value
11110111 F7

```

Remote switch parameter change messages are recognized but not transmitted. These messages allow remote control of the functions controlled by the P-100's panel switches, and produce the same results as if the actual switches had been pressed. All switch remote parameter change messages are recognized, regardless of the device number specification.

## 3.2 BULK DUMPS

The P-100 is capable of transmitting and receiving the following three types of bulk dumps:

1. System Setup bulk dumps
2. Program change transmit table dumps
3. Program change receive table bulk dumps

The P-100 will transmit each of these three bulk dumps, in sequence, when the MIDI, REVERB, and MODULATION buttons are pressed simultaneously. It can receive any one of the three bulk dump types independently of the others.

The P-100 uses its current transmit channel (Tch) setting as its device number when transmitting bulk dumps, and its current receive channel (Rch) setting when receiving them.

For the formats of these bulk dumps, refer to Table 2-1 through 2-3 below.

<TABLE 1-1 >

### MIDI PARAMETER CHANGE TABLE (SYSTEM SETUP)

\$F0, \$43, \$1n, \$2A, \$00, \$00, \$00, N2, \$00, V2, \$F7

Notes) n = device number (i.e., transmit/receive table)

N2 = parameter number

V2 = parameter value

	N2	data name	V2 (data range)	note
0	00	MNSFT	-24-24 (o/b)	Main Voice Transpose
1	01	MTUNE	-64-63 (o/b)	Master Tuning
2	02	MVOL	0-127	Master Volume
3	03	VMODE	0-2	Voice mode (0:Single, 1: Dual, 2: Split)
4	04	reserve		
5	05	GRXCH	0-15, off, omni	Program Change Receive Channel
6	06	TXCH	0-15, off	Transmit Channel
7	07	RXCH	0-15, off, omni	Receive Channel
8	08	LOCAL	off/on	Local switch
9	09	MERGE	off/on	Merge switch
10	0A	BLKMPRT	off/bulk/on	Bulk data Memory Protect switch
11	0B	reserve		
12	0C	reserve		
13	0D	BEND	0-12	Pitch Bend Range
14	0E	reserve		
15	0F	reserve		
16	10	MOD	off/on	Modulation Wheel switch
17	11	DETUNE	0-7	Detune
18	12	VOL_MAIN	0-127	Main Voice Volume
19	13	VOL_SUB	0-127	Sub Voice Volume
20	14	BAL_DUAL	-16-15 (o/b)	Balance (Dual)
21	15	BAL_SPLIT	-16-15 (o/b)	Balance (Split)
22	16	V_DUAL	0-9	Sub Voice Number (Dual)
23	17	V_SPLIT	0-9	Sub Voice Number (Split)
24	18	V_MAIN	0-9	Main Voice Number
25	19	SFTSW	off/on	Transpose switch
26	1A	SFTMAINMD	-24-24 (o/b)	Main MIDI Transpose
27	1A	SFTSUBMD	-24-24 (o/b)	Sub MIDI Transpose
28	1B	SFTSUB_D	-24-24 (o/b)	Sub Voice Transpose (Dual)
29	1C	SFTSUB_S	-24-24 (o/b)	Sub Voice Transpose (Split)
30	1D	SPOINT	0-127	Split Point
31	1E	SAREA	lower/upper	Split Main Voice Area
32	1F	TXVELCRV	0-3	MIDI Velocity Curve
33	20	RXVELCRV	0-3	Velocity Curve
34	21	ASINCS	0-127	CS Assign
35	22	ASINFC	0-127	FC Assign
36	23	EFCTSEL1	0-3/0-3	Effect Select for Voice 1
37	24	EFCTSEL2	0-3/0-3	Effect Select for Voice 2
38	25	EFCTSEL3	0-3/0-3	Effect Select for Voice 3
39	26	EFCTSEL4	0-3/0-3	Effect Select for Voice 4
40	27	EFCTSEL5	0-3/0-3	Effect Select for Voice 5
41	28	EFCTSEL6	0-3/0-3	Effect Select for Voice 6
42	29	EFCTSEL7	0-3/0-3	Effect Select for Voice 7
43	2A	EFCTSEL8	0-3/0-3	Effect Select for Voice 8
44	2B	EFCTSEL9	0-3/0-3	Effect Select for Voice 9
45	2C	EFCTSEL10	0-3/0-3	Effect Select for Voice 10
46	2D	EFCTDPT1	0-7/0-7	Effect Depth for Voice 1
47	2E	EFCTDPT2	0-7/0-7	Effect Depth for Voice 2
48	2F	EFCTDPT3	0-7/0-7	Effect Depth for Voice 3
49	30	EFCTDPT4	0-7/0-7	Effect Depth for Voice 4
50	31	EFCTDPT5	0-7/0-7	Effect Depth for Voice 5
51	32	EFCTDPT6	0-7/0-7	Effect Depth for Voice 6
52	33	EFCTDPT7	0-7/0-7	Effect Depth for Voice 7
53	34	EFCTDPT8	0-7/0-7	Effect Depth for Voice 8
54	35	EFCTDPT9	0-7/0-7	Effect Depth for Voice 9
55	36	EFCTDPT10	0-7/0-7	Effect Depth for Voice 10

Note) o/b = offset binary

Note) Parameters with a data range of "off/on" are off when V2 equals 0, or otherwise.

Note) The Effect Select and Depth parameters each consist of two 4-bit nibbles. The lower 3 bits of the MS nibble indicate the modulation setting, while the lower 3 bits of the LS nibble indicate the modulation setting.

Note) Asterisk items are received but not transmitted.

< TABLE 1-2 >

### MIDI PARAMETER CHANGE TABLE (PROGRAM CHANGE TRANSMIT TABLE)

\$F0, \$43, \$1n, \$2A, \$0E, \$00, \$00, N2, V1, V2, \$F7

Notes: n = device number (i.e., transmit/receive table)

N2 = parameter number

V1 = parameter value ( 1 = transmit off)

V2 = parameter value

	N2	data name	V2 (data range)	note
0	00	TXPGM0	0-127	Voice 1
1	01	TXPGM1	0-127	Voice 2
2	02	TXPGM2	0-127	Voice 3
.	.	.	.	.
.	.	.	.	.
8	08	TXPGM8	0-127	Voice 9
9	09	TXPGM9	0-127	Voice 10

<TABLE 1-3 >

MIDI PARAMETER CHANGE TABLE  
(PROGRAM CHANGE RECEIVE TABLE)

\$F0, \$43, \$1n, \$2A, \$0F, \$00, \$00, N2, \$00, V2, \$F7

Notes: n = device number (ie., transmit/receive table)  
N2 = parameter number  
V2 = parameter value

	N2	data name	data range	note
0	00	RXPGM0	0-9, off	program number 0
1	01	RXPGM1	0-9, off	program number 1
2	02	RXPGM2	0-9, off	program number 2
.	.	.	.	.
.	.	.	.	.
126	7E	RXPGM126	0-9, off	program number 126
127	7F	RXPGM127	0-9, off	program number 127

Note: The indicated parameter is considered to be off when any value greater than 9 is received for V2.

<TABLE 1-4>

MIDI PARAMETER CHANGE TABLE (SWITCH REMOTE)

\$F0, \$43, \$1n, \$2A, \$0D, \$00, \$00, N2, \$00, V2, \$F7

Notes: n = device number (i.e., transmit/receive table)  
N2 = parameter number  
V2 = parameter value

	N2	sw. #	note
0	00	PSW 1	SPLIT/BALANCE
1	01	PSW 2	TRANSPOSE/DETUNE
2	02	PSW 3	MIDI/TUNE
3	03	PSW 4	VOICE 1
4	04	PSW 5	VOICE 2
5	05	PSW 6	VOICE 3
6	06	PSW 7	VOICE 4
7	07	PSW 8	VOICE 5
8	08	PSW 9	VOICE 6
9	09	PSW10	VOICE 7
10	0A	PSW11	VOICE 8
11	0B	PSW12	VOICE 9
12	0C	PSW13	VOICE 10
13	0D	PSW14	REVERB
14	0E	PSW15	MODULATION

< TABLE 2-1 >

MIDI BULK DUMP FORMAT

(SYSTEM SETUP)

(DUMP REQUEST)

	data		data
0	\$F0	0	\$F0
1	\$43	1	\$43
2	\$0N	2	\$0N
3	\$7A	3	\$7A
4	[ ] No. of bytes	4	S
5	[ ]	5	K
6	S	6	-
7	K	7	2
8	-	8	3
9	2	9	0
10	3	10	0
11	0	11	6
12	6	12	S
13	0	13	Y
14	S	14	[ ] \$00
15	Y	↓	
16	[ ] \$00	29	
↓		30	\$F7
31			

Items 00-37 from Table 1-1

32	MNSFT
↓	
87	EFCIDPT10
88	check_sum
89	\$F7

<TABLE 2-2 >

MIDI BULK DUMP FORMAT

(PROGRAM CHANGE TRANSMIT TABLE)

(DUMP REQUEST)

	data		data
0	\$F0	0	\$F0
1	\$43	1	\$43
2	\$0N	2	\$0N
3	\$7A	3	\$7A
4	[ ] No. of bytes	4	S
5	[ ]	5	K
6	S	6	-
7	K	7	2
8	-	8	3
9	2	9	0
10	3	10	0
11	0	11	6
12	0	12	P
13	6	13	R
14	P	14	[ ] \$00
15	R	↓	
16	[ ] \$00	29	
↓		30	\$F7
31			

Items 00-09 from Table 1-2

32	TXPGM0 (MSB)
33	TXPGM0 (LSB)
↓	
50	TXPGM9 (MSB)
51	TXPGM9 (LSB)

52	check_sum
53	\$F7

<TABLE 2-3 >

MIDI BULK DUMP FORMAT (SYSTEM SETUP)

(DUMP REQUEST)

	data		data
0	\$F0	0	\$F0
1	\$43	1	\$43
2	\$0N	2	\$0N
3	\$7A	3	\$7A
4	[ ] No. of bytes	4	S
5	[ ]	5	K
6	S	6	-
7	K	7	2
8	-	8	3
9	2	9	0
10	3	10	0
11	0	11	6
12	0	12	P
13	6	13	R
14	P	14	[ ] \$00
15	R	↓	
16	[ ] \$00	29	
↓		30	\$F7
31			

Items 00-7F from Table 1-3

32	RXPGM0
↓	
159	RXPGM127
160	check_sum
161	\$F7

Function ...	Transmitted	Recognized	Remarks
Basic Default	: 1 - 16	: 1 - 16	: memorized
Channel Changed	: 1 - 16	: 1 - 16	:
Default	: 3	: 1, 3	: memorized
Mode Messages	: x	: x	:
Altered	: *****	: x	:
Note	: 0 - 127	: 0 - 127	:
Number : True voice	: *****	: 21 - 108	:
Velocity Note ON	: o 9nH,v=1-127*1:	: o v=1-127	:
Note OFF	: x 9nH,v=0 *1:	: x	:
After Key's	: x	: x	:
Touch Ch's	: o	*2: x	:
Pitch Bender	: o	*1: o 0-12 semi	: 7 bit resolution:
Control	1 : o M.Wheel *1: o		: Modulation
	7 : o Foot volume*1: o		: Volume
	64 : o Sustain *1: o		: Sustain
	66 : o Sostenute *1: o		: Sostenute
Change	67 : o Soft *1: o		: Soft
	1 - 120 : o Assignable *1: x		:
	121 : x	: o	: Reset All Cont.
Prog	: o 0-127 *1: o	: o 0-127	: assignable
Change : True #	: *****	: 0-9	:
System Exclusive	: o	: o	: voice etc.
System : Song Pos	: x	: x	:
: Song Sel	: x	: x	:
Common : Tune	: x	: x	:
System :Clock	: x	: x	:
Real Time :Commands	: x	: x	:
Aux :Local ON/OFF	: x	: x	:
:All Notes OFF	: x	: o (123)	:
:ActiveSense	: o	: o	:
sages:Reset	: x	: x	:
:Notes: Received messages are merged to MIDI OUT when MIDI merge switch:			
: is on.			
: *1,2= Transmit when MIDI switch is on.			
: *2 = Transmit when FC/CS is assigned to AT. (Don't send by keyboard):			

For details of products, please contact your nearest Yamaha or the authorized distributor listed below.

Pour plus de détails sur les produits, veuillez-vous adresser à Yamaha ou au distributeur le plus proche de vous figurant dans la liste suivante.

Die Einzelheiten zu Produkten sind bei Ihrer unten aufgeführten Niederlassung und bei Yamaha Vertragshändlern in den jeweiligen Bestimmungsländern erhältlich.

Para detalles sobre productos, contacte su tienda Yamaha más cercana o el distribuidor autorizado que se lista debajo.

## NORTH AMERICA

### CANADA

**Yamaha Canada Music Ltd.**  
135 Milncr Avcnuc. Scarborough. Ontario. MIS 3R1,  
Canada  
Tel: 416-298-1311

### U.S.A.

**Yamaha Corporation of America**  
6600 Orangthorpc Ave., Buena Park, Calif. 90620.  
U.S.A.  
Tel: 714-522-9011

## MIDDLE & SOUTH AMERICA

### MEXICO

**Yamaha De Mexico S.A. De C.V.,  
Departamento de ventas**  
Javier Rojo Gomez No. 1149. Col. Gpc Del Moral,  
Deleg. Iztapalapa, 09300 Mexico, D.F.  
Tel: 686-00-33

### BRASIL

**Yamaha Musical Do Brasil LTDA.**  
Ave. Reboucas 2636, São Paulo, Brasil  
Tel: 55-11 853-1377

### PANAMA

**Yamaha De Panama S.A.**  
Edificio Interseco, Calle Elvira Mendez no. 10, Piso  
3, Oficina #105, Ciudad de Panama, Panama  
Tel: 507-69-5311

### OTHER LATIN AMERICAN COUNTRIES AND CARIBBEAN COUNTRIES

**Yamaha Music Latin America Corp.**  
6101 Blue Lagoon Drive, Miami, Florida 33126,  
U.S.A.  
Tel: 305-261-4111

## EUROPE

### THE UNITED KINGDOM/IRELAND

**Yamaha-Kemble Musics (U.K.) Ltd.**  
Sherbourne Drive, Tilbrook, Milton Keynes, MK7  
8BL, England  
Tel: 0908-366700

### GERMANY/SWITZERLAND

**Yamaha Europa GmbH.**  
Siemensstraße 22-34, D-2084 Rellingen, F.R. of  
Germany  
Tel: 04101-3030

### AUSTRIA/HUNGARY

**Yamaha Music Austria GmbH.**  
Schleiergasse 20, A-1 100 Wien Austria  
Tel: 0222-60203900

### THE NETHERLANDS

**Yamaha Music Benelux B.V.,  
Verkoop Administratie**  
Kanaalweg 18G, 3526KL, Utrecht, The Netherlands  
Tel: 030-828411

### BELGIUM/LUXEMBOURG

**Yamaha Music Benelux B.V.,  
Brussels-office**  
Keiberg Imperiastraat 8, 1930 Zaventem, Belgium  
Tel: 02-7258220

### FRANCE

**Yamaha Musique France, Division Claviers**  
BP 70-77312 Marne-la-Vallée Cedex 2, France  
Tel: 01-64-61-4000

### ITALY

**Yamaha Musica Italia S.P.A.,  
Home Keyboard Division**  
Viale Italia 88, 20020 Lainate (Milano), Italy  
Tel: 02-937-4081

### SPAIN

**Yamaha-Hazen Electronica Musical, S.A.**  
Jorge Juan 30, 28001, Madrid, Spain  
Tel: 91-577-7270

### PORTUGAL

**Valentim de Carvalho CI SA**  
Estrada de Porto Salvo, Paco de Arcos 2780 Oeiras,  
Portugal  
Tel: 01-443-3398/4030/1823

### GREECE

**Philippe Nakas S.A.**  
Navarinou Street 13. P. Code 10680, Athens, Greece  
Tel: 01-364-7111

### SWEDEN

**Yamaha Scandinavia AB**  
J.A. Wettergrens gata 1. Box 30053, 400 43  
Göteborg, Sweden  
Tel: 031-496090

### DENMARK

**Yamaha Scandinavia Filial Denmark**  
Finsensvej 86, DK-2000 Frederiksberg, Denmark  
Tel: 31-87 30 88

### FINLAND

**Fazer Music Inc.**  
Länsituulentie 1A, SF-02100 Espoo, Finland  
Tel: 90-435 011

### NORWAY

**Narud Yamaha AS**  
Østerdalen 29, 1345 Østeras  
Tel: 02-24 47 90

### ICELAND

**Páll H. Pálsson**  
P.O. Box 85, Reykjavik, Iceland  
Tel: 01-19440

### EAST EUROPEAN COUNTRIES (Except HUNGARY)

**Yamaha Europa GmbH.**  
Siemensstraße 22-34, D-2084 Rellingen, F.R. of  
Germany  
Tel: 04101-3030

## AFRICA

**Yamaha Corporation,  
International Marketing Division**  
Nakazawa-cho 10-1, Hamamatsu, Japan 430  
Tel: 053-460-2311

## MIDDLE EAST ASIA

### ISRAEL

**R.B.X. International Co., Ltd.**  
P.O. Box 11136, Tel-Aviv 61111, Israel  
Tel: 3-298-251

### TURKEY/CYPRUS

**Yamaha Musique France, Division Export**  
BP70-77312 Marne-la-Vallée Cedex 2, France  
Tel: 01-64-61-4000

## OTHER COUNTRIES

**Yamaha Corporation,  
International Marketing Division**  
Nakazawa-cho 10-1, Hamamatsu, Japan 430  
Tel: 053-460-2311

## ASIA

### HONG KONG

**Tom Lee Music Co., Ltd.**  
15/F, World Shipping Centre, Harbour City, 7  
Canton Road, Kowloon, Hong Kong  
Tel: 3-722-1098

### INDONESIA

**PT. Yamaha Music Indonesia (Distributor)  
PT. Nusantik**  
Gedung Yamaha Music Center, Jalan Jend. Gatot  
Subroto Kav. 4, Jakarta 12930, Indonesia  
Tel: 21-520-2577

### MALAYSIA

**Yamaha Music Malaysia, Sdn., Bhd.**  
16-28, Jalan SS 2/72, Petaling Jaya Sclangor,  
Malaysia  
Tel: 3-717-8977

### PHILIPPINES

**Yupangco Music Corporation**  
339 Gil J. Puyat Avenue, Makati, Metro Manila  
1200, Philippines  
Tel: 2-85-7070

### SINGAPORE

**Yamaha Music Asia Pte., Ltd.**  
80 Tannery Lane, Singapore 1334. Singapore  
Tel: 747-4374

### TAIWAN

**Kung Hsue She Trading Co., Ltd.**  
KHS Fu Hsing Building, 322, Section 1, Fu-Hsing  
S Road, Taipei 10640, Taiwan, R.O.C.  
Tel: 20-709-1266

### THAILAND

**Siam Music Yamaha Co., Ltd.**  
933/1-7 Rama I Road, Patumwan, Bangkok,  
Thailand  
Tel: 2-215-0030

### THE PEOPLE'S REPUBLIC OF CHINA AND OTHER ASIAN COUNTRIES

**Yamaha Corporation,  
International Marketing Division**  
Nakazawa-cho 10-1, Hamamatsu, Japan 430  
Tel: 053-460-2311

## OCEANIA

### AUSTRALIA

**Yamaha Music Australia Pty. Ltd.**  
17-33 Market Street, South Melbourne, Vic. 3205,  
Australia  
Tel: 3-699-2388

### NEW ZEALAND

**Music Houses of N.Z. Ltd.**  
146/148 Captain Springs Road, Te Papapa,  
Auckland, New Zealand  
Tel: 9-640-099

### COUNTRIES AND TRUST TERRITORIES IN PACIFIC OCEAN

**Yamaha Corporation,  
International Marketing Division**  
Nakazawa-cho 10-1, Hamamatsu, Japan 430  
Tel: 053-460-2311

**HEAD OFFICE** Yamaha Corporation, Electronic Musical Instrument Division  
Nakazawa-cho 10-1, Hamamatsu, Japan 430  
Tel: 053-460-2445

## SERVICE

This product is supported by YAMAHA's worldwide network of factory trained and qualified dealer service personnel. In the event of a problem, contact your nearest YAMAHA dealer.

**YAMAHA**