

YAMAHA

**POWER SUPPLY
ALIMENTATION
NETZMODUL**

PW2000M

OPERATING MANUAL
MANUEL D'UTILISATION
BEDIENUNGSANLEITUNG

IMPORTANT NOTICE FOR THE UNITED KINGDOM

Connecting the Plug and Cord

WARNING: THIS APPARATUS MUST BE EARTHED

IMPORTANT: The wires in this mains lead are coloured in accordance with the following code:

GREEN-AND-YELLOW	:	EARTH
BLUE	:	NEUTRAL
BROWN	:	LIVE

As the colours of the wires in the mains lead of this apparatus may not correspond with the coloured markings identifying the terminals in your plug proceed as follows:

The wire which is coloured GREEN-AND-YELLOW must be connected to the terminal in the plug which is marked by the letter E or by the safety earth symbol or coloured GREEN or GREEN-AND-YELLOW.

The wire which is coloured BLUE must be connected to the terminal which is marked with the letter N or coloured BLACK.

The wire which is coloured BROWN must be connected to the terminal which is marked with the letter L or coloured RED.

English

The PW2000M is a rack-mountable power supply designed to provide power for the M2000 series of mixers. Since it is specifically designed for use with these mixers, **do not** attempt to use it to supply power to any other equipment, or use any other power supply with your M2000 mixer. There are three models of the PW2000M power supply — a 100VAC model for use in Japan, a 120VAC model for use in the USA and Canada, and a 230VAC model for use elsewhere in the world.

ENSURE YOU ARE USING THE CORRECT MODEL FOR YOUR LOCAL POWER SUPPLY *BEFORE* CONNECTING THE POWER!

Front panel

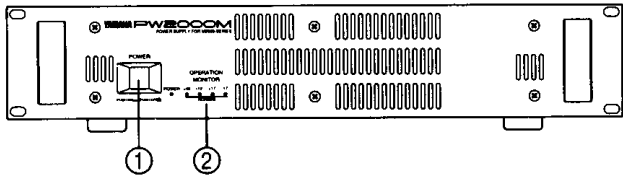

Rear panel

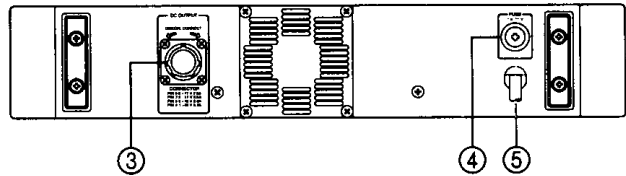

Front and rear panel

① Power switch (POWER)

When this switch is depressed, AC power is supplied to the PW2000M, and the correct DC voltages are supplied to the M2000 console via the umbilical cable. The LED next to the switch indicates when the power is on.

② Operating monitor (OPERATION MONITOR)

There are 4 green LED indicators to monitor the power supplied to the M2000 mixing console (+48, +12, +17, and -17V). In normal operation, these LEDs should all be lit. If one or all are off, it means that there is a fault in the power being supplied to your M2000. Contact your Yamaha service center if this happens.

③ Umbilical connector (DC OUTPUT)

This locking multi-pin female connector supplies regulated power to the M2000 from the PW2000M. To lock the connector into place, push and turn clockwise. Reverse to unlock and remove the connector.

CAUTION: Always make sure that the power to the PW2000M is turned off before connecting or disconnecting this connector to or from either the console or the PW2000M.

④ Main Fuse (FUSE)

This is the primary fuse of the PW2000M power supply. If it is blown replace it **only** with a fuse of the same current rating and type (6A 250V slow-blow for Japanese, USA and Canadian model, T3.15A 250V slow-blow for the 230V General model).

⑤ Power cable

Used to connect the PW2000M to the AC mains.

PW2000M umbilical connector pin assignments

Pin	Function
1	E (+48V)
2	E (+12V)
3	E (\pm 17V)
4	+48V
5	+12V
6	+17V
7	-17V
8	GND
9	DETECT A
10	DETECT B

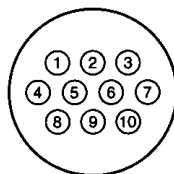

General specifications

Dimensions (w × d × h)

480 × 334.5 × 98 mm (18-7/8" × 13-3/16" × 3-1/2")

Weight

13kg (28.5 lb)

Secondary

±17V 2.5A

+12V 3.8A

+48V 0.3A

Power requirements

USA and Canadian models: 120VAC, 60Hz

British model: 240V, 50Hz

General model: 230VAC, 50Hz

Mounting

Shelf mounting

The PW2000M can be used on any flat level surface as long as there is adequate ventilation. Do not remove the feet as this will block airflow through the bottom panel.

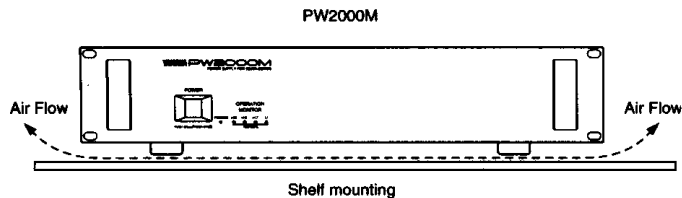

Rack mounting

IMPORTANT! If unit(s) are to be used in a rack mounting situation, it is recommended that they should be used with ventilation panels as illustrated.

Yamaha VP1 Ventilation Panel may be provided as an optional accessory (open area should be at least 35% of total area).

– Permanent-installation racks

The PW2000M can be mounted in any standard 19" electronic equipment rack. The rear panel of the rack should be left open to promote smooth airflow. Refer to the illustration below for ideal cooling configuration.

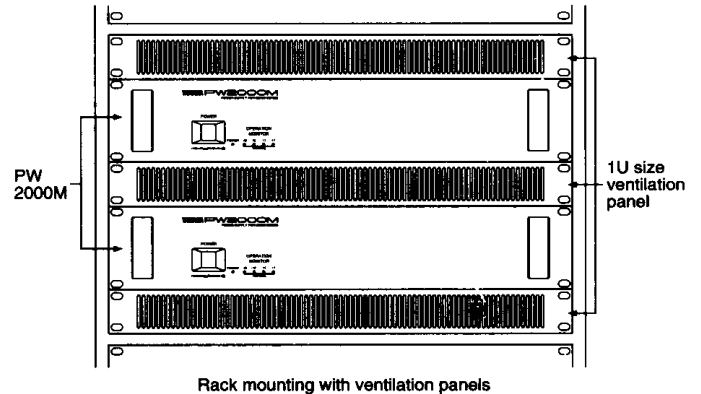

– Portable racks

In portable racks and roadcases, adequate ventilation is vital. Do not operate the PW2000M while it is installed in a 2U rack, as this will not provide enough ventilation.

If installed in a 3U rack you must install a 1U ventilation panel above the unit, and cut ventilation holes in the top AND bottom of the rack above and below the heatsinks on the unit, as shown below.

If installed in a 4-or-more U rack, ventilation panels positioned above and below the unit will allow adequate ventilation. A 1U extractor fan can be installed instead of one of the ventilation panels, for maximum airflow.

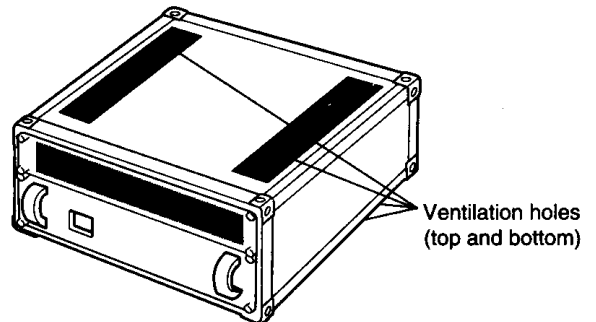

Dimensions/Abmessungen

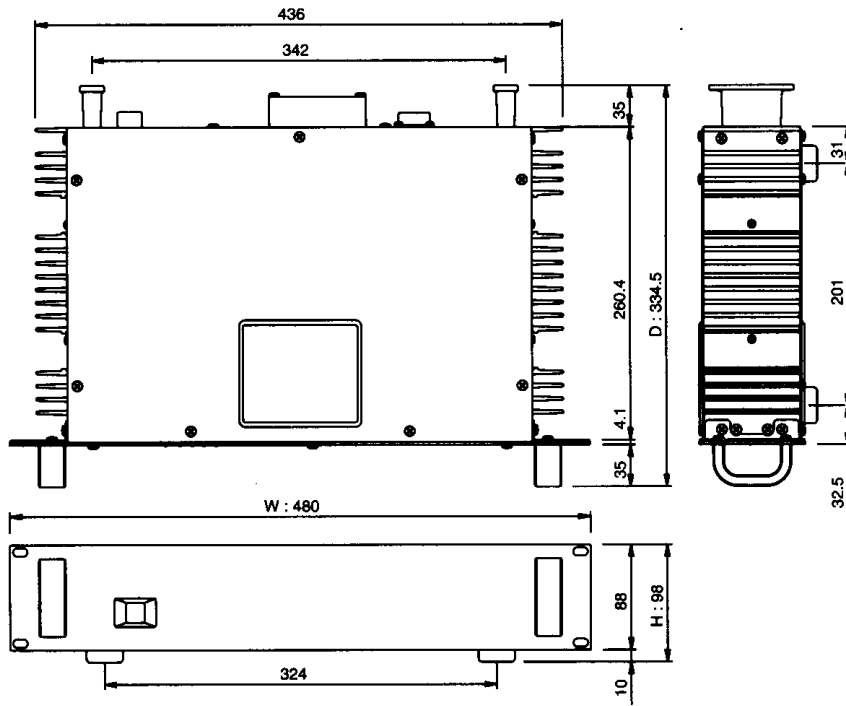

YAMAHA

VR65870 R2 1 CR

96 08 200 CR Printed in Japan

YAMAHA CORPORATION
P.O.Box 1, Hamamatsu, Japan