

YAMAHA

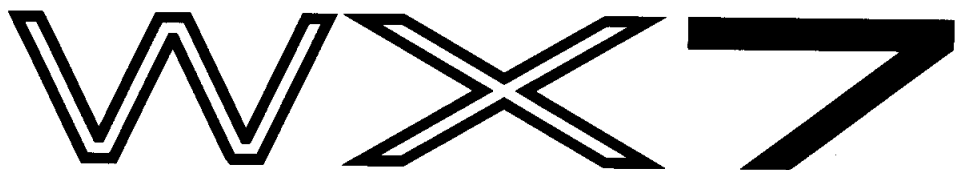

WIND MIDI CONTROLLER
CONTROLEUR MIDI A VENT
WIND MIDI CONTROLLER

OWNER'S MANUAL
MANUEL D'UTILISATION
BEDIENUNGSANLEITUNG

INTRODUCTION

Congratulations and thank you for purchasing the Yamaha WX7 Wind MIDI Controller.

Since 1887, Yamaha has been producing quality musical instruments, both acoustic and electronic. Now in its 100th year, Yamaha is proud to present an extraordinarily expressive and technically sophisticated MIDI musical instrument, the WX7 Wind MIDI Processor. The WX7 combines Yamaha state-of-the-art technology with its traditional craftsmanship to bring the professional saxophone player into the expressive world of electronic music.

With its light, sleek design and its advanced features, the WX7 is destined to be one of the most used and influential MIDI controllers for many years to come. MIDI (Musical Instrument Digital Interface) is a computer "language" adapted for music, to allow electronic instruments to "talk" to each other. Through the power of MIDI, the WX7 can play synthesizers and tone generators, enter music directly onto computers and sequencers for noise-free multitrack recording, change programmed settings on MIDI-compatible equalizers, digital delay devices, and reverb units, and perform a host of other modern musical feats.

Yet, the WX7 is extremely easy to operate, even for the saxophone player with a limited experience of electronic

music devices. It uses the standard Böhm fingering and, in normal operation, can be played in two octaves. A special Octave Transpose key lets you extend the total range of the instrument to over 7 octaves. The WX7 allows you to bend pitch by lip pressure as well as by a conveniently located Pitch Bend Wheel. And you can control the volume, vibrato, and tone of the connected MIDI sound source by the way you blow (breath pressure).

The WX7's Key Hold and Dual Play capabilities are highly impressive and useful features. With Key Hold, you can hold a selected note while playing other notes. The held note can remain at one pitch, or follow the melody at a selected interval. The Dual Play feature improves upon the Key Hold by sending the lead line and held note on independent MIDI channels, giving your playing an unprecedented fullness by letting you play two separate MIDI devices, producing two different digital instrument sounds.

The more your expertise at the use of MIDI grows (in particular, the more you become familiar with the use of the MIDI devices that you will control with your WX7), the more powerful and versatile the WX7 becomes. Its possibilities are endless!

CONTENTS

HOW TO USE THIS MANUAL	2	ADJUSTING THE PLAYING	
PRECAUTIONS	3	RESPONSE	13
GUIDE TO THE CONTROLS	3	MIDI AND APPLICATIONS	15
ACCESSORIES AND MAINTENANCE	5	GLOSSARY	17
QUICK GUIDE	7	SPECIFICATIONS	19
SETTING UP	8	MIDI DATA FORMAT	20
PLAYING THE WX7	9	FCC INFORMATION	20
THE DIP SWITCHES	11	MIDI IMPLEMENTATION	21
		FINGERING CHARTS (the last page of this manual)	

HOW TO USE THIS MANUAL

We recommend that you read this manual carefully in order to get the most out of your WX7.

- Read the **PRECAUTIONS** (p.3) first, to familiarize yourself with ways in which the WX7 can be damaged or misused. A thorough knowledge of this section will enable you to get the optimum performance out of your WX7 for many years to come.
- The **GUIDE TO THE CONTROLS** (p.3) section gives a clear, easy-to-follow introduction to the controls built into the WX7. Although sophisticated, the WX7's controls are laid out in a neat, orderly manner allowing you to make full use of its features with a minimum of effort.
- The **ACCESSORIES AND MAINTENANCE** (p.5) section describes the complete range of accessories supplied with the WX7, and gives tips on how to keep the WX7 in perfect working order, for years of trouble-free playing.
- The **QUICK GUIDE** (p.7) gives you an opportunity to start playing the WX7, without having to read the rest of the manual. It gives a very brief and concise guide to connecting and playing the WX7. You should then go on to succeeding sections of the manual, for full explanations on the use of the WX7.
- **SETTING UP** (p.8), as the title indicates, describes the simple connection procedure of the WX7 plus its MIDI/Power pack. Once you understand this procedure, you'll be able to set up your WX7 and be ready to play in minutes.
- **PLAYING THE WX7** (p.9) gets you right into playing, and in a remarkably concise and easy-to-understand section, tells you all you need to know about its performance features.
- **THE DIP SWITCHES** (p.11) details the setting of the concealed switches on the WX7, which are used to select a variety of impressive functions.
- **ADJUSTING THE PLAYING RESPONSE** (p.13) tells you how to alter the WX7's response to both lip pressure and breath pressure, so you can "customize" the WX7 to suit your individual playing style.

- A special section on **MIDI AND APPLICATIONS** (p.15) is provided as a simplified crash course in MIDI technology. This will give you a brief introduction to MIDI plus some system examples, to suggest just a few of the virtually unlimited number of ways to use the WX7 with a MIDI digital music system. For further reference on MIDI, consult the manual of your MIDI synthesizer or tone generator, as well as the variety of publications and magazines now available on the subject of this fast-growing technology.
- A **GLOSSARY** (p.17) has been included, which clearly explains the terminology used in this manual, particularly for the benefit of the WX7 owner with a limited knowledge of digital music and MIDI.
- Following the technical **SPECIFICATIONS** (p.19), the **MIDI IMPLEMENTATION** (p.23) section gives full details of the MIDI technology used in the WX7, for users seriously interested in MIDI and computer applications of this advanced unit.
- The all-important **FINGERING CHARTS** (the last page of this manual) indicates in musical score form the available fingerings on the WX7. All the standard fingering positions are provided, plus additional fingering positions for fast, easy octave transposing.

PRECAUTIONS

- Avoid placing your WX7 in direct sunlight or close to a source of heat. Also, avoid locations where the instrument is likely to be subjected to vibration, excessive dust, cold or moisture. All of these conditions could have a detrimental effect on both the mechanisms and the circuitry incorporated into the WX7.
- Avoid applying excessive force to the switches and keys. Use the mouthpiece and keys with as much care as you would with any other top quality wind instrument. Also avoid dropping the instrument or otherwise subjecting it to impact. While the internal circuitry is of reliable integrated circuit design, the WX7 should be treated with care.
- When not in use, even for short periods of time, always keep the WX7 in the supplied carrying case.
- When unplugging cords (MIDI, audio, power, etc.) from the WX7, never unplug by pulling on the cords; this can result in damage to the WX7 or the cords.
- All computer circuitry, including that of the WX7, is sensitive to power surges or voltage spikes, such as those caused by lightning. For this reason, the MIDI/Power Pack of the WX7 should be turned off and unplugged from the wall socket (if using it with AC power rather than the internal batteries) in the event of an electrical storm.
- Computer circuitry is also sensitive to electromagnetic radiation, such as is generated by television sets. Use your WX7 at a suitable distance from such equipment to avoid malfunctions in the WX7 or any other connected equipment.
- When making connections, carefully follow the instructions detailed in the SETTING UP section (both in the WX7 manual and that of the MIDI device which it is controlling) so as to avoid damage to any of your equipment.
- When cleaning the WX7, use a slightly damp cloth, with a mild detergent if necessary, and dry with the soft cloth provided. Never use solvents (such as benzine or thinner) since they can melt or discolor the finish. Also, never use aerosol sprays near the WX7 as they can get into the circuitry and prevent accurate transmission of data.
- Your WX7 and the MIDI/Power Pack contain no user serviceable parts. Opening them or tampering with them can lead to electrical shock as well as damage. Refer all servicing to qualified Yamaha personnel.

GUIDE TO THE CONTROLS

Front View/Rear View

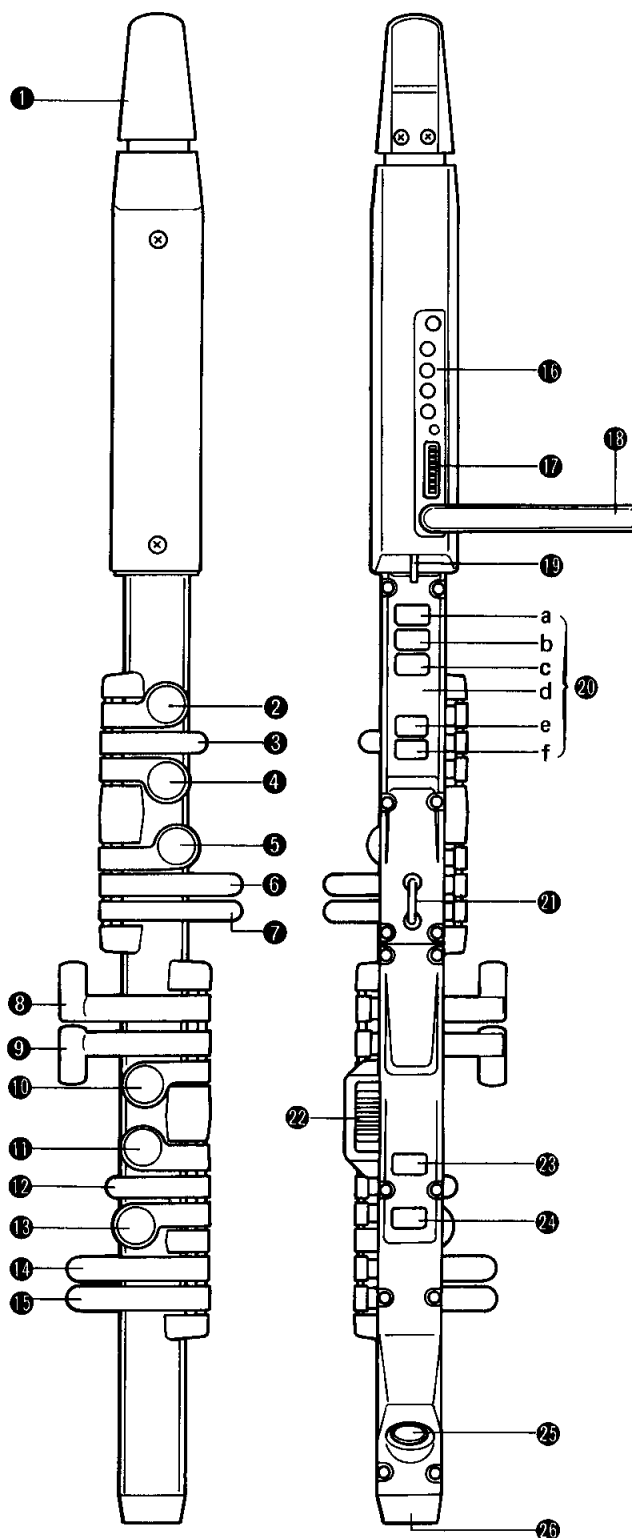

(Front View)

(Rear View)

- ① Mouthpiece (detachable).
- ② B key
- ③ A[♯] key
- ④ A key
- ⑤ G key
- ⑥ G[♯] key
- ⑦ Low B key
- ⑧ Whole tone up key
- ⑨ Semitone up key
- ⑩ F key
- ⑪ E key
- ⑫ F[♯] key
- ⑬ D key
- ⑭ D[♯] key
- ⑮ C key
- ⑯ Lip/Wind controls (four rotary pots, under cover).
Refer to the ADJUSTING THE PLAYING RESPONSE section for details.
- ⑰ DIP switches (eight, under cover).
Refer to THE DIP SWITCHES section for details.
- ⑱ Lip and Wind Sensors/Dip Switches Cover
A soft rubber cover protects the adjustment controls and switches from damage or accidental changes. To get at the controls, pull the top part of the cover away from the instrument, but do not take it completely off. A small knob at the bottom allows you to pivot the cover and use the controls, yet still keeps it safely attached to the WX7.
- ⑲ WX7/Power Pack ring
Connect this ring to the hook on the MIDI/Power Pack to keep it and the WX7 together when not playing.

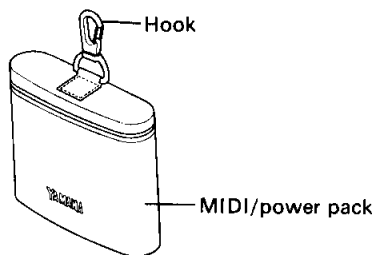

- ⑳ Octave Transpose keys.
Normally played with the left thumb, these keys allow transposition of the played note, in the following order (reading from top to bottom): three octaves up (a); two octaves up (b); one octave up (c); a zero notch (d) in which to rest the thumb for playing in concert pitch; one octave down (e); two octaves down (f).

- ㉑ Playing strap ring
Attach the playing strap to this ring to hang the WX7 from your body while playing.
- ㉒ Pitch Bend Wheel.
Operated by the right thumb, this allows you to bend the pitch of notes, by an amount corresponding to the pitch bend range setting on the connected MIDI sound source.
- ㉓ Hold Key.
Allows one note to be held while other notes are played. Refer to the PLAYING THE WX7 section for details.
- ㉔ Program Change key.
Permits selection of programs (on the connected MIDI sound source) from the WX7. To change programs, hold down the Program Change key and press an Octave Transpose key. The top Octave Transpose key (a) corresponds to program number 1 on your tone generator, the next Octave Transpose key (b) corresponds to program 2, and so on down to the bottom Octave Transpose key (f), which corresponds to program 5.
- ㉕ MIDI/DC connector.
For connection of the WX7 to its MIDI/Power Pack. This connector has two functions: to supply DC power to the WX7, and to transmit MIDI data from the WX7.
- ㉖ Drain Hole.
For drainage of condensation from the WX7.

ACCESSORIES AND MAINTENANCE

The WX7 comes fully equipped with everything you need to connect it to your MIDI synthesizer or tone generator and begin playing. This section lists all the supplied accessories, explains their usage, and gives tips on how to maintain your WX7, for years of trouble-free use.

MIDI/POWER PACK

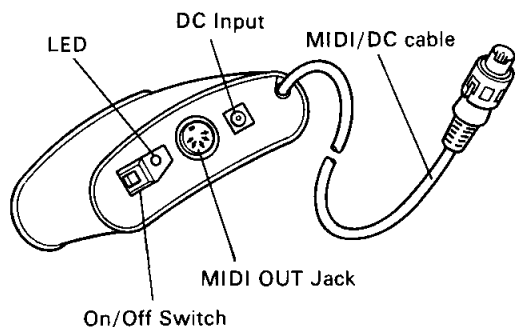

The MIDI/Power Pack supplies the required power (9 volts DC) to the WX7 and sends the WX7's MIDI data out to your MIDI synthesizer or tone generator. The MIDI/Power Pack normally runs on 6 "AA"-size batteries. You can also use an optional 12-volt AC adaptor (Yamaha PA-1). A third possibility is to use rechargeable batteries. In this case we suggest that you always keep a spare set of fully-recharged batteries handy.

When battery voltage becomes low, the LED on the MIDI/Power Pack will flash, signalling that replacement of the batteries is necessary. The lifespan of a dry cell battery is about 12 hours.

The MIDI/Power Pack is connected to the WX7 by means of a 1.5 meter (4 1/2 feet) MIDI/DC cable, which attaches to the compact, specially-constructed MIDI/DC terminal on both units.

The MIDI/Power pack has an on/off switch with an accompanying LED to indicate when the power is on, a DC input jack for the PA-1 adaptor, and a MIDI OUT terminal to which you connect a standard MIDI cable (the other end of which is connected to the MIDI IN terminal of your MIDI synthesizer or tone generator).

Also included is a soft case which has slots in the back for attaching the MIDI/Power Pack to your belt.

Six "AA"-size batteries are supplied. Insert the batteries into the MIDI/Power Pack in the configuration printed on the inside case of the battery compartment. During regular use, keep a spare set of batteries in the carrying case. When not using the WX7 for long periods, remove the batteries and store them in the carrying case.

MIDI/DC EXTENSION CORD

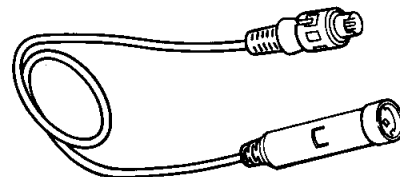

This cord allows you to increase the length of the MIDI/DC cord connecting the MIDI/Power pack to the WX7. Like the MIDI/DC cord, it has the dual function of supplying the WX7 with power and transmitting its MIDI data to the MIDI/Power pack. This cord has a length of 5 meters (15 feet). Extra cords can be purchased and used (up to a suggested maximum of three).

MIDI CABLE

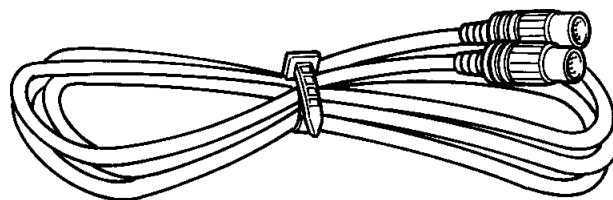

The MIDI cable supplied with your WX7 is a standard 3-meter (9 feet) cable. To avoid any degradation of the MIDI signal use only this cable, or a similar high-quality MIDI cable, to connect the WX7 to your MIDI synthesizer or tone generator.

MOUTHPIECE AND MOUTHPIECE COVER

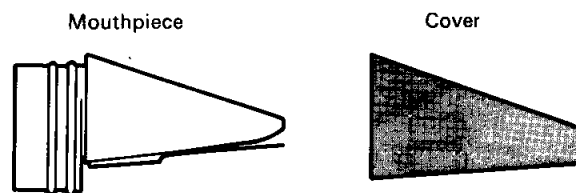

Made of durable, scratch-resistant plastic, the WX7's mouthpiece has a permanently attached plastic reed and a special cover to protect the mouthpiece when not in use. Two mouthpieces are supplied; the second can be kept as a spare, or used by a second player. Keep the mouthpiece attached to the WX7 when not in use or when storing in the hard case. The mouthpiece protects the lip sensor from damage.

KEY ADJUSTMENT SHIMS

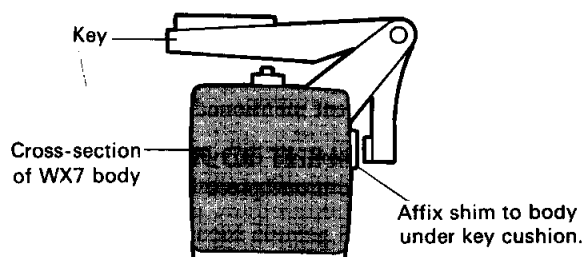

Two sets of 14 key adjustment shims allow you to make minute adjustments of each key's playing height. 0.2 mm and 0.5 mm thick shims are provided, enabling you to set each key to one of three playing heights, to exactly suit your playing style. The shims are self-adhesive. Simply remove the plastic covering from the shim, and stick it firmly on the body of the WX7 just under the pad opposite the key you want to adjust, as shown in the above diagram.

DRAIN PLUGS

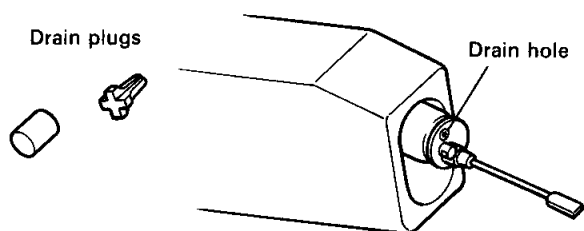

Two types of Drain Plugs are included: one that fully blocks the Drain Hole (with a circular cross-section), and one that partially blocks it (with a cross-shaped cross-section). In normal use (without plugs) the WX7 behaves like a regular saxophone: the air passes down the body of the instrument and out of the lower drain hole. Partially closing the upper drain hole creates a tighter blowing feel. Completely closing the drain hole creates an even tighter feel, suitable for saxophone players who tend to blow hard. Experiment with these options and select the one that suits you.

The plugs are inserted into the drain hole while the mouthpiece is detached. The mouthpiece is detached by gently and firmly sliding it out from the top of the WX7.

TAKE CARE NOT TO TOUCH THE THIN LIP SENSOR EXTENDING FROM THE INSTRUMENT. This device (which measures subtle variations in lip pressure) is delicate and can easily be bent or damaged.

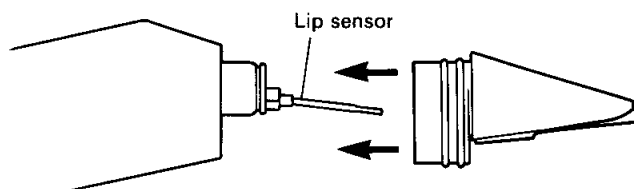

Make sure to push the plug as far in as it will comfortably go without forcing. Keep the drain plugs in their compartment in the carrying case when not in use.

INFORMATION BOOKLET AND CASSETTE TAPE

An informative booklet, **Expressive FM Applications**, and an accompanying cassette tape have been included. The booklet provides important playing and editing tips for most effectively using your tone generator with the WX7, and the cassette tape includes recorded performances of the WX7 as well as specially programmed TX81Z and DX7II voice data.

SCREWDRIVER

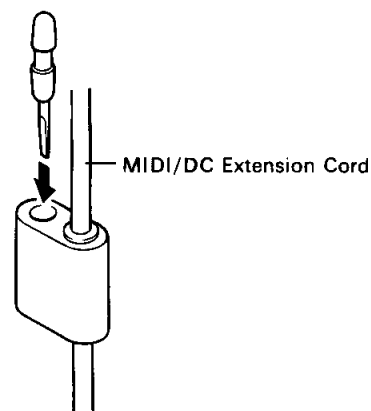

The screwdriver is located on a plastic holder attached to the MIDI/DC extension cord.

The screwdriver is used to adjust the four rotary pots (which control the lip pressure and breath pressure: refer to the **ADJUSTING THE PLAYING RESPONSE** section) and to change the positions of the DIP switches (see **THE DIP SWITCHES** section). Always keep the screwdriver in the plastic holder on the MIDI/DC extension cord.

PLAYING STRAP

A playing strap is included to hold the WX7 while playing. Connect the strap to the ring on the back of the instrument as shown in the rear view illustration in the **GUIDE TO THE CONTROLS** section.

CARRYING CASE

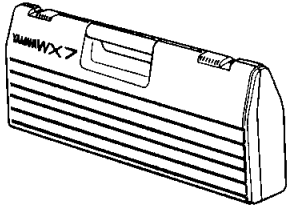

The WX7 carrying case is a light and durable case designed to hold the WX7 plus all accessories, so you can easily carry everything you need to your concert or recording session. When not using the WX7, always store it in the carrying case to protect it from damage from dust and impact. Use the special compartments in the carrying case to store the accessories. We recommend that the inside of the carrying case be cleaned at regular intervals, using the supplied polishing cloth (a slightly damp cloth may be used to remove stains).

POLISHING CLOTH

Use this special anti-static soft polishing cloth to clean all parts of your WX7, before and after every performance or session. Difficult stains may be removed with a slightly damp cloth, then dried with this polishing cloth. If the polishing cloth becomes soiled, it can be washed by hand in lukewarm water.

This section gets you playing the WX7 in minutes, without having to study the detailed information in the rest of this manual. Refer to the **GUIDE TO THE CONTROLS** and **ACCESSORIES AND MAINTENANCE** sections for explanations of the equipment mentioned in this Quick Guide.

1. Remove the WX7 from its carrying case and carefully but firmly attach the mouthpiece by sliding it into position.
2. Insert the six batteries into the MIDI/Power Pack, in the direction indicated in the battery compartment.
3. Use the MIDI/DC cable to connect the WX7 to the MIDI/Power Pack. The cable connections can be locked by turning the outer sleeve of the connectors in a clockwise direction.
4. Use the MIDI cable to connect the MIDI OUT terminal of the MIDI/Power Pack to the MIDI IN terminal of your MIDI synthesizer or tone generator.
5. Check the following conditions on your MIDI synthesizer or tone generator:
 - (i) It is set to receive MIDI data on MIDI channel 1, or on all 16 MIDI channels (Omni mode).
 - (ii) It is connected to a sound system.
 - (iii) A voice (program) has been selected which responds to Breath Control.
6. Turn on the power on the WX7's MIDI/Power Pack (its LED will light) then turn on your MIDI synthesizer or tone generator, and sound system.
7. You can now play your WX7. Experiment with varying lip pressure, breath pressure, the Octave Transpose keys, Pitch Bend Wheel, and the Hold Key. While holding down the Program Change key, press the Octave Transpose key to change the voice (program) on your MIDI synthesizer or tone generator.
8. After you have satisfactorily produced a variety of performances from your WX7, go on to read the rest of this manual in detail, so as to get a full understanding of this versatile and powerful MIDI instrument.

SETTING UP

In this section you will learn how to prepare the WX7 for playing, and connect it up to your MIDI synthesizer or tone generator. Information will also be given on how to set up your MIDI sound source to be controlled by the WX7.

CONNECTION OF THE MIDI/POWER PACK

Plug the MIDI/DC cord coming from the MIDI/DC Power Pack into the MIDI/DC jack of the WX7. In both cases, the connection can be locked by turning the outer sleeve of the connecting plug.

A strap on the case of the MIDI/Power Pack lets you attach it to your belt. You can also use the 5-meter (15-foot) MIDI/DC extension cord which allows you to put the MIDI/Power Pack in any convenient location. Extra MIDI/DC extension cords may be purchased, but it is not recommended that you use more than three extension cords, as MIDI signals may deteriorate if the cable length is more than 15 meters (45 feet).

CONNECTION TO THE MIDI SOUND SOURCE

Use the supplied MIDI cable or any standard MIDI cable to connect the MIDI OUT jack of the MIDI/Power Pack to the MIDI IN jack of your MIDI synthesizer or tone generator. The diagram below shows how the WX7 can be connected for controlling a TX81Z tone generator, but a virtually limitless number of other configurations using many different kinds of MIDI devices are also possible. Please refer to the MIDI AND APPLICATIONS section for more information on how to use the WX7 with a MIDI system.

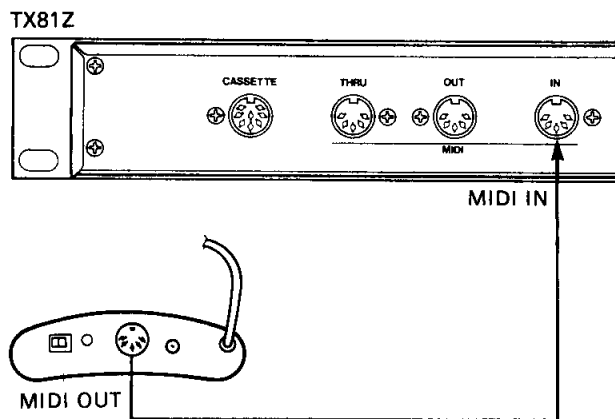

SETTING THE MIDI SOUND SOURCE

Three vital points must be remembered when setting up your MIDI Synthesizer or tone generator to be controlled by the WX7:

- (1) MIDI data can actually be sent on any of 16 "MIDI channels", allowing instruments within a complex MIDI system to communicate independently. When two MIDI instruments communicate, they should be set to the same MIDI channel. The WX7 normally TRANSMITS MIDI data on MIDI channel 1, so your MIDI sound source should be set to RECEIVE MIDI data on MIDI channel 1 (or it can be set to OMNI, a MIDI mode which allows it to receive MIDI data on all 16 MIDI channels).

In the Dual Play mode, the WX7 can be used to transmit MIDI data on two separate MIDI channels. You can also change the MIDI Transmit channel of the WX7. Refer to THE DIP SWITCHES section (DIP Switches #5 and #6) for more information.

- (2) The MIDI sound source should normally be set to receive MIDI Breath Control data. On the Yamaha DX7II synthesizer, for example, this is known as "BC" and can be independently set for each voice. Four parameters (functions) can be controlled by BC, as follows:

- Pitch Modulation (vibrato level)
- Amplitude Modulation (tremolo level)
- EG Bias (volume and/or timbre)
- Pitch Bias (Pitch)

Each parameter can be individually set, over a wide range. The setting of BC parameters directly affects the way breath pressure from the WX7 will control the selected voice.

- (3) The maximum amount of Pitch Bend that can be created by lip pressure or by use of the Pitch bend Wheel on the WX7 is set by adjusting the Pitch Bend parameter on your MIDI sound source. For example, on the DX7II synthesizer, Pitch Bend can be adjusted over a range of 1 thru 12 half-steps (semitones). Each of the DX7II's 64 voices can be set to a different Pitch Bend level, to suit both the timbre of the voice, and your playing style.

USE OF NON-BC COMPATIBLE MIDI DEVICES

If your MIDI sound source cannot receive BC data, but can receive After Touch and MIDI Volume data, the WX7 can be switched to transmit these types of MIDI data. Refer to DIP Switches #1 and #2 in THE DIP SWITCHES section.

In this case, you should set the After Touch and MIDI Volume parameters for each voice on your MIDI sound source.

PLAYING THE WX7

After you have made all the connections between the WX7, the MIDI/Power Pack, your MIDI tone generator, and your sound system, you are ready to play your WX7.

POWER ON

Turn on the power to your connected MIDI synthesizer or tone generator, and to your sound system. Then turn on the power to the WX7, using the power switch on the MIDI/Power pack.

If the LED next to the switch does not light or is flashing, this indicates that the batteries are dead, or, inserted incorrectly. If you're using a PA-1 AC Convertor, check to see that it is properly connected to the wall socket. Turn the WX7 power off, replace the batteries (or check that the PA-1 AC Convertor is correctly connected to the MIDI/Power pack and to the wall socket) then turn the WX7 power on.

BASIC PLAY OPERATION

Producing notes with the WX7 depends on three conditions:

- (1) Your connected MIDI synthesizer or tone generator is set to a program that will produce a sound via your sound system. This program **MUST** be one that is set to respond to MIDI Breath Control or After Touch data (refer to the **SETTING UP** section for more information on setting up your MIDI sound source).
- (2) You are blowing into the mouthpiece with breath pressure that is higher than the Wind Zero point (a breath threshold point that you can set by following the instructions in the **ADJUSTING THE PLAYING RESPONSE** section).
- (3) You are fingering the keys correctly so as to produce a note (the WX7 uses the standard Böhm fingering system plus some special fingering positions: refer to the **FINGERING CHARTS**).

No sound will be produced unless all three conditions are fulfilled.

In short, when you blow **AND** finger the keys correctly, a note will be heard. When you stop blowing **OR** fingering, the note will end. The note that you hear will respond to both lip pressure and breath pressure, as described in the following paragraphs.

LIP PRESSURE

The WX7's Lip Sensor lets you bend pitch up or down by biting the reed. It can be set for one of two modes: Tight Lip or Loose Lip. (See **THE DIP SWITCH** section, DIP Switch #8 for information on how to select Lip Modes.)

(1) TIGHT LIP MODE.

In the Tight Lip mode, the WX7 changes pitch much like a normal saxophone does. For normal playing at concert pitch, a regular embouchure may be used (i.e. a certain amount of bite is applied to the reed). Relaxing pressure on the reed will lower the pitch and increasing pressure will raise the pitch.

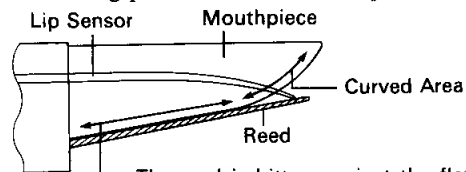

The reed is bitten against the flat area of the mouthpiece. When bite is relaxed, the reed bends down, flattening pitch. When bite is increased, the reed bends up against the curved area of the mouthpiece, raising pitch.

There is a narrow "dead" zone in the center where small changes of bite don't alter the pitch. This "dead" zone makes it easy to remain at concert pitch. **LIP ZERO** sets the position of the central "data" zone. You can adjust the amount by which the reed responds to lip pressure (the Lip Gain parameter). Refer to the **ADJUSTING THE PLAYING RESPONSE** section for details on how to adjust both these parameters.

(2) LOOSE LIP MODE.

In the Loose Lip mode, the lower lip is loose, and for normal concert-pitch playing, no bite is applied to the reed. Pitch is bent by increasing the bite on the reed, and in this mode, pitch can only be bent upward. However, the range of pitch bend is greater than that in the Tight Lip mode. In this mode, the Lip Zero parameter lets you set the pitch from which lip pressure will create a pitch bend.

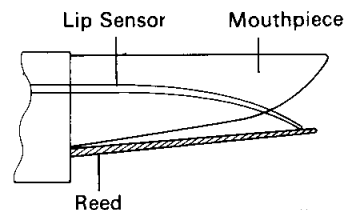

The reed normally stays in its lowest position. Any lip pressure bends the reed up, raising pitch.

Again, refer to the **ADJUSTING THE PLAYING RESPONSE** section for details on how to adjust the pitch bend response.

BREATH PRESSURE

The WX7's Wind Sensor allows you to use breath pressure to control volume, tone, vibrato and tremolo. Refer to the **SETTING UP** section, and consult the owner's manual supplied with your MIDI synthesizer or tone generator, for information about which parameters may be affected by Breath Control (BC) data.

When first trying out your WX7, set the parameter values on your MIDI sound source so that the results of a change in breath pressure will be obvious. For example, if you are using a Yamaha TX81Z FM Tone Generator, set the Pitch Modulation Depth to at least 70 and the LFO Speed to about 40. Increasing the breath pressure on your WX7 will create a pronounced vibrato effect on the TX81Z.

As with the Lip Sensor, the WX7's Wind Sensor has two response parameters which may be adjusted. The Wind Zero parameter lets you set the minimum amount of breath pressure needed to make a note speak. The Wind gain parameter lets you select the amount by which the WX7 will respond to a change in breath pressure. See the **ADJUSTING THE PLAYING RESPONSE** section for details.

PITCH BEND WHEEL

Pitch can be controlled by moving the Pitch Bend Wheel conveniently located under your right thumb. The Pitch Bend range must be set on your MIDI sound source (usually ± 1 to 12 semitones). The WX7's Pitch bend Wheel then operates in exactly the same way as the Pitch Bend Wheel on a synthesizer such as the Yamaha DX7II (i.e., when you push the wheel past the "dead zone" in the center position, pitch is bent; on releasing the wheel, it returns automatically to the center position).

NOTE: When the Pitch Bend Wheel is at its maximum or minimum setting, the Lip Sensor will not bend the pitch any higher or lower than that setting.

PROGRAM CHANGE KEY

Use the Program Change key (with the Octave Transpose keys) to change the voice programs on your MIDI sound source. Holding down the Program Change key alters the function of the Octave Transpose keys. With the Program Change key held down, the top Octave Transpose key is used to select program number 1, the Octave Transpose key below that is used to select program number 2, and so on down to the last Octave Transpose key, which is used to select program number 5. Normally the right thumb is used to hold down the Program Change key (see the **GUIDE TO THE CONTROLS** section).

NOTE: No sound can be produced when changing programs.

The Program Change key can also be used as an easy (and silent) way to find out if you have correctly made all MIDI connections and MIDI channel settings. By holding down the Program Change key and pressing one of the Octave Transpose keys on the WX7 you should see the attached tone generator change its internal programs.

OCTAVE TRANSPOSE KEYS

While playing the WX7, you can instantly transpose the instrument to other octaves by pressing the Octave Transpose keys. Pitch can be lowered by one or two octaves or raised by one, two or three octaves. The Octave Transpose keys are located on the rear of the WX7 and can be pressed singly or in succession by rolling or sliding the left thumb across them (see the **GUIDE TO THE CONTROLS** section). With this feature, you can create very rapid octave changes while you play. The Octave Transpose function increases the total range of the WX7 to over 7 octaves.

WHOLE TONE/SEMITONE UP KEYS

The WX7 has whole tone/semitone up keys which can be used either for execution of trills or for alternative fingering of notes. These are conveniently located in a central position (see the **GUIDE TO THE CONTROLS** section). Unlike on a normal saxophone, the same keys are used regardless of the pitch of the note that is being trilled (yet another of the advantages of MIDI!).

Two trill keys are provided: the lower key raises the pitch of the note by a semitone; the upper trill key raises the pitch by a whole tone.

HOLD KEY

The Hold key lets you sustain a selected note for use in the Key Hold and Dual Play modes. This note will be sustained until you press the Hold key a second time. Other special effects such as parallel harmony and breath-controlled sustain can be used. Refer to **THE DIP SWITCHES** section, DIP switches #5 and #6 for more information about the Key Hold and the Dual Play modes. The Hold key is normally played by the right thumb (see the **GUIDE TO THE CONTROLS** section).

THE DIP SWITCHES

The DIP switches are eight tiny switches (similar to those found on computers) located under a cover on the upper back of the WX7, just above the Octave Transpose keys.

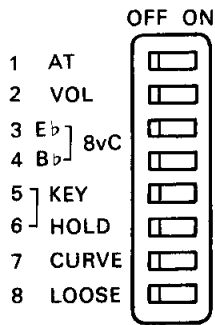

Use the WX7's screwdriver to move these switches. Be sure to replace the screwdriver in its holder after use. For each DIP switch, set the switch to the left for the OFF position; to the right for the ON position.

The DIP switches control the type of data sent out, transpose to pitches other than concert pitch, set the Dual Play type, select how the WX7 will respond to breath (Wind Curve), and select the Lip Sensor mode. Each of these functions is described in more detail below.

DIP SWITCH #1 — Breath Control/After Touch

You can use the WX7 not only to play notes from your MIDI device but also alter the tonal character, volume and pitch by breath pressure. The WX7 monitors changes in breath pressure and sends them out as MIDI Breath Control data. Yamaha MIDI instruments such as the DX7II Digital Programmable Algorithm Synthesizer or the TX81Z and TX802 FM Tone Generator respond to Breath Control data. However, if your tone generator doesn't respond to Breath Control data, this switch will let the WX7 send breath pressure changes as After Touch data.

Set DIP Switch #1 to one of the following positions:

- OFF: the WX7 sends Breath Control data.
- ON: the WX7 sends After Touch data.

DIP SWITCH #2 — MIDI Volume

You can use breath pressure to control the volume of your tone generator while simultaneously controlling another parameter (such as pitch or tone). This feature allows you to still take advantage of the dynamically expressive control of MIDI for those voices that don't respond to Breath Control or After Touch data. Voices that do respond to Breath Control or After Touch data will also respond to MIDI Volume data when this switch is turned on.

Set DIP Switch #2 to one of the following positions:

- OFF: the WX7 does not send MIDI Volume data.
- ON: the WX7 sends MIDI Volume data.

DIP SWITCHES #3 AND #4 — Transpose

The normal playing key of the WX7 is C (corresponding to that of a flute or oboe). Using DIP Switches #3 and #4, you can transpose UP to E flat (corresponding to soprano, alto and baritone saxophones), DOWN to B flat (corresponding to soprano, tenor and bass saxophones, and clarinet) or UP by an octave.

Set DIP Switches #3 and #4 to the following positions:

DIP SWITCH #3	DIP SWITCH #4	KEY
OFF	OFF	C
ON	OFF	B flat
OFF	ON	E flat
ON	ON	C (octave up)

DIP SWITCHES #5 AND #6: Key Hold Modes

The Key Hold facility is a unique and exciting feature of the WX7. With it you can have a note memorized for as long as you like while you play other notes together with it. To use the feature, press and release the Hold key while playing a note. According to the settings of DIP switches #5 and #6, the held note will be played every time you play another note until you press and release the Hold key a second time. Pitch bending, by Lip Sensor and Pitch Bend wheel, affect both notes simultaneously.

NOTE: this function will NOT work if the connected MIDI sound source is set to MONO (monophonic play).

Key Hold has four modes: NORMAL, FOLLOW, DUAL (NO BREATH) and DUAL (USE BREATH). The following chart shows the functions of these four modes, with full explanations in the subsequent text.

KEY HOLD MODE FUNCTIONS

MODE	PITCH OF HELD NOTE	CHARACTER OF HELD NOTE	NUMBER OF MIDI TRANSMIT CHANNELS
NORMAL	Fixed at selected pitch.	Affected by breath pressure.	One
FOLLOW	Follows lead line at selected interval.	Affected by breath pressure.	One
DUAL PLAY (NO BREATH)	Fixed at selected pitch.	Sustained continuously; not affected by breath pressure.	Two
DUAL PLAY (USE BREATH)	Fixed at selected pitch.	Affected by breath pressure.	Two

NORMAL MODE: In the Normal Mode, the WX7 holds only that note that was played when the Key Hold button was pressed. For example, if you press the Hold key while playing middle C, all succeeding notes will be accompanied by a middle C until the Hold key is pressed a second time.

[NORMAL MODE]

Hold key pressed. Middle C is played together with lead line. Hold key pressed again. Solo lead line continues.

FOLLOW MODE: In the Follow Mode, the WX7 remembers the first note that you play, plus the interval between that note and your second note, the held note will then follow all subsequent notes at that interval. For example, if you press the Hold key while playing middle C, then play a G above middle C, this sets the FOLLOW interval at a major fifth. All notes played after that will be accompanied by a harmony note a fifth above the note played until the Key Hold button is pressed a second time. Once you get familiar with this mode, you'll be able to change the FOLLOW interval by judicious use of the Hold key, to create complex and expressive harmony passages.

[FOLLOW MODE]

Hold key pressed. Second note creates interval of a 5th. Lead line is accompanied by a harmony a 5th above. Hold key pressed again. Solo lead line continues.

DUAL PLAY (NO BREATH) MODE: The same as the Normal Mode except that the WX7 transmits data for the lead line and the held note on two separate MIDI channels (see MIDI TRANSMIT CHANNEL SELECTION later in this section) allowing you to play two separate MIDI synthesizers or tone generators. Also, the held note is continuously sustained under the lead line, and is unaffected by breath pressure. For example, you could use this mode to sustain a string note, while playing a lead line using a flute voice. The sustained note ends only when you press the Hold key a second time.

[DUAL PLAY (NO BREATH) MODE]

Hold key pressed. Middle C is sustained continuously under the lead line. Hold key pressed again. Sustained middle C is cut. Solo lead line continues.

DUAL PLAY (USE BREATH) MODE: Identical to the NORMAL Mode, except that the MIDI data is sent on two separate MIDI channels, allowing you to create harmony passages using two separate instrument sounds. The tonal qualities and volumes of the tone generators being controlled over both MIDI channels in this and the NORMAL Mode will change according to breath pressure; for example, notes that are slurred will sustain and notes played in staccato fashion will be interrupted for both the held note and the played note.

Set DIP Switches #5 and #6 to the following positions:

DIP SWITCH #5	DIP SWITCH #6	KEY HOLD MODE
OFF	OFF	NORMAL
ON	OFF	FOLLOW
OFF	ON	DUAL (NO BREATH)
ON	ON	DUAL (USE BREATH)

• MIDI TRANSMIT CHANNEL SELECTION:

In both the DUAL PLAY modes, the lead line is transmitted on MIDI channel 1 and the held note on MIDI channel 2. However, the WX7 can be set to transmit on MIDI channels 3 and 4 instead, in the following manner:

Turn the WX7's power off. Then, while simultaneously holding down the Hold and Program Change keys, turn the power on. The WX7 will now transmit the lead line (and normal monophonic play) on MIDI channel 3, and held notes on MIDI channel 4. To return to MIDI channels 1 and 2, repeat the above operation. This operation may also be used to switch the MIDI channel for normal monophonic play between MIDI channels 1 and 3.

ADJUSTING THE PLAYING RESPONSE

DIP SWITCH #7 — Wind Curve Select

This feature allows you to select one of two breath response settings. These are curves that determine the continuous sensitivity of the response of the WX7 to breath pressure. DIP Switch #7 allows you to change the shape, not the range, of the Wind Curve. The actual range of the Wind Curve is set using the WIND GAIN parameters (see the ADJUSTING THE PLAYING RESPONSE section).

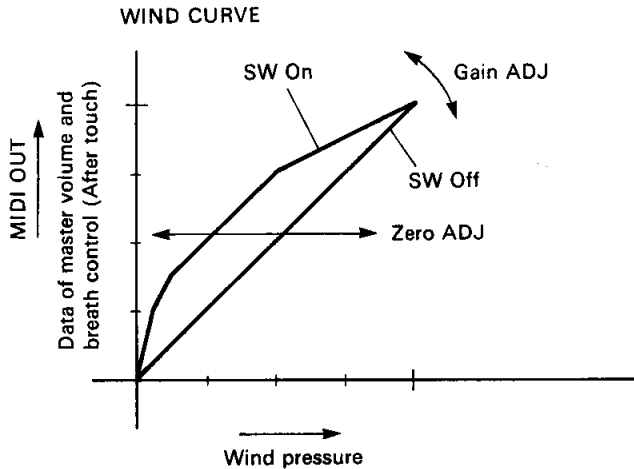

Set DIP Switch #7 to one of the following positions:

- OFF: Linear response
- ON: Exponential response

DIP SWITCH #8 — Loose Lip/Tight Lip

This switch lets you select the Loose Lip mode or Tight Lip mode, offering two different techniques for creating pitch bends by lip pressure on the WX7's mouthpiece. (See the PLAYING THE WX7 section for more information on these modes.) The range settings of these modes are explained in the ADJUSTING THE PLAYING RESPONSE section.

Set DIP Switch #8 to one of the following positions:

- ON: Loose Lip Mode
- OFF: Tight Lip Mode

The sensitivity of the Wind and Lip Sensors can be finely adjusted to perfectly suit your style of playing. Four rotary pots, located under a cover on the upper back of the WX7 (next to the DIP switches), control the playing response for the sensors.

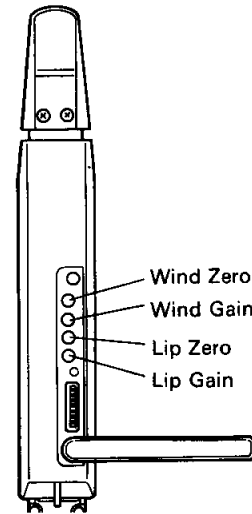

For each pot, turning the pot clockwise increases the parameter value; turning the pot counter-clockwise decreases the parameter value. Use the WX7's screwdriver to adjust these pots (be sure to replace the screwdriver in its holder after use).

ADJUSTING THE WIND SENSOR

The following graph indicates the effect of the Wind Zero and Wind Gain pot adjustments on the Wind Sensor response:

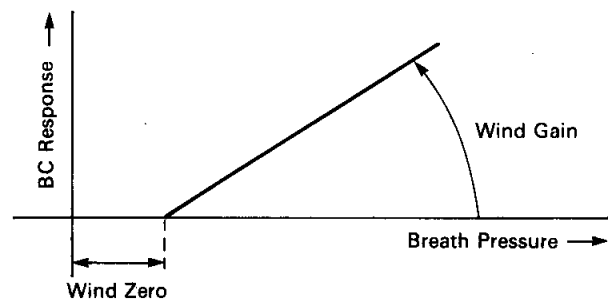

WIND ZERO: The Wind Zero pot sets the breath threshold. This is the point at which breath pressure causes a note to speak (i.e., a MIDI Note On signal is sent to the connected MIDI synthesizer or tone generator). Set at the minimum level, the instrument will sound with no breath pressure. Set at the maximum level, considerable breath pressure is required to start a note. Begin by setting the Wind Zero somewhere in the middle range, for the most comfortable breath threshold.

WIND GAIN: The Wind Gain pot controls the amount of effect that changes in breath pressure will produce. Begin by setting the Wind Gain to a mid-range value, then adjust it for the most natural response to changes in breath pressure. While adjusting Wind Gain, be sure to select a voice (on your MIDI sound source) that responds well to BC (Breath Control) data. If your synthesizer or tone generator's BC parameters are set to their minimum values, no amount of Wind Gain will produce any BC modulation effect. Conversely, if the Wind Gain setting is at its lowest, even the highest BC parameter settings on your synthesizer or tone generator will produce no modulation.

NOTE: The Wind Gain response of the WX7 can be set to two different "Wind Curves". See THE DIP SWITCHES section, DIP switch #7, for more information.

ADJUSTING THE LIP SENSOR

The following graphs indicate the effect of the Lip Zero and Lip Gain pot adjustments on the Lip Sensor response, for each of the two playing modes (Tight Lip and Loose Lip modes). These modes are explained in the PLAYING THE WX7 section, and are selected using DIP switch #8 (see THE DIP SWITCHES section for details).

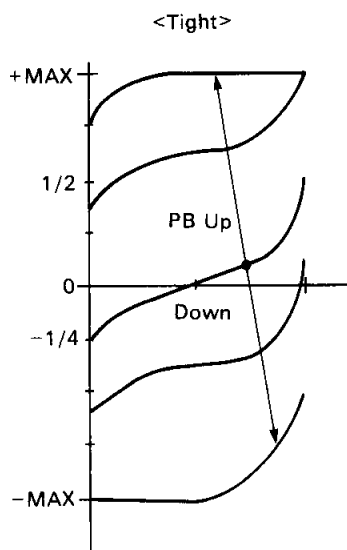

For the Tight Lip mode, the pots function as follows:

LIP ZERO: Lip Zero sets the central pitch from which pitch bends will be made. With the use of a tuner to accurately set concert pitch, rotate the LIP ZERO pot clockwise to lower the pitch and counterclockwise to raise the pitch. If holding to the central pitch is difficult (in other words, if the "dead" zone is too narrow), rotate the LIP GAIN pot counterclockwise to make it easier to keep to the central pitch, or lower the pitch bend range of the tone generator.

LIP GAIN: The Lip Gain pot controls the amount of pitch bend that changes in lip pressure will produce. Turning the pot in a clockwise direction increases the amount of pitch bend. At the maximum setting, pitch will be affected even by very slight changes in lip pressure. Begin by setting the Lip Gain to a mid-range value, then adjust it for the most natural response to changes in lip pressure. While adjusting Lip Gain, be sure to select a voice (on your MIDI sound source) that responds well to PB (Pitch Bend) data. If your synthesizer or tone generator's PB range is set to the minimum value, no amount of Lip Gain will produce any PB effect.

NOTE: The LIP ZERO and LIP GAIN parameters are interactive, so it is necessary to them one after the other.

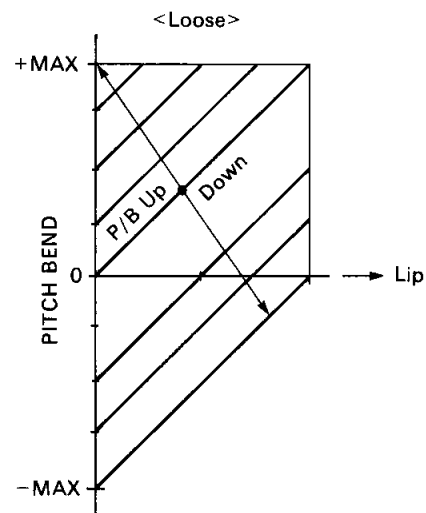

For the Loose Lip mode, the pots function as follows:

LIP ZERO: The Lip Zero pot sets the lip pressure threshold. This is the point at which an increase in lip pressure causes the pitch of a note to rise. Set at the minimum level, the slightest amount of lip pressure will cause an increase in pitch. Set at the maximum level, considerable lip pressure is required to raise the pitch of a note. Begin by setting the Lip Zero somewhere in the middle range, for the most comfortable lip pressure threshold.

LIP GAIN: See the comments about Lip Gain setting for the Tight lip mode.

MIDI AND APPLICATIONS

The Musical Instrument Digital Interface (MIDI), first brought out in 1982, has proved to be one of the most important developments in electronic music. Using the power of MIDI, a single musician can carry out an unlimited number of previously impossible performance operations, including the following:

- Play several synthesizers at one time from a single keyboard controller.
- Control performance functions such as pitch bend and modulation on the remote synthesizers as expressively as if they were being played directly.
- Change voices on remote synthesizers and tone generators, for impressive and effortless sound changes in real time.
- Connect synthesizers with sequencers or MIDI-compatible computers, for flawless, noise-free recording and playback of both music data and program change data, with automatic timing correction (quantizing) and enormously flexible editing facilities.
- Control digital drum machines for a perfectly synchronized performance.
- Set effects devices such as digital delay and digital reverb units to change their effects programs along with voice program changes, to add just the right processing to each voice program.
- Use a Tape Sync signal recorded onto one channel of a multitrack tape deck, to perfectly synchronize MIDI sequencers and drum machines with a vocal or acoustic performance recorded on tape. In this way, the seemingly opposed worlds of traditional acoustic music and state-of-the-art digital music can be blended and merged, providing enormous creative potential.

As you can see, MIDI is a very powerful musical tool. However, you won't need a course in computer science to use your WX7 effectively with other MIDI instruments. All you need to know is what MIDI devices can do, and how you can control them with your WX7. After that, MIDI does all the work for you.

In every MIDI setup there is a master and a slave. The master can be a keyboard, sequencer, computer — or a WX7 — and the slave (a sound-generating instrument) is played by it.

The master transmits MIDI messages to the slave in the form of computer type signals. The messages depend on how the instrument is being played, which keys are pushed, etc. In the case of the WX7, Note On and Note Off messages are sent at the start and end of each breath respectively, indicating to the slave the start and end of each note. A Program Change message is sent every time you press the Program Change and Octave Transpose keys. When a continuous message needs to be sent (such as when you are moving the Pitch bend Wheel, or gradually changing breath pressure) MIDI technology "slices" the continuous change into thousands of slices

per second, and simply transmits a number corresponding to the current position of the control (together with a message indicating which control is currently being altered).

You should know how the MIDI messages transmitted by the WX7 affect the sound of the slave (i.e., your MIDI synthesizer or tone generator) and how you can program your MIDI instrument to respond to these messages. For that information, please consult the owner's manuals of your MIDI instruments.

In essence, MIDI is extremely simple: it simply reduces all musical data to numbers, which can easily be sent from one instrument to another (hence the term "Digital Interface"). In practice, MIDI is unbelievably versatile, which is as it should be, for it is designed to fulfill the demands of professional musicians. Indeed, new uses of MIDI are being discovered at an extraordinary rate, both by MIDI engineers, and by musicians like yourself, experimenting and refining the art of digital music on stages and in studios around the world.

A short explanation of some of the possibilities of MIDI will perhaps be helpful in triggering some ideas on how best to use your WX7. In the following system setups, the WX7 is used to change voice programs on tone generators and synthesizers and, at the same time, call up custom effect settings like chorusing, repeat delays, and reverb on digital effect units (for example, the REX 50, the SPX90II, and the REV 5).

1. WX7 PLUS TX81Z MULTI-TIMBRAL FM TONE GENERATOR.

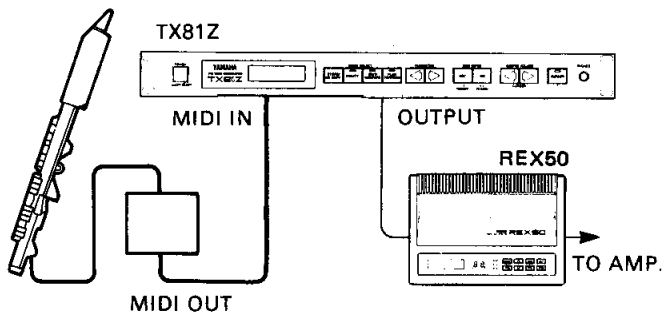

In this basic yet versatile arrangement, the WX7 is used to control the Yamaha TX81Z FM Tone Generator, which can create up to eight superb FM voices simultaneously. The eight voices could be set to different octaves for a full, powerful sound.

Programming each voice to occupy a separate register of the WX7's 7-octave pitch range also allows you to experiment with various split and layer combinations. For example, program a bass sound for F0 to C2, piano and cello sounds layered together in the C#2 to C4 range, 4 different string sounds between C#4 and F5, and a clarinet sound at the top. Depending on which register you play in, you can get four distinct sounds. Voices can also be set to overlap, for added tonal interest.

You could also transpose four of the TX81Z's voices to form a chord. Assign these chordal voices to MIDI channel 2, and the other four voices to MIDI channel 1. With the WX7 in the Dual Play mode, you could then add chordal harmonies your rich 4-voice lead line.

2. WX7 PLUS DX7II SYNTHESIZER

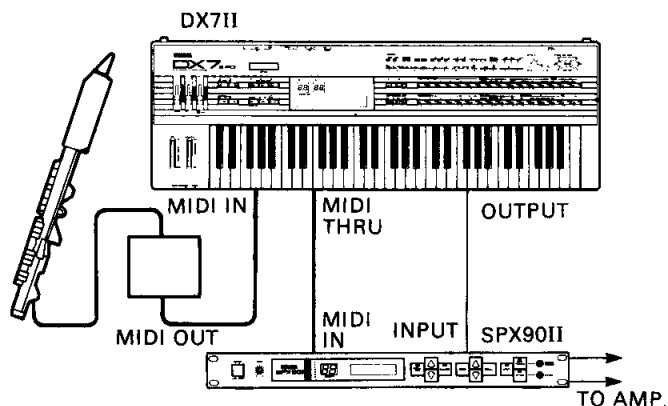

The world-famous Yamaha DX7II Digital Programmable Algorithm Synthesizer has a feature that makes it an ideal match for the WX7: reception of music data on two separate MIDI channels, for independent control of two voices. For example, use the WX7 in the Dual Play (No Breath) mode

to play a flute sound on MIDI channel 1 and a cello voice on channel 2. Press the Hold Key to create a cello drone, while playing a flute melody above it.

Also, the DX7II has an innovative Pitch Bias feature, allowing you to use Breath Control to affect pitch as well as other parameters (vibrato, tremolo, etc). In this way, pitch control can be executed from the WX7 using breath pressure as well as lip pressure and Pitch bend Wheel, for expanded expressivity.

3. WX7 PLUS TX802 FM TONE GENERATOR SYSTEM

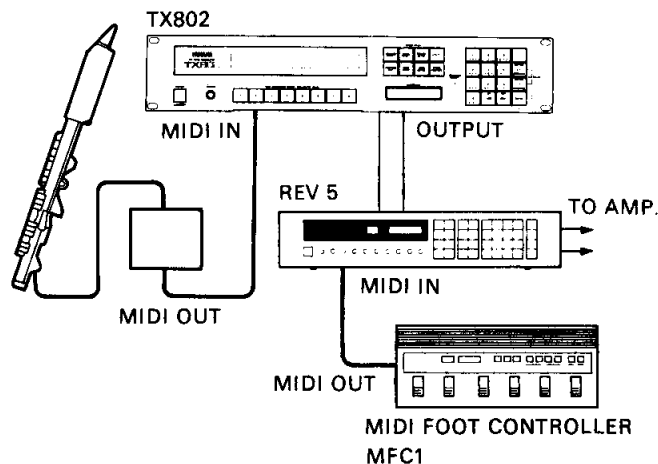

Like the TX81Z, the TX802 FM Tone Generator can create eight FM voices, but with even greater richness and tonal possibilities. For example, you could use the TX802 to create an eight-sound drum or percussion set. Assign each drum sound to a different note (perhaps to a convenient eight-note scale). With the WX7's Breath Control ability, you can "hit" each instrument of the drum set with different strengths, creating amazingly realistic dynamic changes.

Also, the TX802's unique Alternative Assign feature means that every time you play a note, a different voice is selected. For example, you could use eight slightly different string voices, so that when you play a string melody, the sound changes in a subtle, vibrant fashion, enhancing the effect of a live string orchestra.

GLOSSARY

after touch: A type of touch sensitivity in which the pressure applied to the key after it has reached and is resting on the keybed is sensed. This, depending on what function settings have been programmed into a synthesizer, is used to change parameters of the sound (such as volume, pitch, or timbre). Also applies to a category of MIDI messages. The WX7 can be set to transmit after touch data instead of breath control data.

algorithm: See FM.

breath control: A type of MIDI message which is used to control function parameters of a synthesizer's sound (usually vibrato depth, tremolo depth, volume and tone). Breath Control data is created by breath pressure, and can be sent by blowing into a breath controller (such as the BC1 or BC2 Breath Controllers, designed for use with the Yamaha DX7II synthesizer). In normal use, the WX7 sends Breath Control data.

breath controller: A MIDI controller device with a mouth-piece that can be blown into, producing a control signal. Normally, a breath controller sends only Breath Control data, but the WX7 can also send Note On and Note Off data, and can also be set to transmit After Touch data.

carrier: See FM.

channel: In MIDI, 16 channels are available for data transmission/reception. As on a TV set, a MIDI device can be set to receive (or send) only messages of the selected channel. In this way, one MIDI controller such as a QX5 Digital Sequence Recorder (on which stored MIDI data can be assigned to a number of different MIDI channels) can be used to independently control up to sixteen MIDI devices.

DIP switch: Dual In-line Package (a common integrated circuit) switch. In computer usage, a two-position switch which lets the user set current paths on or off. DIP switches are usually of compact proportions, requiring a screwdriver for setting, and as they are normally not requiring frequent, are access concealed under a detachable cover. In the WX7, eight DIP switches are incorporated, for selecting a variety of performance modes and functions.

FM: Stands for Frequency Modulation. This is a unique and versatile tone-generating system featured on Yamaha's DX series Synthesizers and TX series Tone Generators, and is based on the technology used in FM radio broadcasting. Voices are created by modulating the frequency of one "operator" by another "operator". Operators are high-frequency sine-wave oscillators. The ratio between the frequency of the operators determines the harmonic structure and tone of the resulting sound. The operator which is being modulated is called a "carrier" — it actually creates the sound. The operator which is modulating the carrier is called a "modulator". In the TX81Z Tone Generator, and lower-priced DX series synthesizers, four operators are available for each voice, allowing complex timbral possibilities. The operators can be grouped in various configurations

called "algorithms" (for example, one carrier modulated by three modulators, or two carrier/modulator pairs). The TX802 and TX816 Tone Generators, and professional range DX series synthesizers feature six operators, for added richness. The level and pitch of each operator can be modified in a wide variety of ways, enabling recreation of the complex and random harmonic changes over time that occur in acoustic instruments.

function parameter: An aspect of a synthesizer's sound that is usually changed while the sound is being played, for musical expression. Examples of these include pitch, volume, tone (EG Bias), and vibrato (pitch modulation).

initialize: To reset the parameters of a device to zero or to a predetermined basic setting.

LFO: Low-frequency oscillator. A waveform controller that oscillates at a "low" (usually sub-audio) frequency and is used mainly to produce vibrato, tremolo, and trills. On a DX7II synthesizer, you can adjust the speed and depth of the LFO, its waveform (sine, sawtooth, square, etc.) as well as the "delay" (the time it takes for the LFO to reach its full intensity, allowing vibrato, for example, to be gradually applied, for an extremely natural effect).

master: Any device (such as a keyboard, sequencer, or the WX7) that controls another device (the slave). The WX7, therefore, always functions as a master, by sending MIDI signals to a connected MIDI synthesizer or tone generator.

message: Any group of MIDI data that is sent or received within a MIDI system to initiate a selected function or to achieve a particular effect (e.g., pitch bend, program change, modulation, etc.).

MIDI: Musical Instrument Digital Interface. A worldwide standard digital "language" permitting digital information to be transmitted from one synthesizer to another, or between synthesizers, sequencers, drum machines, computers, etc.

MIDI IN: A MIDI terminal on a MIDI device, that receives MIDI data transmitted from an external MIDI device. For example, the TX81Z FM tone generator has a MIDI IN terminal to which you can connect the WX7, allowing you to use the WX7 to play the tone generators in the TX81Z.

MIDI OUT: A MIDI terminal on a MIDI device that transmits MIDI data. The WX7's MIDI/Power Pack has a MIDI OUT terminal, through which MIDI data is transmitted to a connected MIDI sound source.

MIDI THRU: A MIDI terminal on a MIDI device that relays, unchanged, the data received at its MIDI IN terminal. This enables you to connect several MIDI devices together in a "daisy chain" configuration, permitting a number of MIDI devices to be controlled by one master MIDI device such as the WX7.

mode: The manner in which a device is currently operating. In MIDI operation there are four modes, which describe how devices respond to data, are omni on/poly, omni on/mono, omni off/poly, and omni off/mono. When omni is on, the device responds to MIDI data arriving on any channel. When omni is off, it only responds to data arriving on the set channel. When poly is on, the device will play the maximum number of simultaneous notes (usually 16). When mono is on, it will play only one note at a time. Mode can also be used to describe other manners of operation, such as the Tight Lip Mode on the WX7.

modulation: The process of modifying the sound of a synthesizer. Some examples of modulation include pitch modulation (vibrato), amplitude modulation (tremolo), and brightness (called EG Bias on Yamaha DX series synthesizers and TX series tone generators).

modulation wheel: A wheel controller located on the left side of most keyboards. It sends a MIDI message to modulate the sound of a synthesizer, for vibrato or tremolo effects.

modulator: See FM.

monophonic: Also called mono. Capable of producing only one note at a time. Normally the WX7 is a monophonic instrument (when not set to the Dual Play mode).

note off: A MIDI message indicating the end of a note. This message is sent whenever a key is released on a MIDI keyboard. On the WX7, a Note Off message is sent when breath ceases to be applied to the mouthpiece. If the MIDI sound source has been programmed with a long "release" time, the note will continue and fade out, after the note off message is received. Also known as key off.

note on: A MIDI message indicating the start of a note. This message is sent whenever a key is pressed on a MIDI keyboard. On the WX7, a Note On message is sent when a note is fingered and breath is applied to the mouthpiece. If the MIDI sound source has been programmed with a long "attack" time, the note may take some time to fade in after receiving a note on message. Also known as key on.

operator: See FM.

parameter: An aspect of a synthesizer's sound that can be changed. Some parameters (called function parameters) can be changed while playing, whereas others (called voice parameters) can only be programmed to be a permanent part of the sound. Some examples of parameters include "LFO speed," "key transpose," and "portamento time."

pitch bend wheel: A controller on a MIDI instrument that is used to bend pitch up or down on a note as it is being played. The wheel is usually spring-loaded, so that it automatically returns to a central (concert pitch) position when released. In addition, there is usually a central "dead zone" so that very small changes in the position of the wheel will not affect pitch. On a DX7II synthesizer, the pitch bend range is variable between ± 1 to 12 semitones. The WX7 has a pitch bend wheel.

polyphonic: Also called poly. Capable of producing more than one note at a time. The DX7II is a typical MIDI polyphonic instrument in that it can produce up to 16 notes simultaneously. Although, for obvious reasons, only ten notes can be played at any one time, other notes may be required to sustain at the same time (for example, when using the sustain pedal on a piano voice), hence the need for more than 10 simultaneous notes. Also, when using a sequencer such as the QX5 Digital Sequence Recorder to play the DX7II, up to 16 independent melody lines could be transmitted, enabling performance of 16-part orchestral arrangements.

program: [1] (verb) A general term meaning to set parameter values in a MIDI instrument, in order to create a voice, select MIDI receive/transmit settings, etc. [2] (noun) see "voice".

setting: The number or value to which a parameter has been programmed.

slave: Any device (tone generator, drum machine, etc.) that is being controlled by another device called a master. The TX802 FM Tone Generator is a typical example of a slave — it has no keyboard or other playing device, and is basically a "black box" containing tone generators which produce FM voices which can be played by an external master-type device such as the WX7.

voice: [1] A synthesizer sound, preset, or patch program. [2] The basic sound generating portion of a synthesizer. For example, a monophonic synthesizer is a one-voice instrument, whereas the polyphonic DX7II has 16 voices.

SPECIFICATIONS

WX7 MAIN UNIT

- **SENSORS**

Wind Sensor (Breath Pressure); Lip Sensor (Lip Pressure)

- **CONTROLS**

Keys x 14; Pitch Bend Wheel; Key Hold; Program Change; Octave Transpose (-2 to +3 octaves)

- **TERMINALS**

DC In/MIDI Out (single connector)

- **MIDI TRANSMIT CHANNELS**

1 or 3 [Normal Mode];
1 + 2 or 3 + 4 [Dual Play Mode]

- **DIP SWITCHES**

After Touch; MIDI Volume; Transpose to B flat;
Transpose to E flat; Key Hold Normal/Follow;
Dual Play No Breath/Use Breath;
Wind Curve Select; Loose Lip/Tight Lip

- **ADJUSTABLE POTS**

Lip Zero; Lip Gain; Wind Zero; Wind Gain

- **DIMENSIONS (W x D x H)**

57 x 64 x 538 mm
(2-1/4" x 2-1/2" x 21-1/4")

- **WEIGHT**

380 grams
(13-1/2 oz.)

WX7 MIDI/POWER PACK

- **TERMINALS**

DC Out/MIDI In (single connector); MIDI OUT;
AC IN

- **SWITCH**

Power On/Off

- **POWER SOURCE**

EITHER: "AA" batteries (1.5 V) X 6
OR: 12V DC, using optional Yamaha PA-1 12V
Voltage convertor connected to one of the following power supplies:
120V, 50/60 Hz [U.S., Canada]
220V, 50/60 Hz [General]
240V, 50/60 Hz [Britain]

- **DIMENSIONS (W x D x H)**

111 x 34 x 95 mm
(4-3/8" x 1-3/8" x 3-3/4")

- **WEIGHT**

300 grams
(11 oz.)

ACCESSORIES

MIDI/Power pack w/soft case (1 ea.)
AA battery (6)
MIDI/DC extension cord (1)
MIDI cable (1)
Mouthpiece (1), attached
Extra mouthpiece (1)
Mouthpiece cover (1)
Adjustment shim (0.2 mm t x 14, 0.5 mm t x 14)
Drain plug (2)
Screw driver w/holder (1 ea.)
Polishing cloth (1)
Carrying case (1)
Playing strap (1)
Information booklet w/cassette tape (1 ea.)

MIDI Data Format

MIDI CHANNEL

MIDI channel output is basically done through channel 1, however, channel 2 is used when DIP Switch #6 is ON (DUAL NO/USE BREATH).

Furthermore, channel 3 is used when power is turned on while the keyhold switch and the program change switch are held. Channel 4 is used when DIP Switch #6 is ON, provided that channel 3 is used as a basic channel.

DETAILS OF OUTPUT MESSAGE

Note ON, OFF

1 0 0 1 0 0 * * \$90, 91 ;note on/off
(\$92, 93)
0 n n n n n n n \$nn ;note no. 20 — 122
0 v v v v v v v \$vv ;1 — 127 velocity
0 =note off

Control Change

1 0 1 1 0 0 * * \$b0, b1 ;control change
(\$b2, b3)
0 c c c c c c c \$cc ;control no.
2 =breath control
7 =master volume
0 d d d d d d d \$dd ;data 0 — 127

When SW1 is OFF, WIND data is output as breath control.
When SW2 is ON, WIND data is output with master volume.

Program Change

1 1 0 0 0 0 * * \$c0, c1 ;program change
(\$c2, c3)
0 0 0 0 0 d d d \$dd ;program no. 0 — 4

After Touch

1 1 0 1 0 0 * * \$d0, d1 ;after touch
(\$d2, d3)
0 d d d d d d d \$dd ;data 0 — 127

When SW1 is ON, WIND data is output as after touch.

Pitch Bend

1 1 1 0 0 0 * * \$e0, e1 ;pitch bend
(\$e2, e3)
0 l l l l l l l \$LL ;data LSB
0 m m m m m m m \$mm ;data MSB (resolution 7 bit)

System Exclusive

Condition Acknowledge

1 1 1 1 0 0 0 0 \$f0 ;system exclusive
0 1 0 0 0 0 1 1 \$43 ;YAMAHA ID
0 0 0 0 0 0 0 0 \$00 ;bulk dump
0 1 1 1 1 1 0 1 \$7d ;condition acknowledge
0 0 0 0 1 1 0 0 \$0c ;data bytes LSB
0 0 0 0 0 0 0 0 \$00 ;data bytes MSB
0 1 0 0 1 1 0 0 'L' ;message
0 1 0 0 1 1 0 1 'M'
0 0 1 0 0 0 0 0 ''
0 0 1 1 1 0 0 0 '8'
0 0 1 1 1 0 0 1 '9'
0 0 1 1 0 1 1 1 '7'

FCC INFORMATION

While the following statements are provided to comply with FCC Regulations in the United States, the corrective measures listed below are applicable worldwide.

This series of Yamaha professional music equipment uses frequencies that appear in the radio frequency range and if installed in the immediate proximity of some types of audio or video devices (within three meters), interference may occur. This series of Yamaha combo equipment have been type tested and found to comply with the specifications set for a class B computing device in accordance with those specifications listed in subpart J of part 15 of the FCC rules. These rules are designed to provide a reasonable measure of protection against such interference. However, this does not guarantee that interference will not occur. If your professional music equipment should be suspected of causing interference with other electronic devices, verification can be made by turning your combo equipment off and on. If the interference continues when your equipment is off, the equipment is not the source of interference. If your equipment does appear to be the source of the interference, you should try to correct the situation by using one or more of the following measures:

Relocate either the equipment or the electronic device that is being affected by the interference. Utilize power outlets for the professional music equipment and the device being affected that are on different branch (circuit breaker or fuse) circuits, or install AC line filters.

In the case of radio or TV interference, relocate the antenna or, if the antenna lead-in is 300 ohm ribbon lead, change the lead-in to the co-axial type cable.

If these corrective measures do not produce satisfactory results, please contact your authorized Yamaha professional products dealer for suggestions and/or corrective measures.

If you cannot locate a franchised Yamaha professional products dealer in your general area contact the professional products Service Department, Yamaha Music Corporation, 6600 Orangethorpe Ave., Buena Park, CA 90620, U.S.A.

If for any reason, you should need additional information relating to radio or TV interference, you may find a booklet prepared by the Federal Communications Commission helpful:

"How to Identify and Resolve Radio -- TV Interference Problems". This booklet is available from the U.S. Government Printing Office, Washington D.C. 20402 -- Stock No. 004-000-00345-4.

Function ...	Transmitted	Remarks
Basic Default	: 1	
Channel Changed	: 1 & 2 , 3 & 4	: X1
Mode Default	: x	
Mode Messages	: x	
Mode Altered	: XXXXXXXXXXXXXXXXX	
Note Number : True voice	: 20 - 122 : XXXXXXXXXXXXXXXXX	
Velocity Note ON	: o 9nH,v=1-127	
Velocity Note OFF	: x 9nH,v=0	
After Touch Key's	: x	
After Touch Ch's	: o	: X1
Pitch Bender	: o	: 7 bit resolution
	2 : o X1	: Breath control
	7 : o X1	: Volume
Control Change		
Prog Change : True #	: o 0 - 4 : XXXXXXXXXXXXXXXXX	
System Exclusive	: x	
System : Song Pos	: x	
System : Song Sel	: x	
Common : Tune	: x	
System :Clock	: x	
Real Time :Commands	: x	
Aux :Local ON/OFF	: x	
Aux :All Notes OFF	: x	
Mes- :Active Sense	: o	
sages:Reset	: x	
Notes	: X1 = Select by DIP SW	

FINGERING CHARTS

The WX7's playing keys are arranged according to the standard Böhm fingering system. The fingering positions are shown in the following charts. The first chart gives

the positions for normally-pitched playing. The second chart offers four convenient methods of playing one octave above normal pitch.

TABLES DE DOIGTES

Les touches du WX7 son organisées en accord avec le système de doigté standard Böhm. Les positions de doigtés sont présentées dans les tables suivantes. La première table donne

les positions pour jouer sur une octave normale. Le deuxième table offre quatre méthodes commodes pour jouer une octave au dessus de la hauteur normale.

GRIFFTABELLEN

Die Anordnung der Fingertasten des WX7 entspricht dem Standard der Böhm-Grifftechnik. Die Griffpositionen werden in den folgenden Griff Tabellen gezeigt. Die erste

Tabelle enthält die Griffe für normales Spielen, die zweite zeigt Ihnen vier praktische Methoden, um eine Oktave über der normalen Tonhöhe zu spielen.

WX7 FINGERING CHART (NORMAL PITCH)

Shaded keys are fingered.

TABLE DE DOIGTE WX7 (HAUTEUR NORMALE)

Les touches en ombré sont jouées.

FINGERING-TABELLE FÜR WX7 (NORMALE TONLAGE)

Die schraffierten Tasten sind auf Fingered gestellt.

WX7 FINGERING CHART (OCTAVE TRANSPOSE)

Shaded keys are fingered.

TABLE DE DOIGTE WX7 (TRANSPPOSITION A L'OCTAVE)

Les touches en ombré sont jouées.

WX7 FINGERING CHART (OCTAVE TRANSPOSE)

Shaded keys are fingered.

Octave changes (from two octaves below concert pitch to three octaves above) can also be made using the Octave Transpose keys. Octave changes made with these keys are in addition to those made using the fingerings shown in the charts. Refer to the rear view illustration in the Guide to the Controls section for more about the Octave Transpose keys.

WX7 FINGERING CHART (OCTAVE TRANSPOSITION)

Die schraffierten Tasten sind auf Fingered gestellt.

Les changements d'octave (de 2 octaves au dessous du diapason de concert à 3 octaves au dessus) peuvent également être effectués en utilisant les touches de transposition d'octave. Les changements d'octave réalisés avec les touches s'ajoutent à ceux effectués par des doigts indiqués dans les tables. Reportez-vous à l'illustration de la vue arrière dans la section GUIDE DES COMMANDES pour plus de détails sur la touche de transposition d'octave.

* In this line, these keys have been released to transpose up by one octave.

* Dans cette ligne, ces touches ont été relâchées pour transposer d'une octave vers le haut.

* In dieser Linie wurden diese Tasten losgelassen, um um eine Oktave höher zu transponieren.

* The A# key is fingered.
La touche LA# est jouée.
Die Taste A# ist auf Fingered gestellt.

FINGERING-TABELLE FÜR WX7 (OKTAVEN-TRANSPONIERUNG)

Die schraffierten Tasten sind auf Fingered gestellt.

Änderungen der Oktavlage (von zwei Oktaven unter dem Kamerton bis zu drei Oktaven darüber) sind auch mit Hilfe der Oktaven-Transponiertasten möglich. Auf diese Weise vorgenommene Änderungen der Oktavlage erfolgen zusätzlich zu den Änderungen, die über die in der Griffabelle gezeigten Griffe auszuführen werden. Weitere Einzelheiten zu den Oktaven-Transponiertasten finden Sie in der Rückansicht des WX7 im Kapitel "BESCHREIBUNG DER BEDIENELEMENTE".

YAMAHA

YAMAHA CORPORATION
PO Box 1, Hamamatsu, Japan

VD89160 88 06 1.2 R6 CR Printed in Japan