



DME7

Remote Control Protocol Specifications

Version 1.1.0

This specification document applies to DME7 V1.1.0 and later.

Table of contents

0. Revision History	4
1. Setup	5
1.1. Connection Procedure	5
1.2. Configuring the Remote Controller	5
1.3. Device Configuration	5
2. Command List	6
2.1. Commands from a device sent to a remote controller	6
2.2. Commands for controlling a device	6
2.3. Extended commands	7
3. Command Specifications	8
3.1. Basic Command Specifications	8
3.2. Commands a Device Sends to a Remote Controller	9
3.2.1. Device status change notification	9
3.2.2. Parameter change notification	10
3.2.3. Meter information notification	10
3.2.4. Snapshot change notification	10
3.2.5. Event processing change notification	11
3.3. Commands for controlling a device	13
3.3.1. Device status query	13
3.3.2. Device run mode change	14
3.3.3. External control protocol run mode setting	14
3.3.4. Parameter query	16
3.3.5. Parameter setting	18
3.3.6. Meter control	22
3.3.7. Snapshot processing	23
3.4. Extended commands	24
3.4.1. Product information query request	24
3.4.2. Parameter information query request	28
3.4.3. Meter information query request	30
3.4.4. Snapshot information query request	31
3.4.5. Identify	32
3.4.6. Event processing request	32
3.4.7. List item processing	37
3.5. Command Errors	38
3.5.1. Command Error Notifications	38
4. Command Sequence	39
4.1. Communication start sequence	39
4.2. Information list query sequence	41
4.3. Parameter sync sequence	44
4.4. Parameter setting sequence by a user	46
4.5. Parameter query sequence at any given time	48
4.6. Meter data request/query sequence	48
4.7. Snapshot recall request sequence	49
4.8. Sequence when parameters are changed by another controller	49
5. Meter Value	50
5.1. Level Meter, Hold Meter, GR Meter	50

6. Parameter Value Details	51
6.1. Fader parameter	51
6.1.1. Fader with “-∞ to 0dB” range.....	51
6.1.2. Fader with “-∞ to 10dB” range.....	53
6.2. Other parameters.....	55
6.2.1. Ambient Noise Compensator	55
6.2.2. Auto Gain Control.....	55
6.2.3. Combiner.....	56
6.2.4. Dynamics	56
6.2.5. REV-X	58
6.2.6. EQ.....	59
6.2.7. Filter	60
6.2.8. Mixer	60
6.2.9. Oscillator	60
6.2.10. Standard SPP/C-Series SPP(FIR).....	61
7. Parameter List	62
7.1. Audio Component	62
7.2. Control Component.....	69
8. Meter List	70

0. Revision History

Version	Date	Section	Description
V1.0.0	Jan. 18, 2023	–	Initial version
V1.1.0	Jan. 25, 2024	3.2.5, 3.4.6	Added Audio Player related commands
		3.4.6, 3.4.7	Added Scheduler related commands
		3.4.6	Added command that specifies the display font
		7.1	Added De-Esser, Program Ducker, and Ping Pong Delay to the Audio Component
		8	Added De-Esser and Program Ducker

1. Setup

1.1. Connection Procedure

Connection when using the NETWORK connector to perform remote control using this protocol

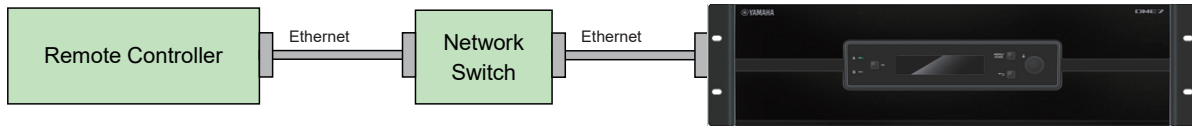

1.2. Configuring the Remote Controller

DME7 can be controlled from an external controller through the Ethernet (NETWORK) connector.

IP Address: Specify the IP address of the device to be controlled.

IP Port No.: 49280

DME7 can be controlled from an external controller through the NETWORK Port connection.

Up to eight remote controller devices can connect simultaneously to one DME7.

1.3. Device Configuration

Remote Parameter control for DME7 is managed via the Remote Control Setup List. This list must first be created in ProVisionaire Design in order to specify which Parameters and meters can be controlled from an external remote controller. This list will be uploaded to DME7 during Synchronisation.

2. Command List

2.1. Commands from a device sent to a remote controller

No.	Notification details		Reply from device	Remarks
1-1	Device status change notification	Device run mode notification	NOTIFY devstatus runmode ...	
1-2		Device error status notification	NOTIFY devstatus error ...	
1-3		Power supply unit status notification	NOTIFY devstatus power1 ... NOTIFY devstatus power2 ...	
1-4	Parameter change notification	Parameter change notification raw value	NOTIFY set ...	
		Parameter change notification normalized value	NOTIFY setn ...	
1-5	Meter information notification	Meter information notification	NOTIFY mtr ...	
1-6	Snapshot change notification	Snapshot number change notification	NOTIFY sscurrent_ex ...	
1-7		Snapshot recall start notification	NOTIFY ssrecall_ex ...	
1-8	Event processing change notification	ProVisionaire Design synchronization processing notification	NOTIFY event PROC:SynchronizationSetStatus...	
1-9		Media insertion notification	NOTIFY event PROC:Media ...	
1-10		Playback type change notification	NOTIFY event PROC:AudioPlayerSetType...	
1-11		Song/folder path change notification	NOTIFY event PROC:AudioPlayerSetPath...	
1-12		Song playback mode change notification	NOTIFY event PROC:AudioPlayerSetPlayMode...	
1-13		GoToTheTop change notification	NOTIFY event PROC:AudioPlayerSetGoToTheTop...	
1-14		Song interval change notification	NOTIFY event PROC:AudioPlayerSetInterval...	
1-15		Play, stop, and other transport operation notification	NOTIFY event PROC:AudioPlayerTransport...	
1-16		Playback song notification	NOTIFY event PROC:AudioPlayerSetCurrentSong...	

2.2. Commands for controlling a device

No.	Notification details		Reply from device	Remarks
2-1	Device status query	Device run mode query	devstatus runmode	
2-2		Device error status query	devstatus error	
2-3		Power supply unit status query	devstatus power1 devstatus power2	
2-4	Device run mode change	Device run mode change	devmode normal devmode emergency	
2-5	DME7 external control protocol run mode setting	Result and change notification character encoding setting	scpmode encoding...	
2-6		Value notification mode setting	scpmode valuetype...	
2-7		Normalization resolution setting	scpmode resolution...	
2-8		Keepalive activation setting	scpmode keepalive...	
2-9	Parameter query	Raw value parameter query	get...	
2-10		Normalized value parameter query (*)	getn...	
2-11		String parameter query (*)	gett...	
2-12	Parameter setting	Raw value parameter setting	set...	
2-13		Normalized value parameter setting	setn...	
2-14		Parameter setting by string	sett...	
2-15		Relative value parameter setting (INC/DEC level control)	setr...	
2-16	Meter control	Transmission request	mtrstart ...	
2-17		Stop request	mtrstop ...	
2-18	Snapshot processing	Current snapshot number query	sscurren_ex	
2-19		Snapshot recall processing	ssrecall_ex ...	

* When value is set "1023" (default:1000), control resolution becomes the same as "Raw value" command. See "6.1. Fader parameter" for the "Normalized value" vs "Raw value" when the value is set "1023".

2.3. Extended commands

No.	Notification details	Reply from device	Remarks
3-1	Product information query request	Protocol version query	devinfo protocolver ...
3-2		Parameter set version query	devinfo paramsetver...
3-3		Firmware version query	devinfo version ...
3-4		Product name query	devinfo productname ...
3-5		Product manufacture name query	devinfo manufacturer ...
3-6		Serial number query	devinfo serialno ...
3-7		Device category query	devinfo category ...
3-8		Device ID query	devinfo deviceid ...
3-9		Device name query	devinfo devicename...
3-10		Audio input port number query	devinfo inputport ...
3-11		Audio output port query	devinfo outputport ...
3-12		GPI IN port number query	devinfo gpi ...
3-13		GPI OUT port number query	devinfo gpo ...
3-14	Parameter information query request	Parameter number query	prmnum ...
3-15		Nth parameter information query	prminfo ...
3-16	Meter information query request	Meter number query	mtrnum ...
3-17		Nth meter information query	mtrinfo ...
3-18	Snapshot information query request	Snapshot number query	ssnum_ex ...
3-19		Snapshot information query	ssinfo_ex ...
3-20	Identify	Identify	identify
3-21	Event processing request	Playback type setting	event PROC:AudioPlayerSetType...
3-22		Song/folder path setting	event PROC:AudioPlayerSetPath...
3-23		Song playback mode setting	event PROC:AudioPlayerSetPlayMode...
3-24		GoToTheTop setting	event PROC:AudioPlayerSetGoToTheTop...
3-25		Song interval setting	event PROC:AudioPlayerSetInterval...
3-26		Song playback status query	event PROC:AudioPlayerGetStatus...
3-27		Play, stop, and other transport operation	event PROC:AudioPlayerTransport...
3-28		Currently playing or selected song information query	event PROC:AudioPlayerGetCurrentSong...
3-29		Playback song designation	event PROC:AudioPlayerSetCurrentSong...
3-30		Display font designation	event PROC:Language...
3-31		Scheduler event enable/disable setting	event PROC:SchedulerSetEnable...
3-32		Scheduler event time setting	event PROC:SchedulerSetTime...
3-33	List item processing	AudioPlayer item number query	listitemnum PROC:AudioPlayer
3-34		AudioPlayer item information query	listitem PROC:AudioPlayer...
3-35		Scheduler event number query	listitemnum PROC:Scheduler
3-36		Scheduler event information query	listitem PROC:Scheduler...

3. Command Specifications

3.1. Basic Command Specifications

Below is the syntax of commands exchanged between a device and remote controller.

<command name> <option 1> <option 2> . . . <option n> <new line>

- Each command must end with LF (0x0A).
- LF (0x0A) code can be sent as heart-beat command. Refer to "2-8). Keepalive activation setting" for details.
- Character type letter(s) in command line must be bracketed by double quotations. When double quotation itself needs to be included in command line, use "escape character" as shown below.

Backslash works as an escape character to express following one character for double quotation and backslash.

Syntax	Meaning	Description
\\	\	backslash
\"	"	double quotation

- At least one space is necessary between a command name and an option and between options.
- Commands must be expressed using ASCII characters. Other characters are not allowed.
- Option strings that express parameter values are shown below.

Value	Displayed string	Raw Value	Normalized Value
-Infinity	"-∞"	-13801	0
-18dB	"-18.00"	-1800	453
-6.5dB	"-6.50"	-650	677
0dB	"0.00"	0	804
10dB	"10.00"	1000	1000
2kHz	"2.00k"	2000000	667
400Hz	"400"	400000	435
Pan L 63	"L63"	-63	0
Pan Center	"C"	0	500
Pan R 63	"R63"	+63	1000
ON	"ON"	0	500
		1	1000
OFF	"OFF"	0	0
		1	1000
INVERTED	"INVERTED"	1	1000
NORMAL	"NORMAL"	0	0

* For other parameters, see section 6, "Parameter Value Details", provided later.

* Normalized value is a converted value when minimum parameter value is as 0 and maximum value of the parameter is as 1000¹.

Example: -inf as minimum mapped 0, 10dB as maximum mapped 1000, 0dB mapped 804 for level parameter.

* 1: This value is set by "2-7). Normalization resolution setting", default resolution is 1000.

How to interpret meter values

A single meter data is expressed with stringed 2-digit hexadecimal. When there are multiple data, they are notified with a string divided by a single space. And if the meter data is interrupted in the middle, the interpreted data are considered valid, and the data afterward is regarded as no data.

Command example: NOTIFY mtr PROC:Remote/2/In>level 71 71 71 71 71 71 69 68

3.2. Commands a Device Sends to a Remote Controller

3.2.1. Device status change notification

1-1) Device run mode notification

Command	Option 1	Option 2	Description
NOTIFY devstatus	runmode	"normal"	Normal run mode, commands can be received.
		"emergency"	Emergency run mode, commands can be received.
		"booting"	Device booting, commands cannot be received.
		"update"	Update mode, commands cannot be received.

Example: Notification: NOTIFY devstatus runmode "normal"
 Meaning: The run mode was changed to normal mode.

1-2) Device error status notification

Command	Option 1	Option 2	Description
NOTIFY devstatus	error	"flt/xxxx"	Alert fault information
		"err/xxxx"	Alert error information
		"wrn/xxxx"	Alert warning information

Details:

- "flt/xxxx" = "**flt**/message// xnnn onf (sssss) **ID**-xxx 2012/12/31 23:59:59"
- "err/xxxx" = "**err**/message// xnnn onf (sssss) **ID**-xxx 2012/12/31 23:59:59"
- "wrn/xxxx" = "**wrn**/message// xnnn onf (sssss) **ID**-xxx 2012/12/31 23:59:59"

The first three characters indicate the alert type.

message = Alert message (The section from "/" to "/" after the alert type is the message data.)
 . . . up to 32 characters (ascii characters)

nnn = Alert number (panel display number)
 . . . 2 or 3 digit hexadecimal notation (The x at the front indicates hexadecimal notation.)

onf = Alert on/off
 . . . Persistent alerts turn on when an alert condition occurs and turn off when they are cleared.
 Single-shot alerts turn on while an alert condition is true.

sssss = Identical alert count (a counter that indicates the number of identical alerts, normally set to 1)
 . . . Decimal notation

xxx = UNIT ID number . . . 3-digit hexadecimal

Date
 Time

Example: Notification: NOTIFY devstatus error "err/DCP[0] communication error// x53 on (1) ID-001 2013/1/22 11:38:23"
 Meaning: Error alert 53 occurred.

1-3) Power supply unit status notification

Command	Option 1	Option 2	Description
NOTIFY devstatus	power1	"fine"	Status of power supply unit (A). The device is running normally.
		"down"	The device went down.
	power2	"fine"	Status of power supply unit (B) The device is running normally.
		"down"	The device went down.

Example: Notification: NOTIFY devstatus power1 "fine"
 Meaning: The power supply unit (A) is running normally.

3.2.2. Parameter change notification

1-4) Parameter change notification raw value Parameter change notification normalized value

Command	Option 1	Option 2	Option 3	Option 4	Option 5	Description
NOTIFY set	PROC:Remote/ IndexNo	X	Y	"(value)"	"(string)"	Parameter change, raw value
NOTIFY setn	PROC:Remote/ IndexNo	X	Y	"(value)"	"(string)"	Parameter change, normalized value

Details: **IndexNo** = Index number assigned in Remote Control Setup List
 X = See "3.3.4. Parameter query".
 Y = See "3.3.4. Parameter query".
 "(value)" = See "3.1. Basic Command Specifications" and/or "7. Parameter List".
 "(string)" = See "3.1. Basic Command Specifications" and/or "7. Parameter List".

Example: Notification: NOTIFY set PROC:Remote/3 0 0 -7760 "-77.60"
 Meaning: Level of the parameter assigned to Index 3 in Remote Control List was changed to "-77.60".

Important: If the same parameter is assigned to multiple Index numbers in the Remote Control Setup List, notification is only provided to the lowest assigned Index number.

3.2.3. Meter information notification

1-5) Meter information notification

Command	Option 1	Option 2	Option 3	Description
NOTIFY mtr	PROC:Remote/ IndexNo	"(type)"	(meter)	Level meter value
NOTIFY mtr	PROC:Remote/ IndexNo>PeakHold	"(type)"	(meter)	Peak hold meter value

Details: **IndexNo** = Index number assigned in Remote Control Setup List
 "(type)" = Meter type. See "Type" in "8. Meter List".
 (meter) = See "5. Meter Value".

Example: Notification: NOTIFY mtr PROC:Remote/2 level 71 71 71 71 71 71 69 68
 * The meter value is expressed using a 2-digit hexadecimal.
 Meaning: The meter type and the level meter value which are assigned to Index 2 in Remote Control list are sent.
 In the example, the meter type and the value for CH 1 to 8 are sent.

Example: Notification: NOTIFY mtr PROC:Remote/2>PeakHold level 71 71 71 71 71 71 69 68
 * The meter value is expressed using a 2-digit hexadecimal.
 Meaning: The meter type and the peak hold value which are assigned to Index 2 in Remote Control list are sent.
 In the example, the meter type and the value for CH 1 to 8 are sent.

3.2.4. Snapshot change notification

1-6) Snapshot number change notification

Command	Option 1	Option 2	Description
NOTIFY sscurrent_ex	(id)	(index)	Current snapshot number change notification

Details: **(id)** = Parameter set ID
 (index) = Snapshot number

Example: Notification: NOTIFY sscurrent_ex 5000 10
 Meaning: Snapshot 10 of the parameter set ID 5000 was recalled.

Important: If the parameters assigned in Remote Control Setup List are assigned as a parameter set and the snapshot is recalled, the change made for the parameters is not sent. To confirm the change, query the parameter value.

1-7) Snapshot recall start notification

Command	Option 1	Option 2	Description
NOTIFY ssrecall_ex	(id)	(index)	Snapshot recall start notification

Details: **(id)** = Parameter set ID
(index) = Snapshot number

Example: Notification: NOTIFY sscurrent_ex 5000 10
Meaning: Recall process for snapshot 10 of the parameter set ID 5000 started.

Important: If the parameters assigned in Remote Control Setup List are assigned as a parameter set and the snapshot is recalled, the change made for the parameters is not sent. To confirm the change, query the parameter value.

3.2.5. Event processing change notification**1-8) ProVisionaire Design synchronization processing notification**

Command	Option 1	Option 2	Description
NOTIFY event	PROC:SynchronizationSetStatus	"active"	Synchronization starts
		"inactive"	Synchronization ends

Example: Notification: NOTIFY event PROC:SynchronizationSetStatus "active"
Meaning: Synchronization process between DME7 and ProVisionaire Design started.

Important: When this notification is received, because the internal DME7 settings may have changed significantly, we recommend that you verify the connection by querying relevant parameters.

1-9) Media insertion notification

Command	Option 1	Option 2	Description
NOTIFY event	PROC:Media	"sdcard=inserted"	An SD memory card was inserted.
		"sdcard=extracted"	An SD memory card was removed.

Example: Notification: NOTIFY event PROC:Media "sdcard=inserted"
Meaning: An SD memory card was inserted into an SD memory card slot and was detected normally.

1-10) Playback type change notification

Command	Option 1	Option 2	Option 3	Description
NOTIFY event	PROC:AudioPlayerSetType	"index=xxxx"	"type=yyyy"	Playback type change notification

Details: xxxx = Index
 yyyy = noAssign, 1song, folder

Example: Notification: NOTIFY event PROC:AudioPlayerSetType "index=1" "type=1song"
Meaning: The playback type was changed to "song".

Reference: listitemnum, listitem

1-11) Song/folder path change notification

Command	Option 1	Option 2	Option 3	Description
NOTIFY event	PROC:AudioPlayerSetPath	"index=xxxx"	"path=yyyy"	Song/folder path change notification

Details: xxxx = Index
 yyyy = Path of the song or folder

Example: Notification: NOTIFY event PROC:AudioPlayerSetPath "index=1" "path=song.wav"
Meaning: The path was changed to song.wav.

Reference: listitemnum, listitem

1-12) Song playback mode change notification

Command	Option 1	Option 2	Option 3	Description
NOTIFY event	PROC:AudioPlayerSetPlayMode	"index=xxxx"	"mode=yyyy"	Song playback mode change notification

Details: xxxx = Index
 yyyy = normal, repeat, shuffleRepeat

Example: Notification: NOTIFY event PROC:AudioPlayerSetPlayMode "index=1" "mode=normal"
 Meaning: The playback mode was changed to "normal".

Reference: listitemnum, listitem

1-13) GoToTheTop change notification

Command	Option 1	Option 2	Option 3	Description
NOTIFY event	PROC:AudioPlayerSetGoToTheTop	"index=xxxx"	"goToTheTop=yyyy"	GoToTheTop change notification

Details: xxxx = Index
 yyyy = off, on

Example: Notification: NOTIFY event PROC:AudioPlayerSetGoToTheTop "index=1" "goToTheTop=off"
 Meaning: The Go To The Top setting was changed to off.

Reference: listitemnum, listitem

1-14) Song interval change notification

Command	Option 1	Option 2	Option 3	Description
NOTIFY event	PROC:AudioPlayerSetInterval	"index=xxxx"	"interval=yyyy"	Song interval change notification

Details: xxxx = Index
 yyyy = Interval value

Example: Notification: NOTIFY event PROC:AudioPlayerSetInterval "index=1" "interval=3.0"
 Meaning: The interval was set to 3.0 seconds.

Reference: listitemnum, listitem

1-15) Play, stop, and other transport operation notification

Command	Option 1	Option 2	Description
NOTIFY event	PROC:AudioPlayerTransport	"operation=stop"	Stop
		"operation=play"	Play
		"operation=pause"	Pause

Example: Notification: NOTIFY event PROC:AudioPlayerTransport "operation=stop"
 Meaning: Playback was stopped.

1-16) Playback song notification

Command	Option 1	Option 2	Description
NOTIFY event	PROC:AudioPlayerSetCurrentSong	"index=xxxx"	Playback song designation

Details: xxxx = Index

Example: Notification: NOTIFY event PROC:AudioPlayerSetCurrentSong "index=1"
 Meaning: The playback song was set to index number 1.

Reference: listitemnum, listitem

3.3. Commands for controlling a device

3.3.1. Device status query

2-1) Device run mode query

Command	Option 1	Description
devstatus	runmode	Queries the run mode

Response

Response string	Description
OK devstatus runmode "normal"	Normal run mode, commands can be received.
OK devstatus runmode "emergency"	Emergency run mode, commands can be received.
OK devstatus runmode "booting"	Device starting, commands cannot be received.
OK devstatus runmode "update"	Update mode, commands cannot be received.

Example: Command: devstatus runmode
 Response: OK devstatus runmode "normal"
 Meaning: Query the run mode.
 The device is currently in normal run mode.

Note: After device responds with -OK devstatus runmode "normal"-, device starts to send commands. In order to establish remote control communication, the external controller must send [devstatus runmode] command to the device and await response. When the device responds as [OK devstatus runmode "normal"], the device is ready to receive commands.

2-2) Device error status query

Command	Option 1	Description
devstatus	error	Queries the error status

Response

Response string	Description
OK devstatus error "none"	No alerts
OK devstatus error "flt/xxxx"	Fault alert
OK devstatus error "err/xxxx"	Error alert
OK devstatus error "wrn/xxxx"	Warning alert

Details: "flt/ xxxx" = "**flt**/message// xnnn onf (sssss) **ID-xxx** 2012/12/31 23:59:59"
 "err/ xxxx" = "**err**/message// xnnn onf (sssss) **ID-xxx** 2012/12/31 23:59:59"
 "wrn/ xxxx" = "**wrn**/message// xnnn onf (sssss) **ID-xxx** 2012/12/31 23:59:59"
 The first three characters indicate the alert type.
 message = Alert message (The section from "/" to "/" after the alert type is the message data.)
 ... up to 32 characters (ascii characters)
 nnn = Alert number (panel display number)
 ... 2 or 3 digit hexadecimal notation (The x at the front indicates hexadecimal notation.)
 onf = Alert on/off
 ... Persistent alerts turn on when an alert condition occurs and turn off when they are cleared.
 Momentary event sends only ON when it happens.
 sssss = Identical alert count (a counter that indicates the number of identical alerts, normally set to 1)
 ... Decimal notation
 xxx = UNIT ID number ... 3- digit hexadecimal
 Date
 Time

Example: Command: devstatus error
 Response: OK devstatus error "err/DCP[0] communication error// x53 on (1) ID-001 2013/1/22 11:38:23"
 Meaning: Query the alert status.
 Error alert 53 is occurring.

2-3) Power supply unit status query

Command	Option 1	Description
devstatus	Power1	Status of power supply unit (A)
	Power2	Status of power supply unit (B)

Response

Response string	Description
OK devstatus Power1 "fine"	The device is running normally.
OK devstatus Power1 "down"	The device went down.
OK devstatus Power2 "fine"	The device is running normally.
OK devstatus Power2 "down"	The device went down.

3.3.2. Device run mode change**2-4) Device run mode change**

Command	Option 1	Description
devmode	normal	Sets the run mode to normal
	emergency	Sets the run mode to emergency

Response

Response string	Description
OK devmode normal	Normal run mode change complete
OK devmode emergency	Emergency run mode change complete

Example: Command: devmode emergency
 Response: OK devmode emergency
 Meaning: Change to emergency mode.
 Run mode was changed to emergency.

3.3.3. External control protocol run mode setting**2-5) Result and change notification character encoding setting**

Command	Option 1	Option 2	Description
scpmode	encoding	ascii	ASCII encoding mode (default setting)
		utf8	UTF-8 encoding mode

Response

Response string	Description
OK scpmode encoding ascii	ASCII encoding mode change complete
OK scpmode encoding utf8	UTF-8 encoding mode change complete

Example: Command: scpmode encoding utf8
 Response: OK scpmode encoding utf8
 Meaning: Change the result and change notification encoding mode to UTF-8.
 The encoding mode was changed to UTF-8.

Important: When ASCII is selected, all the character codes out of the range are replaced and notified with "?".

2-6) Value notification mode setting

Command	Option 1	Option 2	Description
scpmode	valuetype	raw	Raw value mode (default setting)
		normalized	Normalized value mode

Response

Response string	Description
OK scpmode valuetype raw	Raw value mode change complete
OK scpmode valuetype normalized	Normalized value mode change complete

Example: Command: scpmode valuetype normalized
 Response: OK scpmode valuetype normalized
 Meaning: Change parameter change notifications to normalized value mode.
 Parameter change notifications were changed to normalized value mode.

2-7) Normalization resolution setting

Command	Option 1	Option 2	Description
scpmode	resolution	(res)	Resolution for normalized value notifications (default setting = 1000)

Details: (res) = Resolution for normalized values

Response

Response string	Description
OK scpmode resolution xxxx	The resolution for normalized value notifications

Details: xxxx = Specified resolution * Specified resolution should be more than 100.

Example: Command: scpmode resolution 128
 Response: OK scpmode resolution 128
 Meaning: Set the resolution of normalized values for setn commands to 128.
 The resolution of normalized values for setn commands was set to 128.

2-8) Keepalive activation setting

Command	Option 1	Option 2	Description
scpmode	keepalive	(interval)	Maximum interval for a client to send some kind of message, including heart beats (default setting = disabled)

Details: (interval) = Timeout value (msec) * Timeout value should be more than 1000.
 * The actual timeout value will be increased by 1 second.

Response

Response string	Description
OK scpmode keepalive xxxx	Keepalive activated notification

Details: xxxx = The specified timeout value (msec)

Example: Command: scpmode keepalive 2000
 Response: OK scpmode keepalive 2000
 Meaning: Set the timeout value to 2000 msec (2 seconds).
 The timeout value was set to 2000 msec (2 seconds).

Note: When unexpected disconnection happens, remote controller can't finish communication with closing process. In such case, device has to keep status "connected" and remote controller can't establish new connection after that.

In order to prevent the situation above, device watches keepalive command if connection with remote controller is still alive. If device doesn't receive keepalive command within timeout value which is set by this command, device terminates connection by itself.

After the Keepalive activation command has been activated, the Remote controller must send any command or LF(0x0A) code as a heart beat to the device within the timeout value.

3.3.4. Parameter query

2-9) Raw value parameter query

Command	Option 1	Option 2	Option 3	Description
get	PROC:Remote/IndexNo	X	Y	Raw value parameter query request

Details: **IndexNo** = Index number assigned in Remote Control Setup List
X = Specify the channel, etc. See the Remote Control Setup List that the target parameter is assigned to.
Y = Specify the channel, etc. See the Remote Control Setup List that the target parameter is assigned to.
Parameters assigned by specifying X and Y in the Remote Control Setup List require X and Y designation but become invalid.
“0” is recommended.
Parameters assigned by specifying X and Y as “any” in the Remote Control Setup List require X and Y designation.
Both X and Y can be registered as “any”.

When “all” is assigned to X, all parameters corresponding to Y can be obtained.
When “all” is assigned to Y, all parameters corresponding to X can be obtained.
However, “all” cannot be assigned to both X and Y simultaneously.

Response

Response string	Description
OK get PROC:Remote/IndexNo X Y (value)	Raw value parameter query response

Details: **(value)** = See “3.1. Basic Command Specifications” and/or “7. Parameter List”.

Example: If the Ch 2 level of the Fader component (4 ch) is assigned to Index 1 in Remote Control Setup List

Command: get PROC:Remote/1 0 0

Response: OK get PROC:Remote/1 0 0 -7760

Meaning: Query the parameter assigned to index 1 in Remote Control Setup List with raw values.
The parameter assigned to Index 1 in Remote Control Setup List is -77.60.

Command: get PROC:Remote/1 all 0

Response: OK get PROC:Remote/1 all 0 -7760

Meaning: Query all parameters assigned to index 1 in Remote Control Setup List with raw values.
The parameter assigned to Index 1 in Remote Control Setup List is -77.60.

* Even if “all” is assigned, the response will contain only one parameter because the fixed channel is assigned.

Example: If the level of the Fader component (4 ch) is assigned as “any” to Index 1 in Remote Control Setup List

Command: get PROC:Remote/1 2 0

Response: OK get PROC:Remote/1 2 0 -7760

Meaning: Query 3 ch of the parameter assigned to index 1 in Remote Control Setup List with raw values.
The Parameter assigned to Index 1 in Remote Control Setup List is -77.60.

Command: get PROC:Remote/1 all 0

Response: OK get PROC:Remote/1 all 0 -5000 -6000 -7000 -7760

Meaning: Query all parameters assigned to index 1 in Remote Control Setup List with raw values.
The parameters assigned to Index 1 in Remote Control Setup List are -50.00, -60.00, -70.00, -77.60.

2-10) Normalized value parameter query

Command	Option 1	Option 2	Option 3	Description
getn	PROC:Remote/IndexNo	X	Y	Normalized value parameter query request

Details: **IndexNo** = Index number assigned in Remote Control Setup List
X = Specify the channel, etc. See the Remote Control Setup List that the target parameter is assigned to.
Y = Specify the channel, etc. See the Remote Control Setup List that the target parameter is assigned to.
Parameters assigned by specifying X and Y in the Remote Control Setup List require X and Y designation but become invalid.
"0" is recommended.
Parameters assigned by specifying X and Y as "any" in the Remote Control Setup List require X and Y designation.
Both X and Y can be registered as "any".

When "all" is assigned to X, all parameters corresponding to Y can be obtained.
When "all" is assigned to Y, all parameters corresponding to X can be obtained.
However, "all" cannot be assigned to both X and Y simultaneously.

Response

Response string	Description
OK getn PROC:Remote/IndexNo X Y (value)	Normalized value parameter query response

Details: **(value)** = See "3.1. Basic Command Specifications" and/or "7. Parameter List".

Example: If the Ch 2 level of the Fader component (4 ch) is assigned to Index 1 in Remote Control Setup List

Command: getn PROC:Remote/1 0 0

Response: OK getn PROC:Remote/1 0 0 408

Meaning: Query the parameter assigned to index 1 in Remote Control Setup List with normalized values.
The Parameter assigned to Index 1 in Remote Control Setup List is 408.

See "get" for other examples.

2-11) String parameter query

Command	Option 1	Option 2	Option 3	Description
gett	PROC:Remote/IndexNo	X	Y	String parameter query request

Details: **IndexNo** = Index number assigned in Remote Control Setup List
X = Specify the channel, etc. See the Remote Control Setup List that the target parameter is assigned to.
Y = Specify the channel, etc. See the Remote Control Setup List that the target parameter is assigned to.
Parameters assigned by specifying X and Y in the Remote Control Setup List require X and Y designation but become invalid.
"0" is recommended.
Parameters assigned by specifying X and Y as "any" in the Remote Control Setup List require X and Y designation.
Both X and Y can be registered as "any".

When "all" is assigned to X, all parameters corresponding to Y can be obtained.
When "all" is assigned to Y, all parameters corresponding to X can be obtained.
However, "all" cannot be assigned to both X and Y simultaneously.

Response

Response string	Description
OK gett PROC:Remote/IndexNo X Y "(string)"	String parameter query response

Details: **(string)** = Display string. See "3.1. Basic Command Specifications" and/or "7. Parameter List".

Example: If the Ch 2 level of the Fader component (4 ch) is assigned to Index 1 in Remote Control Setup List

Command: gett PROC:Remote/1 0 0

Response: OK gett PROC:Remote/1 0 0 "10.0"

Meaning: Query the parameter value assigned to index 1 in Remote Control Setup List with strings.
The string of the parameter value assigned to Index 1 in Remote Control Setup List is "10.0".

See "get" for other examples.

3.3.5. Parameter setting

2-12) Raw value parameter setting

Command	Option 1	Option 2	Option 3	Option 4	Description
set	PROC:Remote/IndexNo	X	Y	(value)	Raw value parameter setting

Details: **IndexNo** = Index number assigned in Remote Control Setup List
X = Specify the channel, etc. See the Remote Control Setup List that the target parameter is assigned to.
Y = Specify the channel, etc. See the Remote Control Setup List that the target parameter is assigned to.
Parameters assigned by specifying X and Y in the Remote Control Setup List require X and Y designation but become invalid.
"0" is recommended.
Parameters assigned by specifying X and Y as "any" in the Remote Control Setup List require X and Y designation.
X and Y can be registered as "any" at the same time.
(value) = Parameter's raw value. See "3.1. Basic Command Specifications" and/or "7. Parameter List".

Response

Response string	Description
OK set PROC:Remote/IndexNo X Y (value) "(string)"	Raw value parameter setting response
OKm set PROC:Remote/IndexNo X Y (value) "(string)"	

* If the requested parameter value is outside the range, the value is adjusted within the range and set.
If this occurs, the result notification will be OKm instead of OK.

Details: **"(string)"** = Display string. See "3.1. Basic Command Specifications" and/or "7. Parameter List".

Example: If the Ch 2 level of the Fader component (4 ch) is assigned to Index 1 in Remote Control Setup List

Command: set PROC:Remote/1 0 0 -7760

Response: OK set PROC:Remote/1 0 0 -7760 "-77.60"

Meaning: Set the parameter assigned to index 1 in Remote Control Setup List to -77.60 using raw values.
The parameter assigned to index 1 in Remote Control Setup List was set to "-77.60".

Example: If the level of the Fader component (4 ch) is assigned as "any" to Index 1 in Remote Control Setup List

Command: set PROC:Remote/1 2 0 -7760

Response: OK set PROC:Remote/1 2 0 -7760 "-77.60"

Meaning: Set Ch 3 of the parameter assigned to index 1 in Remote Control Setup List to -77.60 using raw values.
Ch 3 of the parameter assigned to index 1 in Remote Control Setup List was set to "-77.60".

2-13) Normalized value parameter setting

Command	Option 1	Option 2	Option 3	Option 4	Description
setn	PROC:Remote/IndexNo	X	Y	(value)	Normalized value parameter setting

Details: **IndexNo** = Index number assigned in Remote Control Setup List
X = Specify the channel, etc. See the Remote Control Setup List that the target parameter is assigned to.
Y = Specify the channel, etc. See the Remote Control Setup List that the target parameter is assigned to.
Parameters assigned by specifying X and Y in the Remote Control Setup List require X and Y designation but become invalid.
"0" is recommended.
Parameters assigned by specifying X and Y as "any" in the Remote Control Setup List require X and Y designation.
X and Y can be registered as "any" at the same time.
(value) = See "3.1. Basic Command Specifications" and/or "7. Parameter List". (*)

* When value is set to "1023" (default:1000), control resolution becomes same as "Raw value" command.
See "6.1. Fader parameter" for the "Normalized value" vs "Raw value"

Response

Response string	Description
OK setn PROC:Remote/IndexNo X Y (value) "(string)"	Normalized value parameter setting response
OKm setn PROC:Remote/IndexNo X Y (value) "(string)"	

* If the requested parameter value is outside the range, the value is adjusted within the range and set.
If this occurs, the result notification will be OKm instead of OK.

Details: **"(string)"** = Display string. See "3.1. Basic Command Specifications" and/or "7. Parameter List".

Example: If the Ch 2 level of the Fader component (4 ch) is assigned to Index 1 in Remote Control Setup List
Command: setn PROC:Remote/1 0 0 408
Response: OKm setn PROC:Remote/1 0 0 408 "-21.50"
Meaning: Set the parameter assigned to index 1 in Remote Control Setup List to 408 using normalized values.
The parameter assigned to index 1 in Remote Control Setup List was set to "-21.50".

Example: If the level of the Fader component (4 ch) is assigned as "any" to Index 1 in Remote Control Setup List
Command: setn PROC:Remote/1 2 0 408
Response: OKm setn PROC:Remote/1 2 0 408 "-21.50"
Meaning: Set ch 3 of the parameter assigned to index 1 in Remote Control Setup List to 408 using normalized values.
Ch 3 of the parameter assigned to index 1 in Remote Control Setup List was set to "-21.50".

2-14) Parameter setting by string

Command	Option 1	Option 2	Option 3	Option 4	Description
sett	PROC:Remote/IndexNo	X	Y	“(text)”	Parameter setting by string

Details: **IndexNo** = Index number assigned in Remote Control Setup List
X = Specify the channel, etc. See the Remote Control Setup List that the target parameter is assigned to.
Y = Specify the channel, etc. See the Remote Control Setup List that the target parameter is assigned to.
Parameters assigned by specifying X and Y in the Remote Control Setup List require X and Y designation but become invalid.
“0” is recommended.
Parameters assigned by specifying X and Y as “any” in the Remote Control Setup List require X and Y designation.
Both X and Y can be registered as “any”.
(text) = A string that indicates the parameter. Inf is interpreted as “-inf”.

Response

Response string	Description
OK sett PROC:Remote/IndexNo X Y “(string)”	Parameter setting response by string
OKm sett PROC:Remote/IndexNo X Y “(string)”	

* If the requested parameter value is outside the range, the value is adjusted within the range and set.
If this occurs, the result notification will be OKm instead of OK.
* Other parameters changed because of parameter links are separately sent by the Notify set or NOTIFY setn command.

Details: **“(string)”** = Display string. See “3.1. Basic Command Specifications” and/or “7. Parameter List”.

Example: If the Ch 2 level of the Fader component (4 ch) is assigned to Index 1 in Remote Control Setup List

Command: sett PROC:Remote/1 0 0 “10.0”

Response: OK sett PROC:Remote/1 0 0 “10.0”

Meaning: Set the parameter assigned to index 1 in Remote Control Setup List to “10.0” with strings.

Ch 11 of the parameter assigned to index 1 in Remote Control Setup List was set to “10.0” using display string values.

Example: If the level of the Fader component (4 ch) is assigned as “any” to Index 1 in Remote Control Setup List

Command: sett PROC:Remote/1 2 0 “10.0”

Response: OK sett PROC:Remote/1 2 0 “10.0”

Meaning: Set Ch 3 of the parameter assigned to index 1 in Remote Control Setup List to “10.0” with strings.

Ch 3 of the parameter assigned to index 1 in Remote Control Setup List was set to “10.0” using display string values.

2-15) Relative value parameter setting

Command	Option 1	Option 2	Option 3	Option 4	Description
setr	PROC:Remote/IndexNo	X	Y	“(value)”	Relative value parameter setting

Details: **IndexNo** = Index number assigned in Remote Control Setup List
X = Specify the channel, etc. See the Remote Control Setup List that the target parameter is assigned to.
Y = Specify the channel, etc. See the Remote Control Setup List that the target parameter is assigned to.
Parameters assigned by specifying X and Y in the Remote Control Setup List require X and Y designation but become invalid.
“0” is recommended.
Parameters assigned by specifying X and Y as “any” in the Remote Control Setup List require X and Y designation.
X and Y can be registered as “any” at the same time.
(value) = The number of steps, (See “Value” in “6.1. Fader parameter” of “6. Parameter Value Details”).

Important: This command is available only for fader type parameters.
See the “setr” column in section “7. Parameter List”, for information regarding which parameters support this command.

Response

Response string	Description
OK PROC:Remote/IndexNo X Y (value)	Relative value set command response.
OKm setrPROC:Remote/IndexNo X Y (value)	

* If the requested parameter value is outside the range, the value is adjusted within the range and set.
If this occurs, the result notification will be OKm instead of OK.

Details: **IndexNo** = Index number assigned in Remote Control Setup List
(value) = Setting value (See “Data” in “6.1. Fader parameter” of “6. Parameter Value Details”).

Example: If the Ch 2 level of the Fader component (4 ch) is assigned to Index 1 in Remote Control Setup List
Command: setr PROC:Remote/1 0 0 100
Response: OK setr PROC:Remote/1 0 0 -1900
Meaning: Set the parameter assigned to index 1 in Remote Control Setup List to 100 step increase.
The parameter which is assigned to index 1 in Remote Control Setup List was set to “-19.00”.

Example: If the level of the Fader component (4 ch) is assigned as “any” to Index 1 in Remote Control Setup List
Command: setr PROC:Remote/1 2 0 100
Response: OK setr PROC:Remote/1 2 0 -1900
Meaning: Set Ch 3 of the parameter assigned to index 1 in Remote Control Setup List to 100 step increase.
Ch 3 of the parameter which is assigned to index 1 in Remote Control Setup List was set to “-19.00”.

3.3.6. Meter control

2-16) Transmission request

Command	Option 1	Option 2	Description
mtrstart	PROC:Remote/ IndexNo	(interval)	Requests the meter data value
mtrstart	PROC:Remote/ IndexNo>PeakHold	(interval)	Requests the peak hold meter value.

Details: **IndexNo** = Index number assigned in Remote Control Setup List

(interval) = Minimum transmission interval (msec)

Response

Response string	Description
OK mtrstart PROC:Remote/ IndexNo	Meter data transmission setting complete
OK mtrstart PROC:Remote/ IndexNo>PeakHold	Peak hold meter data transmission setting complete

Example: Command: mtrstart PROC:Remote/2 1000

Notification: OK mtrstart PROC:Remote/2

NOTIFY mtr PROC:Remote/2 level 71 71 71 71 69 68

NOTIFY mtr PROC:Remote/2 level 71 71 71 71 69 68

* The meter value is expressed using a 2-digit hexadecimal.

Meaning: Send the meter data assigned to index 2 in Remote Control Setup List at 1000 msec intervals.

A request for the meter assigned to index 2 in Remote Control Setup List was received, so the data will be transmitted.

The meter type assigned to index 2 in Remote Control Setup List is "level", and the meter values are the following:

0x71, 0x71, 0x71, 0x71, 069, 0x68, ...

0x71, 0x71, 0x71, 0x71, 069, 0x68, ...

Example: Command: mtrstart PROC:Remote/2>PeakHold 1000

Notification: OK mtrstart PROC:Remote/2>PeakHold

NOTIFY mtr PROC:Remote/2>PeakHold level 71 71 71 71 69 68

NOTIFY mtr PROC:Remote/2>PeakHold level 71 71 71 71 69 68

* The meter value is expressed using a 2-digit hexadecimal.

Meaning: Send the meter peak value of the meter assigned to index 2 in Remote Control Setup List at 1000 msec intervals.

A request for the meter peak value of the meter assigned to index 2 in Remote Control Setup List was received, so the data will be transmitted.

The meter type assigned to index 2 in Remote Control Setup List is "level", and the meter values are the following:

0x71, 0x71, 0x71, 0x71, 069, 0x68, ...

0x71, 0x71, 0x71, 0x71, 069, 0x68, ...

2-17) Stop request

Command	Option 1	Description
mtrstop	PROC:Remote/ IndexNo	Requests that the meter data be stopped.
mtrstop	PROC:Remote/ IndexNo>PeakHold	Requests that the peak hold meter data be stopped.

Details: **IndexNo** = Index number assigned in Remote Control Setup List

Response

Response string	Description
OK mtrstop PROC:Remote/ IndexNo	Meter data stop setting complete
OK mtrstop PROC:Remote/ IndexNo>PeakHold	Peak hold meter data stop setting complete

Example: Command: mtrstop PROC:Remote/2

Notification: OK mtrstop PROC:Remote/2

Meaning: Stop the meter data assigned to Index 2 in Remote Control Setup List.

The request to stop the meter data assigned to Index 2 in Remote Control Setup List was received.

Example: Command: mtrstop PROC:Remote/2>PeakHold

Notification: OK mtrstop PROC:Remote/2>PeakHold

Meaning: Stop the peak hold meter data assigned to Index 2 in Remote Control Setup List.

The request to stop the peak hold meter data assigned to Index 2 in Remote Control Setup List was received.

3.3.7. Snapshot processing

2-18) Current snapshot number query

Command	Option 1	Description
sscurrent_ex	(category)	Queries the current snapshot number of the specified category

Details: **(category)** = When "parameter_set" is specified, the current parameter set ID is returned.
When a parameter set ID is specified, the snapshot number is returned.

If you want to query the snapshot number, firstly, specify the category to "parameter_set" to query the parameter set ID. Then assign the parameter set ID to query the snapshot number.

Response

Response string	Description
OK sscurrent_ex (category) (index) (status)	Current parameter set ID and snapshot number query

Details: **(category)** = "parameter_set" or current parameter set ID
(index) = Current snapshot number 1 - 100
(status) = unmodified
 There is no parameter change after recalling.
 modified
 There is a parameter change after recalling.

Important: When "parameter_set" is specified to the category, "unmodified" will be returned.
When a parameter set ID is specified to the category, "modified" is returned.

Example: Command: sscurrent_ex parameter_set
Notification: OK sscurrent_ex 2 unmodified
Command: sscurrent_ex 2
Notification: OK sscurrent 2 10 modified

Meaning: Query the last parameter set that was recalled.
The parameter set ID is 2.
Query the last snapshot number that was recalled.
The parameter set ID is 2 and the snapshot number is 10.

2-19) Snapshot recall processing

Command	Option 1	Option 2	Description
ssrecall_ex	(id)	(index)	Recalls the snapshot

Details: **(id)** = Parameter set ID
(index) = Snapshot number 1 - 100

Response

Response string	Description
OK ssrecall_ex (id) (index)	Response to the recall query

Example: Command: ssrecall_ex 5000 10
Notification: OK ssrecall_ex 5000 10
Meaning: Recall the snapshot assigned to index 10 of the parameter set ID 5000.
The snapshot assigned to index 10 of the parameter set ID 5000 was recalled.

3.4. Extended commands

3.4.1. Product information query request

3-1) Protocol version query

Command	Option 1	Description
devinfo	protocolver	Queries the external control protocol version

Response

Response string	Description
OK devinfo protocolver "xxxx"	External control protocol version

Details: xxxx = Version

Example: Command: devinfo protocolver
 Notification: OK devinfo protocolver "1.0.0"
 Meaning: Query the protocol version.
 Protocol version = V1.0.0

3-2) Parameter set version query

Command	Option 1	Description
devinfo	paramsetver	Queries the parameter set version

Response

Response string	Description
OK devinfo paramsetver "xxxx"	Parameter set version

Details: xxxx = Version

Example: Command: devinfo paramsetver
 Notification: OK devinfo paramsetver "PROC:1.0.0"
 Meaning: Query the parameter set version.
 Parameter set version = PROC:1.0.0

3-3) Firmware version query

Command	Option 1	Description
devinfo	version	Queries the firmware version

Response

Response string	Description
OK devinfo version "xxxx"	Firmware version

Details: xxxx = Version

Example: Command: devinfo version
 Notification: OK devinfo version "1.0.0"
 Meaning: Query the firmware version.
 Firmware version = V1.00

3-4) Product name query

Command	Option 1	Description
devinfo	productname	Queries the product name

Response

Response string	Description
OK devinfo productname "xxxx"	Product name

Details: xxxx = Product name

Example: Command: devinfo productname
Notification: OK devinfo productname "DME7"
Meaning: Query the product name.
Product name = "DME7"

3-5) Product manufacture name query

Command	Option 1	Description
devinfo	manufacturer	Queries the product manufacture name

Response

Response string	Description
OK devinfo manufacturer "xxxx"	Product manufacture name

Details: xxxx = Product manufacture name

Example: Command: devinfo manufacturer
Notification: OK devinfo manufacturer "Yamaha Corporation"
Meaning: Query the manufacturer name.
Manufacturer name = "Yamaha Corporation"

3-6) Serial number query

Command	Option 1	Description
devinfo	serialno	Queries the serial number

Response

Response string	Description
OK devinfo serialno "xxxx"	Serial number

Details: xxxx = Serial number

Example: Command: devinfo serialno
Notification: OK devinfo serialno "ZA37640CHNET101001"
Meaning: Query the serial number.
Serial number = "ZA37640CHNET101001"

3-7) Device category query

Command	Option 1	Description
devinfo	category	Queries the device category

Response

Response string	Description
OK devinfo category "xxxx"	Device category

Details: xxxx = Device category
 DME7: "processor"

Example: Command: devinfo category
 Notification: OK devinfo category "processor"
 Meaning: Query the category.
 Device category="processor"

3-8) Device ID query

Command	Option 1	Description
devinfo	deviceid	Queries the device ID

Response

Response string	Description
OK devinfo deviceid "xxx"	Device ID

Details: xxxx = Device ID
 * 3-digit hexadecimal

Example: Command: devinfo deviceid
 Notification: OK devinfo deviceid "001"
 Meaning: Query the device ID (unit ID).
 Device ID = "001"

Note: The device ID corresponds to the UNIT ID.

3-9) Device name query

Command	Option 1	Description
devinfo	devicename	Queries the device name assigned by the user

Response

Response string	Description
OK devinfo devicename "xxxx"	Device name assigned by the user

Details: xxxx = Device name

Example: Command: devinfo devicename
 Notification: OK devinfo devicename "DME7xxx"
 Meaning: Query the device name.
 Device name = "DME7xxx"

Important: The character encoding for the device name conforms to the setting specified by the scpmode encoding command.

3-10) Audio input port number query

Command	Option 1	Description
devinfo	inputport	Queries the number of audio input ports

Response

Response string	Description
OK devinfo inputport "xxx"	The number of audio input ports

Details: xxx = The number of input ports

Example: Command: devinfo inputport
 Notification: OK devinfo inputport "64"
 Meaning: Queries the number of input ports.
 The number of input ports = 64 ports

3-11) Audio output port query

Command	Option 1	Description
devinfo	outputport	Queries the number of audio output ports

Response

Response string	Description
OK devinfo outputport (value)	The number of audio output ports

Details: (value) = The number of input ports

Example: Command: devinfo outputport
 Notification: OK devinfo outputport 64
 Meaning: Queries the number of output ports.
 The number of output ports = 64 ports

3-12) GPI IN port number query

Command	Option 1	Description
devinfo	gpi	Queries the number of GPI IN ports

Response

Response string	Description
OK devinfo gpi (value)	The number of GPI IN ports

Details: (value) = The number of GPI IN ports

Example: Command: devinfo gpi
 Notification: OK devinfo gpi 16
 Meaning: Queries the number of GPI IN ports.
 The number of GPI IN ports = 16 ports

3-13) GPI OUT port number query

Command	Option 1	Description
devinfo	gpo	Queries the number of GPI OUT ports

Response

Response string	Description
OK devinfo gpo (value)	The number of GPI OUT ports

Details: (value) = The number of GPI OUT ports

Example: Command: devinfo gpo
 Notification: OK devinfo gpo 8
 Meaning: Queries the number of GPI OUT ports.
 The number of GPI OUT ports = 8 ports

3.4.2. Parameter information query request**3-14) Parameter number query**

Command	Description
prmnum	Queries the maximum number of parameters that can be assigned to Remote Control Setup List

Response

Response string	Description
OK prmnum (value)	The maximum number of parameters that can be assigned to Remote Control Setup List

Details: (value) = The maximum number of parameters that can be assigned to Remote Control Setup List
 The DME7 always returns 1000.

Example: Command: prmnum
 Notification: OK prmnum 1000
 Meaning: Queries the maximum number of parameters or meters that can be assigned to Remote Control Setup List.
 1000

3-15) Nth parameter information query

Command	Option 1	Description
prminfo	(index)	Queries the parameter address at the specified index in Remote Control Setup List

Details: (index) = Index number assigned in Remote Control Setup List

Response

Response string	Description
OK prminfo (index) "address" (xnum) (ynum) (min) (max) (default) "unit" (type) (ui) (attrib) (scaling)	Parameter information at the specified index

Details: (index) = Index number assigned in Remote Control Setup List
 "address" = Parameter address text
 Address specifications depend on the device specifications to be controlled.
 (xnum) = Number of sub-address X
 (ynum) = Number of sub-address Y
 (min) = The minimum parameter value (raw value). It is not always "0" since "Min" can be specified.
 It indicates "min" specified in Remote Control Setup List.
 (max) = The maximum parameter value (raw value), the maximum number of characters for string parameters (raw value)
 It indicates "max" specified in Remote Control Setup List.
 (default) = The default parameter value (raw value), the default characters for string parameters (raw value)
 "unit" = Unit string
 (type) = Refer to the parameter type code below.
 (ui) = Refer to the UI type code below.
 (attrib) = Read/Write functions: rw = Both read and write, r = Read only
 (scaling) = Magnification value (1,10,100, ...)

Parameter type

integer	Integer	An integer value that can be handled within the range of Min to Max value.
freq	Frequency	Frequency values that specify the correspondence between actual values and values handled by users according to ISO-266 standard.
binary	Hexadecimal	This is not Min or Max value, it's the parameters that are treated as hexadecimal numbers of up to 4 bytes. In this type, the operation of setn, setr, getn is not guaranteed.
string	String	Parameters treated as strings. In this type, the operation of setn, setr, getn is not guaranteed.

Recommended UI type

The most suitable UI type for the parameter is shown.

The controller side may or may not refer to this value.

any	Unspecified	No specific recommended UI.
fader	Fader type UI	For a UI that can be continuously changed linearly like a fader.
latchsw	Latch switch type UI	For two-state slide switch, toggle button, etc.
unlatchsw	Unlatch switch type UI	For unlatch type two-state button, etc.
list	List selection type UI	For UI that allows you to select alternatives such as a pull-down menu, etc.
knob	Knob type UI	For UI that can be continuously changed like a knob or encoder (this does not have to be linear like the fader type UI)

* For one address, there are parameter arrays {number of sub-address X × number of sub-address Y}.

Example: Number of Sub-address X = 1 → Only 1 parameter
 Number of Sub-address Y = 1

 Number of Sub-address X = 96 → One-dimensional array with 96 parameters
 Number of Sub-address Y = 1

 Number of Sub-address X = 96 → Two-dimensional array with 96 x 24 parameters
 Number of Sub-address Y = 24

* Min and Max values are intended for the direction of operation in the control.
 (Example: For fader and slider, the bottom or left is the Min Direction. For knob type, the counter-clockwise direction is the Min direction).
 Therefore, it is not always the case that Min <Max numerically, and it is important to note that the Min direction may be numerically larger, like the case of HA Gain.

* Read/Write attributes are always fixed for each address.

The read / write attribute itself does not change even if the parameter operation is locked depending on the state of the device. In that case, an error notification will be shown when an operation request is made.

Example: Command: prminfo 1
 Notification: OK prminfo 1 "level" 144 1 10 -62 0 "dB" integer knob rw
 Meaning: Query the parameter information assigned to index 1 in Remote Control Setup List.
 The address is "level", and there are (144x1) parameters.
 Range = +10 to -62, default value = 0
 Unit string = "dB"
 Type = Integer value
 Recommended UI type = Knob type
 Read/Write functions = Both read and write

* An error notification will be returned when a meter is assigned to the specified index in Remote Control Setup List.

3.4.3. Meter information query request

3-16) Meter number query

Command	Description
mtrnum	Queries the maximum number of meters that can be assigned to Remote Control Setup List

Response

Response string	Description
OK mtrnum (value)	The maximum number of meters that can be assigned to Remote Control Setup List

Details: (value) = The maximum number of meters that can be assigned to Remote Control Setup List
The DME7 always returns 1000.

Example: Command: mtrnum
Notification: OK mtrnum 1000
Meaning: Query the maximum number of meters that can be assigned to Remote Control Setup List.
1000

3-17) Nth meter information query

Command	Option 1	Description
mtrinfo	(index)	Queries the meter information assigned at the specified index in Remote Control Setup List

Details: (index) = Index number assigned in Remote Control Setup List

Response

Response string	Description
OK prminfo (index) "address" (xum) (ynum) (type)	Nth meter address information

Details: (index) = Index number assigned in Remote Control Setup List
"address" = Meter address text
Address specifications depend on the device specifications to be controlled.
(num) = The number of meter data included in the index
(type) = Refer to the meter type code below.

Meter types

level	Level meter	See "5. Meter Value".
hold	Level hold meter	See "5. Meter Value".
gr	GR meter	See "5. Meter Value".
vu	VU meter	
raw	Raw value. The table is interpreted for each meter address.	
gr+100	GR+ meter with 0.01dB resolution	

* For one meter address, there are meter data arrays for the number of data.

Example: Number of data = 1 → Only 1 parameter
Number of data = 128 → 128 one-dimensional arrays

Example: Command: mtrinfo 1
Notification: OK mtrinfo1 "level" 128 level
Meaning: Query information of the meter assigned to index 1 in Remote Control Setup List.
The address is "level" and there are 128 meter data.
The meter type is a level meter.

* An error notification will be returned when a parameter is assigned to the specified index in Remote Control Setup List.

3.4.4. Snapshot information query request

3-18) Snapshot number query

Command	Option 1	Description
ssnum_ex	(id)	Queries number of snapshots

Details: (id) = Parameter set ID

Response

Response string	Description
OK ssnum_ex (num)	Number of snapshots

Details: (num) = Number of parameter sets

Example: Command: ssnum_ex 5000
 Notification: OK ssnum_ex 100
 Meaning: Query the number of snapshots of parameter set ID 5000.
 The number of snapshots is 100.

3-19) Snapshot information query

Command	Option 1	Option 2	Description
ssinfo_ex	(id)	(index)	Queries the specified snapshot information

Details: (id) = Parameter set ID
 (index) = Snapshot number 1 - 100

Response

Response string	Description
OK ssinfo_ex (id) (index) "numtext" "title" "comment" (attrib)	Nth snapshot information

Details: "numtext" = Text expressing the relevant snapshot number
 "title" = Title text of the relevant snapshot
 "comment" = Comment text of the relevant snapshot. (Reserved for future use. Since DME7 does not currently use comments, "" will be returned.)
 (attrib) = Relevant preset attribute
 preinst = Preinstalled snapshot
 reserve = Reserved area
 user = User snapshot available
 empty = Empty

Example: Command: ssinfo_ex 5000 10
 Notification: OK ssinfo 5000 10 "010" "open time snapshot" "" user
 Meaning: Query the contents of the snapshot at index 10 of the parameter set ID 5000.
 The snapshot at index 10 of parameter set ID 5000 contains:
 display number = "010"
 title = "open time snapshot"
 comment = ""
 and is a stored snapshot.

Important: The character encoding for snapshot titles and comments conforms to the setting specified by the scpmode encoding command.

3.4.5. Identify

3-20) Identify

Command	Option 1	Description
identify	(duration)	Enter the identify display mode for specified seconds

Details: **(duration)** = Decimal number
 "0" requests a stop.
 1 to 60 [sec] indicates the time to keep the device in the identify mode.

Response

Response string	Description
OK identify (duration)	The device enters identify mode for <duration> seconds.

* If the requested parameter value is outside the range, the value is adjusted within the range and set.
 If this occurs, the result notification will be OKm instead of OK.

Example: Command: identify 3
 Notification: OK identify 3
 Meaning: Enter the identify mode for 3 seconds.
 The device entered the identify mode.

3.4.6. Event processing request

3-21) Playback type setting

Command	Option 1	Option 2	Option 3	Description
event	PROC:AudioPlayerSetType	"index=xxxx"	"type=yyyy"	Sets the playback type

Details: xxxx = Index
 yyyy = noAssign, 1song, folder

Reference: listitemnum, listitem

Response

Response string	Description
OK event PROC:AudioPlayerSetType "index=1" "type=noAssign"	Not assigned
OK event PROC:AudioPlayerSetType "index=1" "type=1song"	Song
OK event PROC:AudioPlayerSetType "index=1" "type=folder"	Folder

Example: Command: event PROC:AudioPlayerSetType "index=1" "type=1song"
 Notification: OK event PROC:AudioPlayerSetType "index=1" "type=1song"
 Meaning: Set the playback type to "song".
 The playback type was set to "song".

3-22) Song/folder path setting

Command	Option 1	Option 2	Option 3	Description
event	PROC:AudioPlayerSetPath	"index=xxxx"	"path=yyyy"	Sets the song/folder path

Details: xxxx = Index
 yyyy = Song/folder path

Reference: listitemnum, listitem

Response

Response string	Description
OK event PROC:AudioPlayerSetPath "index=1" "path=song.wav"	Song/folder path setting response

Example: Command: event PROC:AudioPlayerSetPath "index=1" "path=song.wav"
 Notification: OK event PROC:AudioPlayerSetPath "index=1" "path=song.wav"
 Meaning: Set the path to song.wav.
 The path was set to song.wav.

3-26) Song playback status query

Command	Option 1	Option 2	Description
event	PROC:AudioPlayerGetStatus	""	Queries the song playback status

Response

Response string	Description
OK event PROC:AudioPlayerGetStatus "status=stop"	Stop
OK event PROC:AudioPlayerGetStatus "status=play"	Play
OK event PROC:AudioPlayerGetStatus "status=pause"	Pause
OKm event PROC:AudioPlayerGetStatus "sdcard is not inserted"	There is no SD memory card inserted.

* OKm is returned if there is no SD memory card inserted.

Example: Command: event PROC:AudioPlayerGetStatus
 Notification: OK event PROC:AudioPlayerGetStatus "status=stop"
 Meaning: Query the song playback status.
 Stopped.

3-27) Play, stop, and other transport operation

Command	Option 1	Option 2	Description
event	PROC:AudioPlayerTransport	"operation=stop"	Stop
		"operation=play"	Play
		"operation=prev"	Previous song
		"operation=next"	Next song

Response

Response string	Description
OK event PROC:AudioPlayerTransport "operation=stop"	Stop
OK event PROC:AudioPlayerTransport "operation=play"	Play
OK event PROC:AudioPlayerTransport "operation=prev"	Previous song
OK event PROC:AudioPlayerTransport "operation=next"	Next song
OKm event PROC:AudioPlayerTransport "sdcard is not inserted"	There is no SD memory card inserted.
OKm event PROC:AudioPlayerTransport "song is not set up"	The playback song is not specified.

* OKm is returned if there is no SD memory card inserted or the playback song is not specified.

Example: Command: event PROC:AudioPlayerTransport "operation=stop"
 Notification: OK event PROC:AudioPlayerTransport "operation=stop"
 Meaning: Stop the playback.
 Playback was stopped.

3-28) Currently playing or selected song information query

Command	Option 1	Option 2	Description
event	PROC:AudioPlayerGetCurrentSong	""	Queries the currently playing or selected song information

Response

Response string	Description
OK event PROC:AudioPlayerGetCurrentSong "index=xxxx"	Currently playing or selected song information
OKm event PROC:AudioPlayerGetCurrentSong "sdcard is not inserted"	There is no SD memory card inserted.
OKm event PROC:AudioPlayerGetCurrentSong "song is not set up"	The playback song is not specified.

* OKm is returned if there is no SD memory card inserted or the playback song is not specified.

Details: xxxx = Index

Example: Command: event PROC:AudioPlayerGetCurrentSong ""
 Notification: OK event PROC:AudioPlayerSetCurrentSong "index=1"
 Meaning: Query the information of the song currently being played.
 The song that is being played is index 1.

3-29) Playback song designation

Command	Option 1	Option 2	Description
event	PROC:AudioPlayerSetCurrentSong	"index=xxxx"	Playback song designation

Details: xxxx = Index

Reference: listitemnum, listitem

Response

Response string	Description
OK event PROC:AudioPlayerSetCurrentSong "index=xxxx"	The specified song that will be played
OKm event PROC:AudioPlayerSetCurrentSong "sdcard is not inserted"	There is no SD memory card inserted.

* OKm is returned if there is no SD memory card inserted.

Details: xxxx = Index

Example: Command: event PROC:AudioPlayerSetCurrentSong "index=2"
 Notification: OK event PROC:AudioPlayerSetCurrentSong "index=2"
 Meaning: Play the file at index 2.
 Index 2 was set as the playback song.

3-30) Display font designation

Command	Option 1	Option 2	Description
event	PROC:Language	"type1"	M Plus: Japanese Kana and Kanji, English, all European languages
		"type2"	Dyna: Chinese characters, Japanese Kana, M Plus: English, all European languages

* Kana = Hiragana and Katakana

Response

Response string	Description
OK event PROC:Language "type1"	The display font was set to type1.
OK event PROC:Language "type2"	The display font was set to type2.

Example: Command: event PROC:Language "type1"
 Notification: OK event PROC:Language "type1"
 Meaning: Set the display font to type1.
 The display font was set to type1.

3-31) Scheduler event enable/disable setting

Command	Option 1	Option 2	Option 3	Description
event	PROC:SchedulerSetEnable	"index=xxxx"	"enable=yyyy"	Enables/disables the scheduler event

Details: xxxx = Index
 yyyy = true, false

Reference: listitemnum, listitem

Response

Response string	Description
OK event PROC:SchedulerSetEnable "index=xxxx" "enable=yyyy"	The index xxxx event enable setting was set to yyyy.
OKm event PROC:SchedulerSetEnable "scheduler is not placed"	The scheduler component is not placed.
OKm event PROC:SchedulerSetEnable "invalid index"	The specified index is out of specifiable range.
OKm event PROC:SchedulerSetEnable "enable option must be true or false"	The enable option was specified to other than "true" or "false".

Details: xxxx = Index
 yyyy = true, false

Example: Command: event PROC:SchedulerSetEnable "index=2" "enable=true"
 Notification: OK event PROC:SchedulerSetEnable "index=2" "enable=true"
 Meaning: Set the index 2 event enable setting to "true".
 The index 2 event enable setting was set to "true".

3-32) Scheduler event time setting

Command	Option 1	Option 2	Option 3	Description
event	PROC:SchedulerSetTime	"index=xxxx"	"time=yyyy"	Sets the scheduler event time

Details: xxxx = Index
 yyyy = Time

Reference: listitemnum, listitem

Response

Response string	Description
OK event PROC:SchedulerSetTime "index=xxxx" "time=yyyy"	The index xxxx event time was set to yyyy.
OKm event PROC:SchedulerSetTime "scheduler is not placed"	The scheduler componet is not placed.
OKm event PROC:SchedulerSetTime "invalid index"	The specified index is out of the specifiable range.
OKm event PROC:SchedulerSetTime "invalid time"	The specified time was invalid.

Details: xxxx = Index
 yyyy = Time

Example: Command: event PROC:SchedulerSetTime "index=3" "time=9:00"
 Notification: OK event PROC:SchedulerSetTime "index=3" "time=9:00"
 Meaning: Set the index 3 event time to 9:00.
 The index 3 event time was set to 9:00.

3.4.7. List item processing

3-33) AudioPlayer item number query

Command	Option 1	Option 2	Description
listitemnum	PROC:AudioPlayer	""	Queries the number of items

Response

Response string	Description
OK listitemnum PROC:AudioPlayer (num) (head) (tail)	The number of items and the first/last index

Details: num = The number of items
 head = First index
 tail = Last index

Example: Command: listitemnum PROC:AudioPlayer
 Notification: OK listitemnum PROC:AudioPlayer 100 1 100
 Meaning: Query the number of items.
 There are 100 items, the first index is 1, and the last index is 100.

3-34) AudioPlayer item information query

Command	Option 1	Option 2	Description
listitem	PROC:AudioPlayer	(index)	Queries the item information

Response

Response string	Description
OK listitem PROC:AudioPlayer (index) "(Type) (PlayMode) (GoToTheTop) (Interval) (Name)"	Item information

Details: index = Index
 Type = NoAssign, 1Song, Folder
 PlayMode = Normal, Repeat, ShuffleRepeat
 GoToTheTop = Off, On
 Interval = 0.0 - 10.0
 Name = File name, directory name

Example: Command: listitem PROC:AudioPlayer 1
 Notification: OK listitem PROC:AudioPlayer 1 "1Song Normal On 1.0 xxx.wav"
 Meaning: Query the item information of index 1.
 Type = 1 Song, PlayMode = Normal, GoToTheTop setting = On, Interval value = 1.0, Name = xxx.wav

3-35) Scheduler public event number query

Command	Option 1	Option 2	Description
listitem	PROC:Scheduler	""	Queries the scheduler component public event number

Response

Response string	Description
OK listitemnum PROC:Scheduler (num) (head) (tail)	Event number and the head- and tail-indexes

Details: num = The total number of Public events
 head = Head-index
 tail = Tail-index

Remark: Public events are the scheduler component events with the public parameter set to 1.
 Public parameters can only be changed from ProVisionaireDesign.
 The index that can be obtained with this command is the serial number of the Public event.

Example: Command: listitemnum PROC:Scheduler
 Notification: OK listitemnum PROC:Scheduler 15 1 15
 Meaning: Query the number of events.
 The number of events: 15, head-index: 1, tail-index: 15

3-36) Scheduler event information query

Command	Option 1	Option 2	Description
listitem	PROC:Scheduler	(index)	Queries scheduler event information

Response

Response string	Description
OK listitem PROC:Scheduler (index) "(enable) (time) (name)"	Event information

Details:

- index = Index
- enable = enable, disable
- time = Event execution time
- name = Event name

Example: Command: listitem PROC:Scheduler 1
 Notification: OK listitem PROC:Scheduler 1 "enable 9:00 MorningChime"
 Meaning: Query index 1 event information.
 enable = enable, time = 9:00, name = MorningChime

3.5. Command Errors

3.5.1. Command Error Notifications

Error notification that indicates errors in commands.

If an error is found when the command is sent, this notification is returned instead of the normal successful notification.

[Notification syntax] ERROR <command name> <error code>

Command name	Alphanumeric	Name of the command that caused the error
Error code	Alphanumeric	Error description * See the error codes below.

Error code

Error code	Description
UnknownCommand	Ignored because it was an unknown command.
WrongFormat	Ignored because the command parameter format was wrong and could not be interpreted. Examples: The number of parameters is wrong. The parameter syntax is wrong.
InvalidArgument	Ignored because the command parameter content was outside the appropriate range and could not be interpreted. Examples: The parameter value is outside the range. The parameter syntax does not comply with the specifications. The letter case of the parameter is wrong.
UnknownAddress	Ignored because the specified address does not exist.
UnknownEventID	Ignored because the specified event ID does not exist.
TooLongCommand	Could not be interpreted because the command was too long.
AccessDenied	Procedure rejected because the peer device is not in a normal running state. Examples: Rejected because an ssrecall command was received in emergency run mode.
Busy	The device is busy processing; it can't receive commands.
ReadOnly	Ignored because an attempt was made to set a parameter at a read-only address.
NoPermission	Ignored because you do not have access permission.
Overload	Reduce the amount of communication as there is too much communication from the controller.
Overflow	Communication has overflowed as the device cannot receive them all.
TooManyFilters	The command could not be registered because it contains too many filters.
InternalError	An internal error may have occurred. Examples: Failed to process the command. Attempted to query or change the value of a parameter that does not exist in the device.
Clipped	The notification could not be sent because it contains more than 1000 letters.

4. Command Sequence

Below are examples of how to process remote control.

When viewed from the controller, the following major phases exist in order to perform remote control.

In the normal processing state, remote control is realized by combining various commands according to the specifications of the controller.

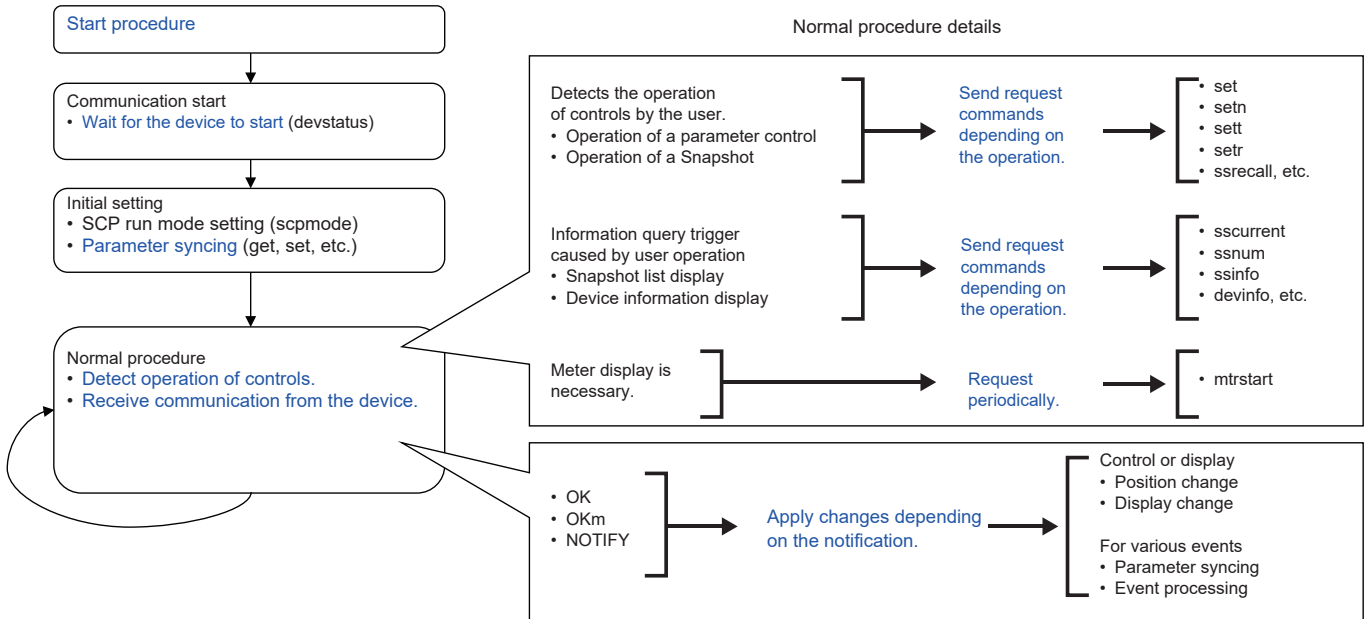

The controller designer needs to design and implement the blue items in the above figure.

The detailed sequences of various procedures are provided below.

4.1. Communication start sequence

The amount of time for the controller and the controlled device to start is different.

Remote control is an act of controlling the controlled device from the controller, so the controller must wait for the controlled device to become ready.

The controller needs to wait using the sequence below.

- If an Ethernet connection is required, the remote controller needs to establish a logical session.
- After the session is established, the controller sends devstatus commands at 1 second or longer intervals.
- If "OK devstatus runmode" or "NOTIFY devstatus runmode" is returned, the controller should check the information.
- If the controller determines that the controlled device is in normal running mode, the controller can start sending command strings to change parameter value and preset etc. If the controlled device is not in normal running mode, the controller continues trying.

Note: In order to establish remote control communication, the external controller must send [devstatus runmode] command to the device and await response.

When the device responds as [OK devstatus runmode "normal"], the device is ready to receive commands.

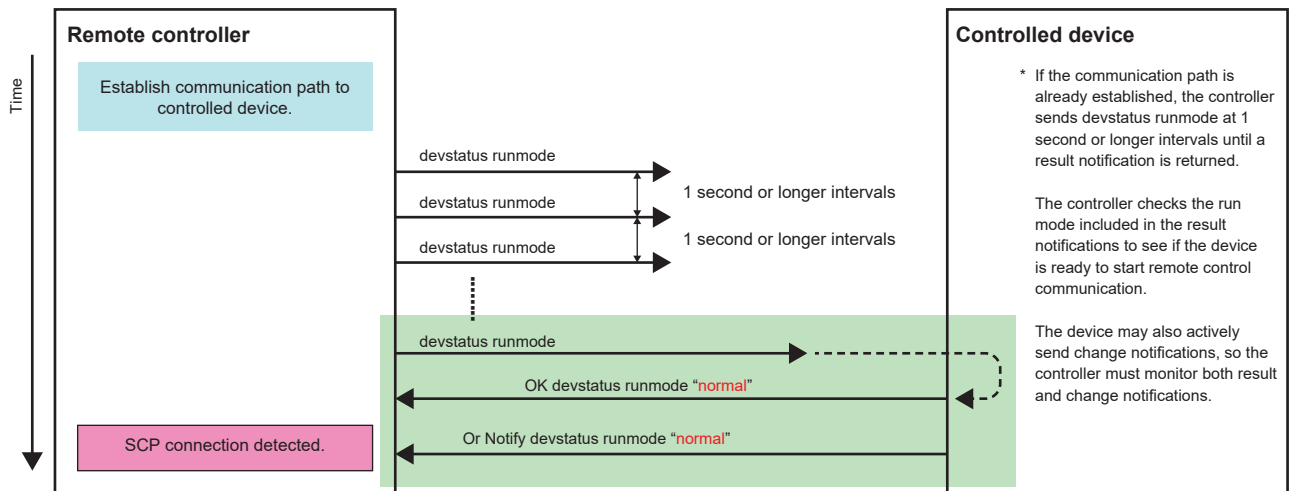

The reason for using such a sequence is provided below.

Example when the controller starts earlier than the controlled device

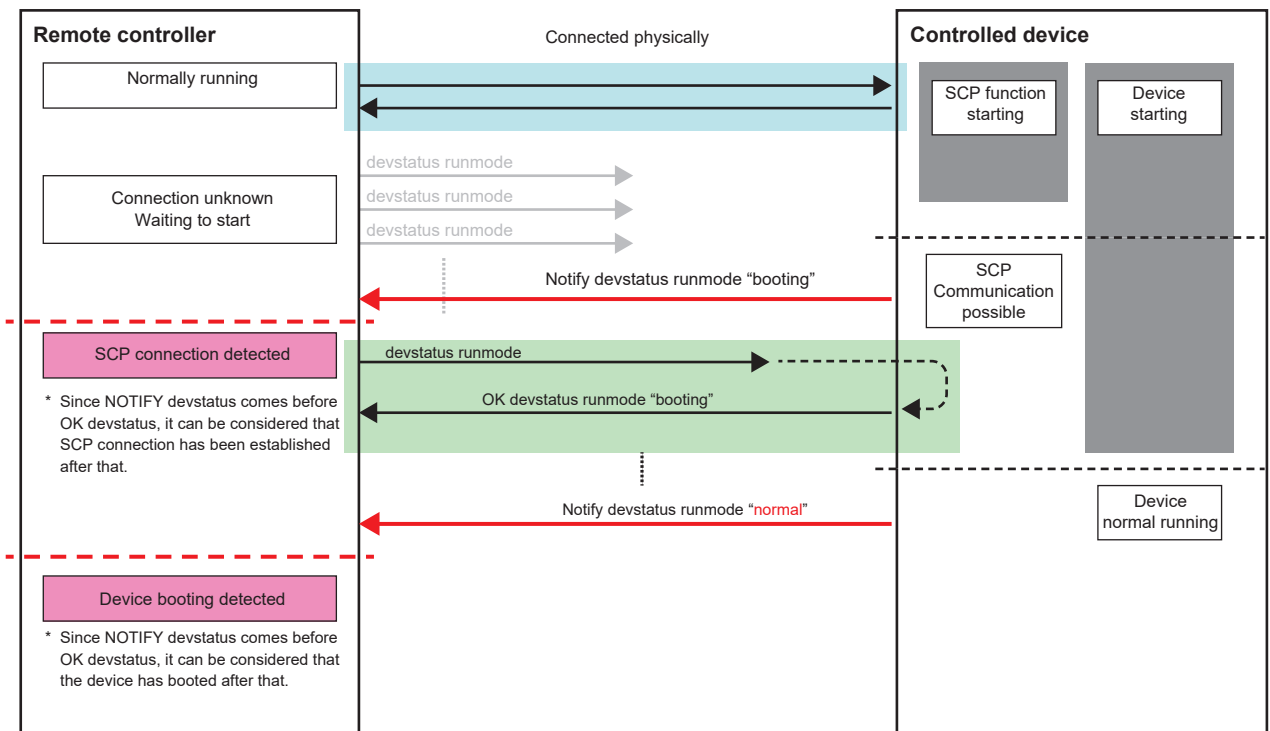

In this case, the controller can recognize that the controlled device is ready to receive commands by active NOTIFY devstatus runmode from the controlled device regardless of whether the devstatus runmode request is sent from the controller.

Example when the controlled device starts earlier than the controller

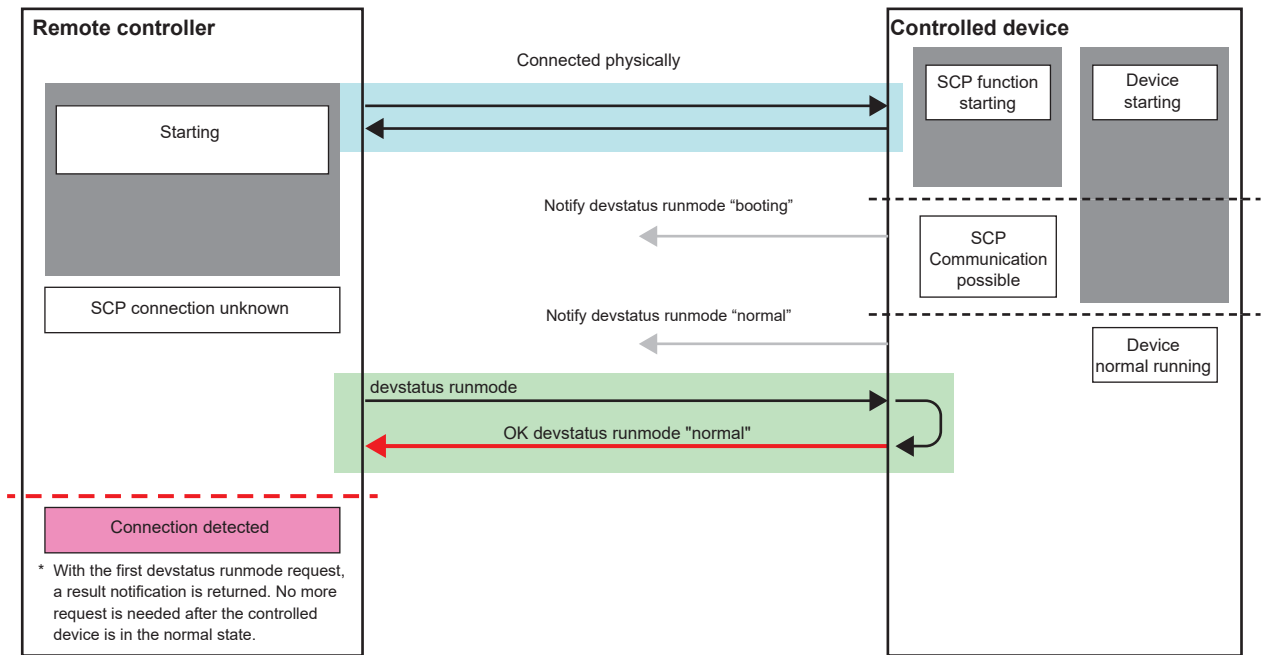

The controller can recognize that the controlled device is ready to receive commands when there is response for "devstatus runmode" command because the active NOTIFY devstatus runmode command from the controlled device has failed. In case of Ethernet connection, Ethernet logical session (e.g. port open) should be established before sending "devstatus runmode".

4.2. Information list query sequence

If you want to make a high-performance versatile controller that can control any device, it has to actively query the protocol version and parameter set version of the controlled devices as well as lists such as various addresses and snapshots. There are two types of addresses: parameter addresses and meter addresses. They use different commands with the same sequences.

Querying the protocol version and switching the operation

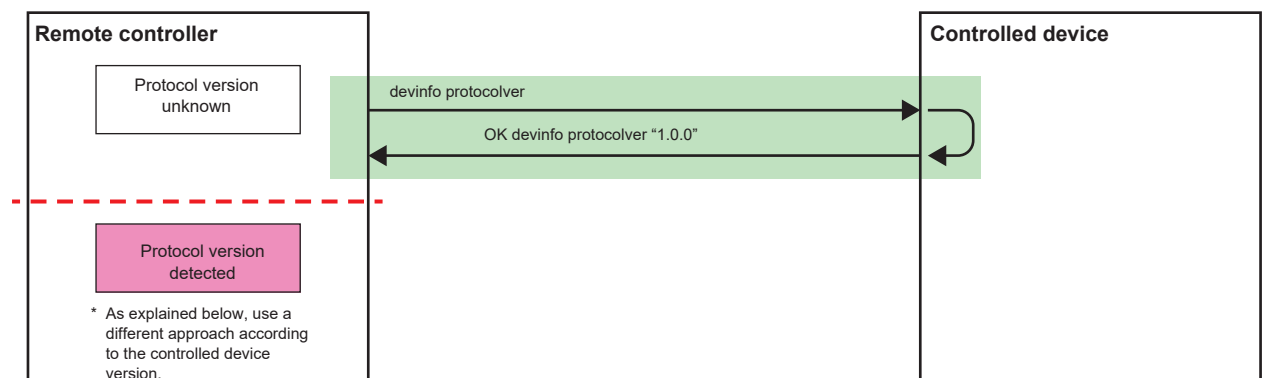

If the protocol version expected by the controller is different from the version returned by the controlled device, take the following actions.

If the actual version of the controlled device is newer than the version expected by the controller, the controller can resume the operation, since, in principle, the SCP protocol maintains backward compatibility.

However, in reality, the SCP protocol does not maintain complete backward compatibility, and newer versions may not include some commands and tag types that the earlier versions have. It is desirable that the controller responds appropriately even if an error is returned for the command sent by the controller. See below to respond appropriately.

If an error is returned for "get all", send a "get" command individually instead of "get all".

Assume that the default value is returned if a single "get" command returns an error.

Ignore if a set command returns an error.

etc.

If the actual version of the controlled device is older than the version expected by the controller, choose one of the following solutions according to the specifications of the controller.

- a) Displays a warning of an incompatible version, and the controller stops the operation.
- b) Displays a warning of version mismatch, and then the controller continue to operate.
In this case, a user needs to accept that some functions may not be available.
- c) Conforming the controlled device's protocol version, only communication compatible with the older protocol is allowed.
If some functions become unavailable for a user, display a warning of version mismatch as well.
The users need to accept any performance degradation and function restrictions that may occur.

Querying the parameter set version and switching the operation

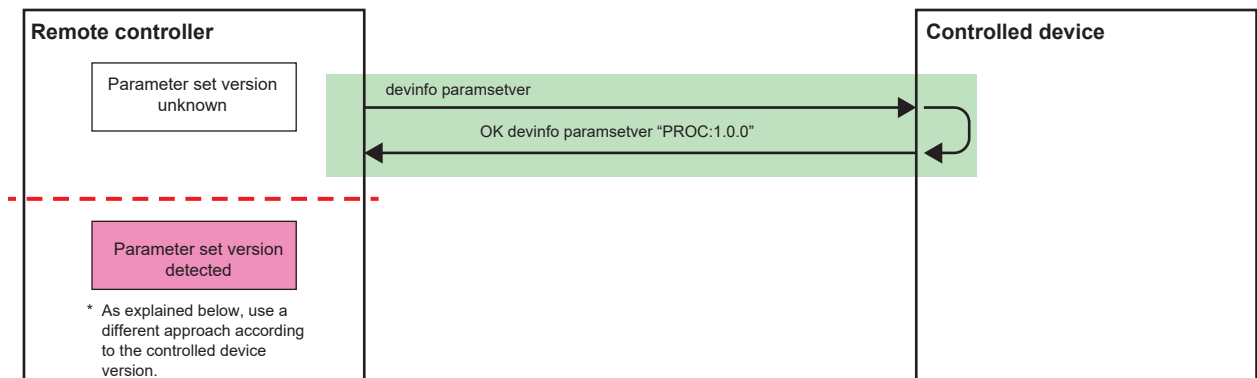

If the parameter set version expected by the controller is different from the version returned by the controlled device, take the following actions.

If the actual version of the controlled device is newer than the version expected by the controller, the controller can resume the operation, since, in principle, the SCP protocol maintains backward compatibility.

However, in reality, the SCP protocol does not maintain complete backward compatibility, and newer versions may not include some parameters that the earlier versions have. It is desirable that the controller responds appropriately even if an error is returned for the command sent by the controller. See below to respond appropriately.

- Assume that the default value is returned if a single "get" command returns an error.
- Ignore if a set command returns an error.
- etc.

If the actual version of the controlled device is older than the version expected by the controller, choose one of the following solutions according to the specifications of the controller.

- a) Displays a warning of an incompatible version, and the controller stops the operation.
- b) Displays a warning of version mismatch, and then the controller continue to operate.
In this case, a user needs to accept that some functions may not be available.
- c) Conforming the controlled device's protocol version, only communication compatible with the older protocol is allowed.
If some functions become unavailable for a user, display a warning of version mismatch as well.
The users need to accept any notice performance degradation and function restrictions that may occur.

Querying the parameter address list

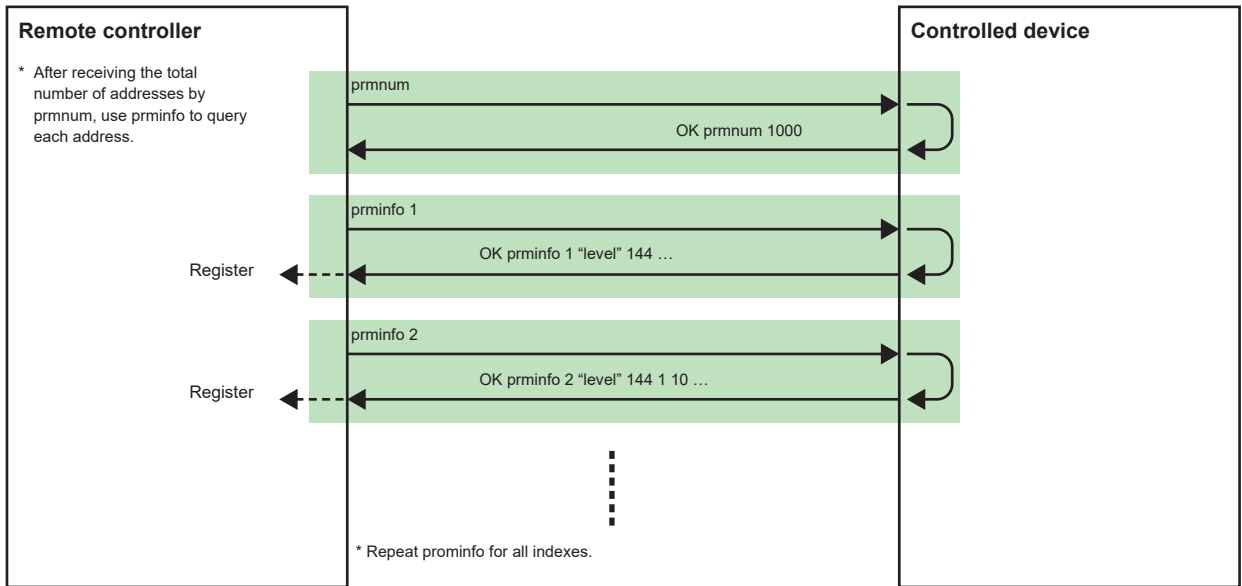

Querying the meter address list

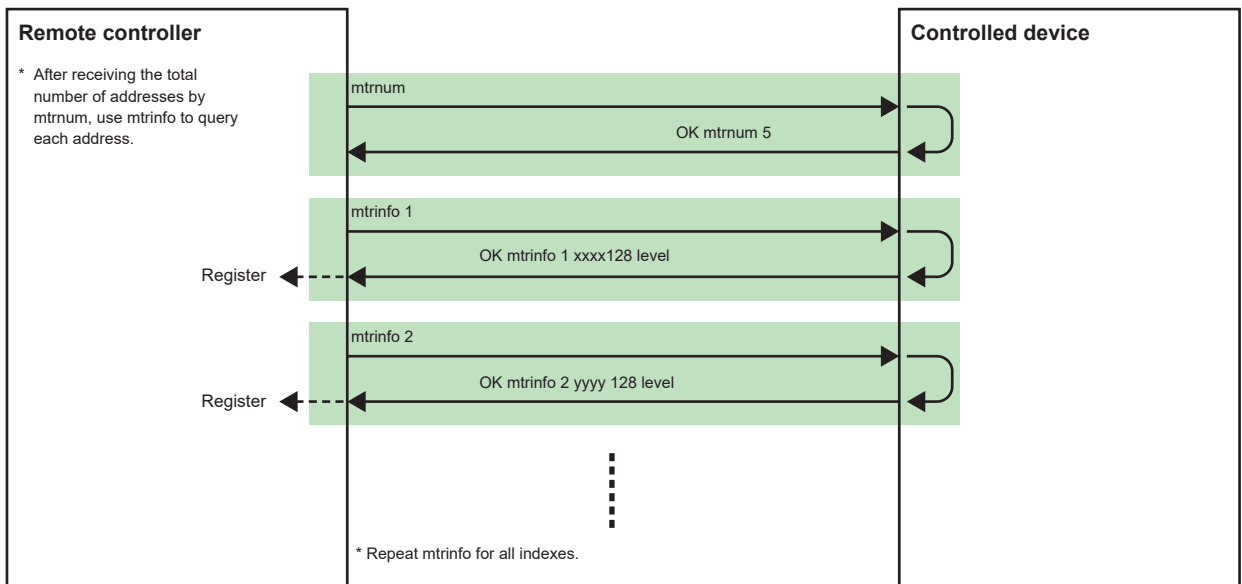

Querying the snapshot list

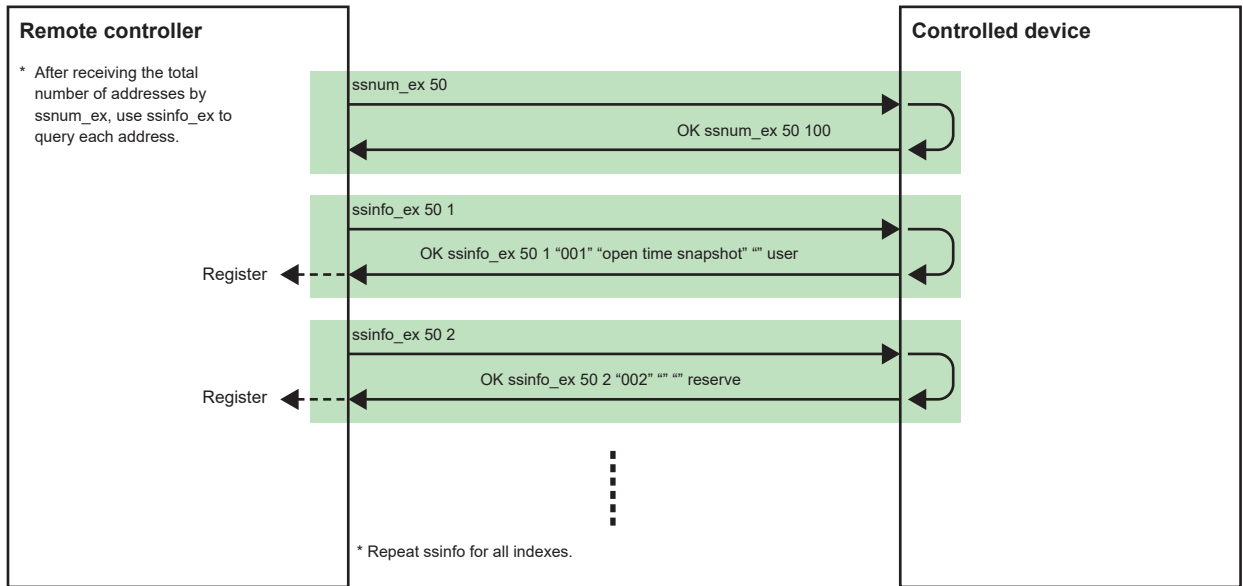

4.3. Parameter sync sequence

Immediately after communication starts, the controller does not know anything about the most recent status of the controlled device. Therefore, the controller must query all parameters that it plans to handle.

This also applies for when preset recall is executed, because the controller does not know how the device has changed.

Querying the most recent status of the controlled device or when a snapshot recall occurs

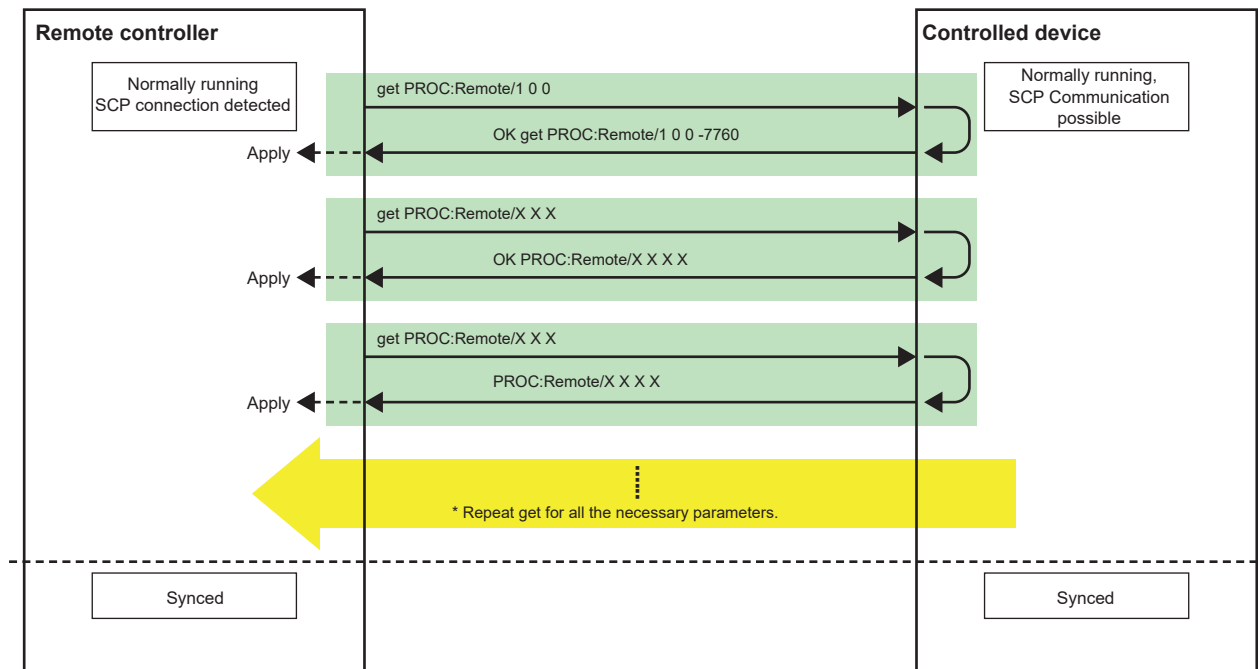

E.g. 1: Querying the parameter value
`get PROC:Remote/1 0 0`
 Query the parameter assigned to index 1 in Remote Control Setup List with raw values.

`OK get PROC:Remote/1 0 0 -7760`
 The parameter assigned to Index 1 in Remote Control Setup List is -77.60.

E.g. 2: Setting the parameter value
 set PROC:Remote/1 0 0 -7760
 Set the parameter assigned to index 1 in Remote Control Setup List to -77.60 using raw values.

OK set PROC:Remote/1 0 0 -7760 "-77.60"
 The parameter assigned to index 1 in Remote Control Setup List was set to "-77.60".

Executing this sequence synchronizes the status with the controlled device.

However, if the controller receives a change notification from the controlled device during this query sequence, the controller needs to query again.

Note that, as with a GPI controller made by user, if you want to apply the physical positions of the controller to the device, there is no need to execute the above sequence.

If you want to apply the physical positions of the controller to the device immediately after a connection is established, without any user interaction, simply use set commands to do so.

Applying the most recent status of the controller to the device

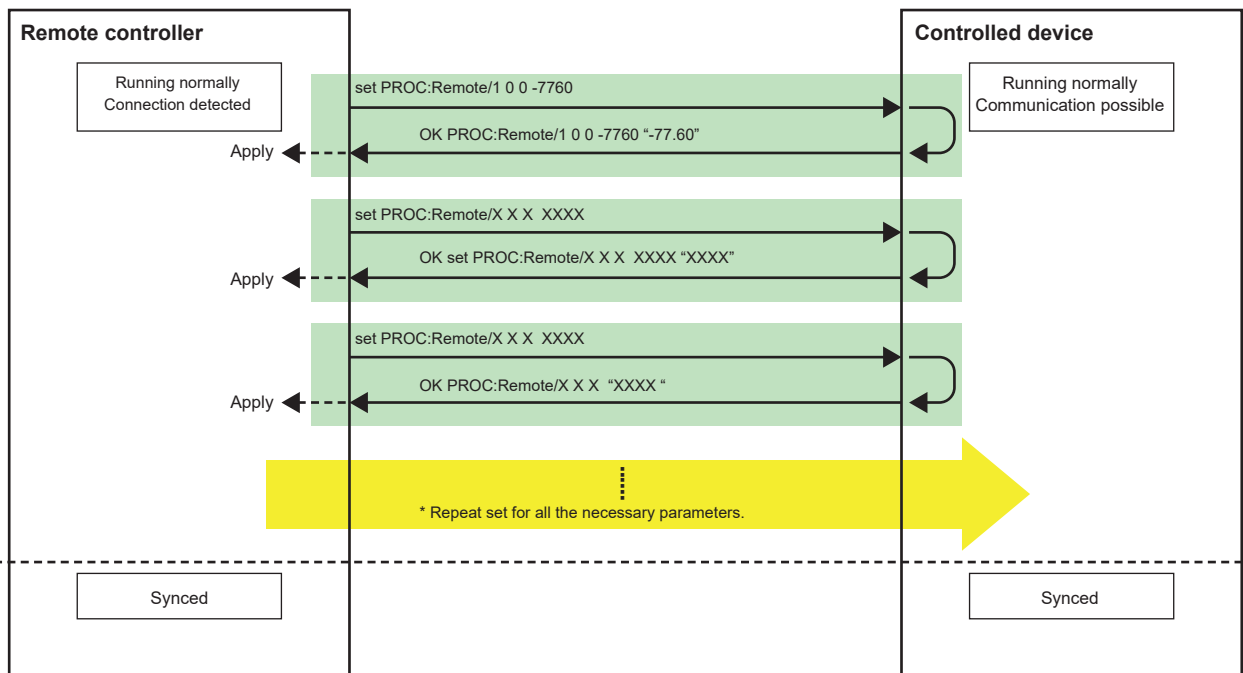

Even when the latest state on the controller side is reflected, depending on the situation, the value may be rounded on the controlled device side. Therefore, the result notification is reflected again on the controller side as necessary.

Depending on the controller specifications, the above two sequences may be used in combination.

Example: The GPI fader uses the status of the controller, but other parameters use the status of the controlled device.

Unlike "get", batch setting by specifying "all" is not possible.

4.4. Parameter setting sequence by a user

After the remote controller and controlled devices are booted and synchronized, a user can set the parameters. Please note that a set request using the appropriate "set" request is required depending on the control and parameter types.

Buttons

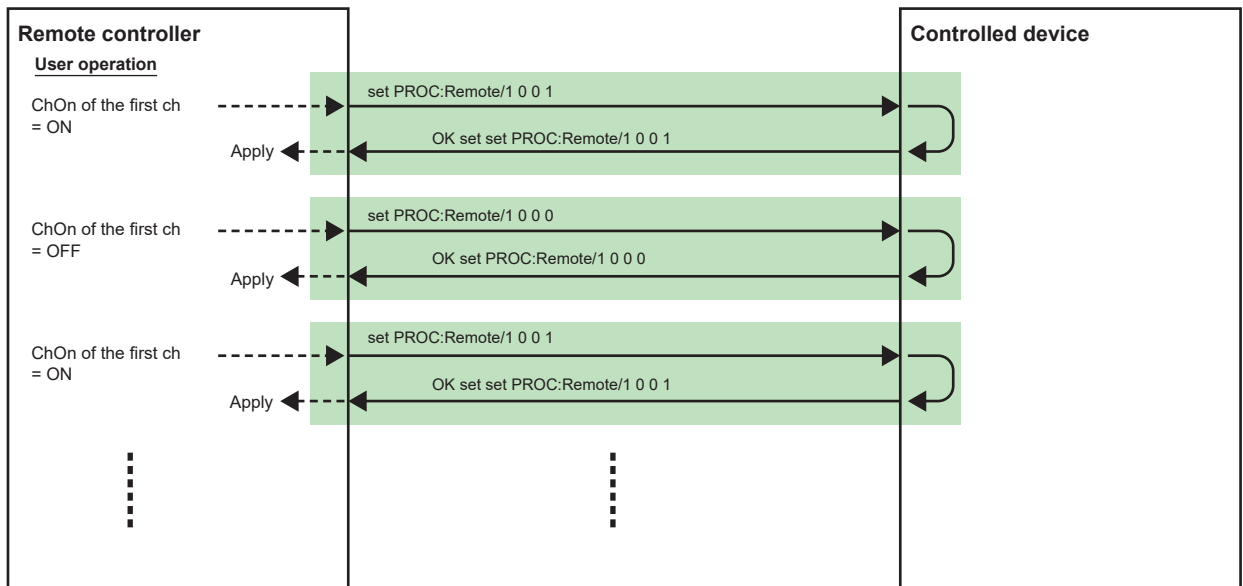

Non-motorized faders/analog volumes

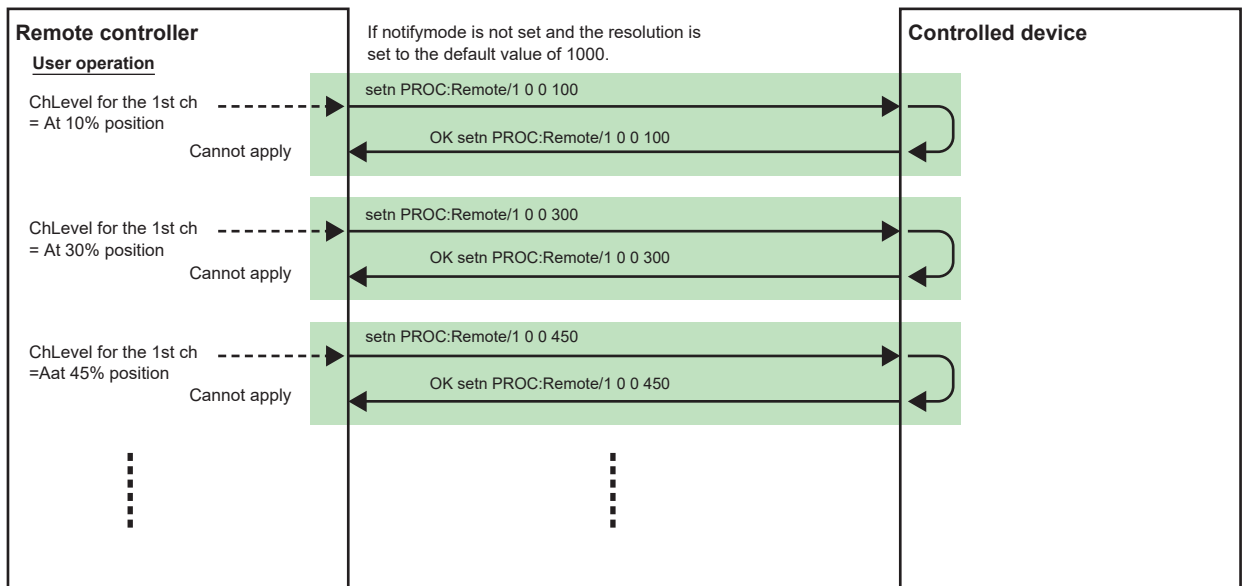

* The non-motorized faders and analog volume cannot change their physical positions even if the device receives a result notification or change notification.

Motorized faders

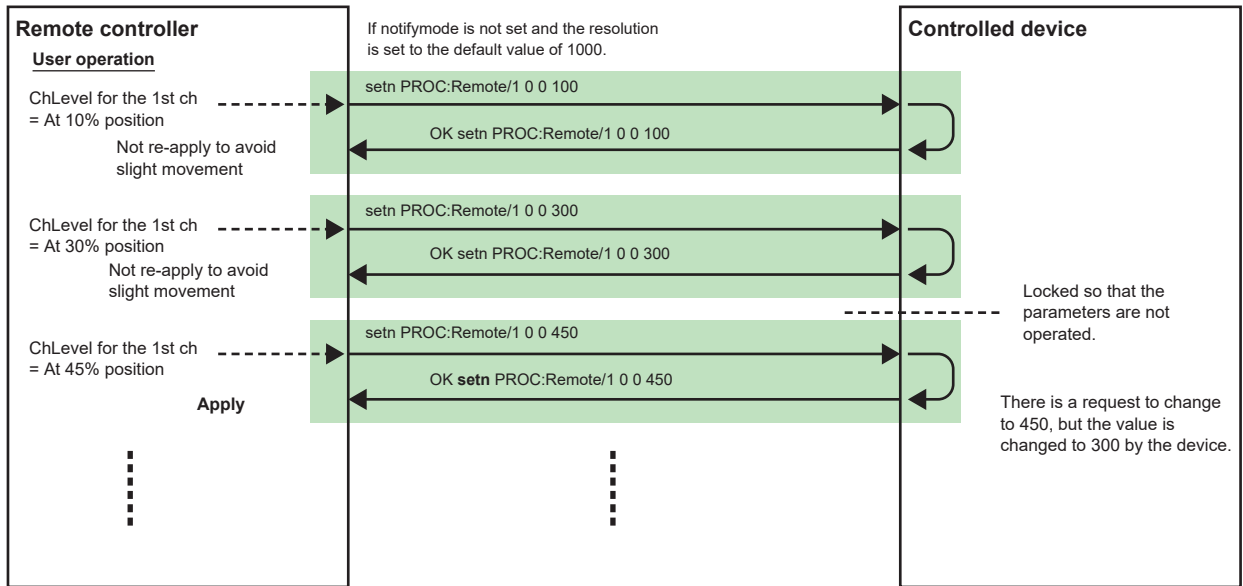

* The OK result notification will not be applied because the communication delay caused by the result notification will interfere with the user's operation. However, the parameters need to be applied when OKm result notification or NOTIFY setn change notification is returned because the parameters have changed to a state not requested by the controller.

Encoders/INC and DEC buttons

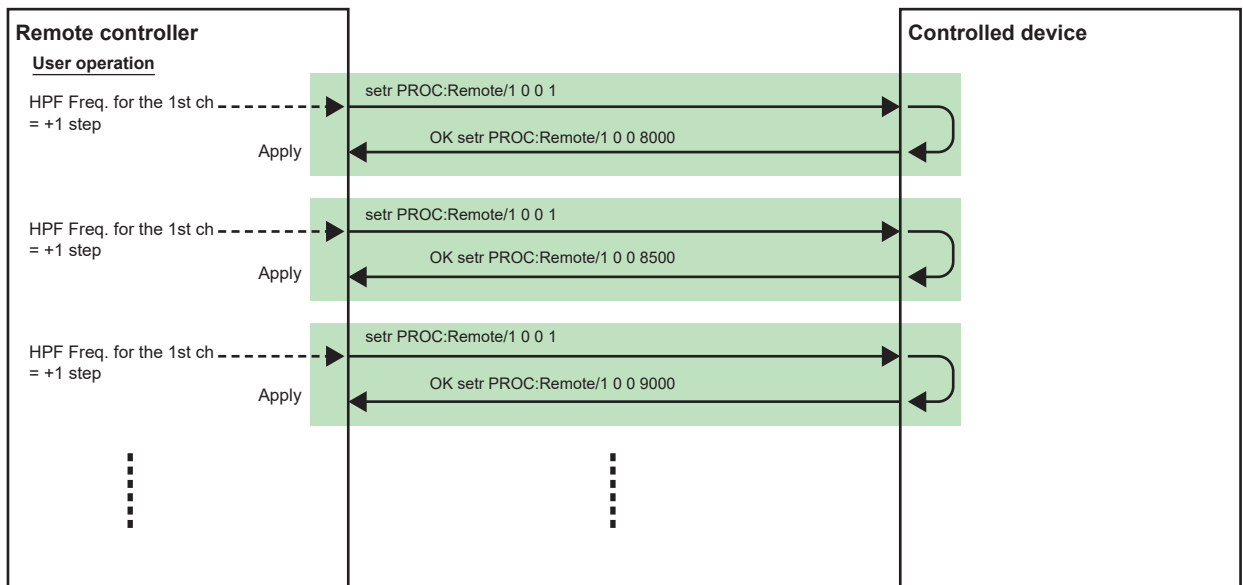

Edit box on GUI

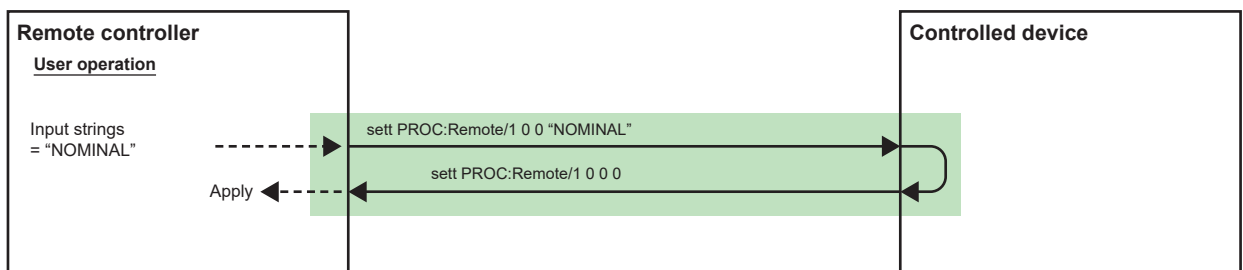

After the input strings are interpreted according to the algorithm defined by each device and the corresponding value is set, the result notification is returned. The controller uses the interpreted character string to re-apply it to the edit box.

4.5. Parameter query sequence at any given time

LEDs and displays on the GUI

Indications are updated on the basis of the result notifications returned after the processing of the set commands. Alternatively, send an explicit get request and apply the result to the indications, as shown below.

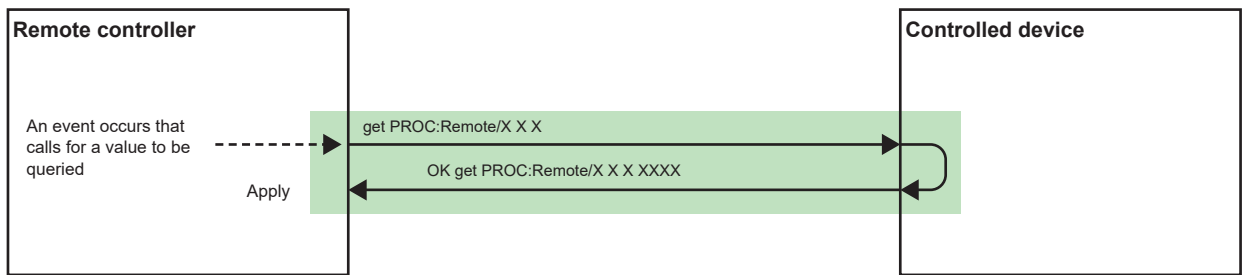

One example of using this sequence would be for refreshing the UI after boot-up or after changing tabs.

4.6. Meter data request/query sequence

The controller requests meter data by specifying the meter data address and the minimum transmission interval. The meter transmission stops after 10 seconds. To continue receiving data, make another request before the 10 seconds pass.

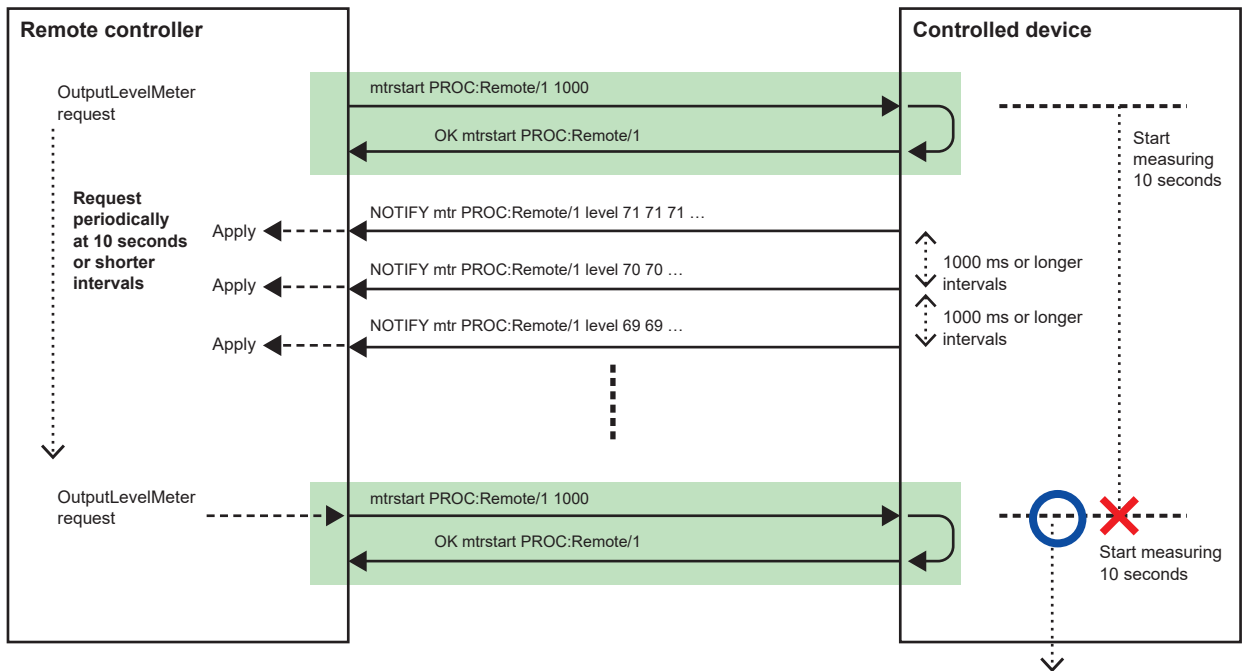

* Transmission for 10 seconds after a request
If another request is received, restart measuring the time.

4.7. Snapshot recall request sequence

Upon receiving a result notification in response to a Snapshot Recall request, you need to execute the parameter sync sequence.

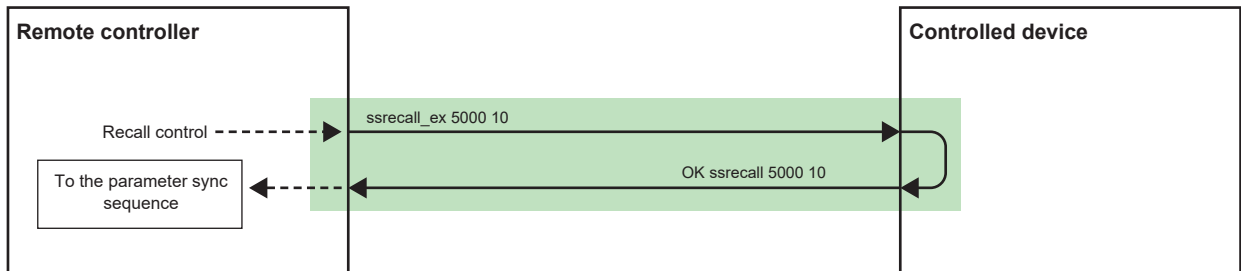

In addition, if a snapshot recall occurs internally in the controlled device (e.g. by front panel button press) or when such a request is returned from another controller, the controller receives a change notification that indicates that all parameters have changed (see the next section). If this occurs, the controller needs to execute the parameter sync sequence.

4.8. Sequence when parameters are changed by another controller

If parameters change due to the controlled device (DME7) or request from another controller, a parameter change notification is received asynchronously.

For changes made by the controller, a result notification for the request will be returned instead of a change notification.

Therefore, you can recognize if the change was made by the controller by checking the notification type: result or change notification. For changes along with other parameters changed by the controller, a change notification is returned.

The change notification is not returned every time a change is made but is sampled at certain intervals.

You will be notified of the first change immediately, but after the same parameters are operated repeatedly, the changes are notified at certain intervals.

The controller receiving a parameter change notification updates its own status if necessary.

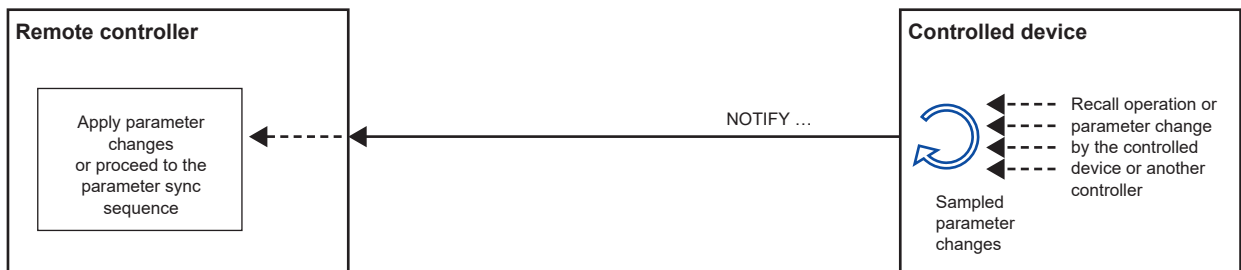

The way in which parameter change notifications are sent varies depending on the value notification mode specified in the control protocol mode.

If you want to handle a value with a given range, such as in a MIDI controller,

- Set the value notification mode to normalized value notification mode, and specify the required resolution.
- Use setn/getn to perform processing from the controller.
- Apply changes to the controller according to NOTIFY setn.

Conversely, for a highly functional PC application where you want to use all the internal parameters,

- Set the control protocol mode to raw value mode.
- Use set/get to perform processing from the controller.
- Apply changes to the controller according to NOTIFY set.
- Use setn/getn for certain parameters when necessary.

5. Meter Value

* The most significant bit indicates whether “Σ clip” exists, and the last 7 bits are interpreted as shown in the table below.

5.1. Level Meter, Hold Meter, GR Meter

Value	Data	Value	Data	Value	Data	Value	Data
00	-126dBFS or less	20	-94dBFS	40	-62dBFS	60	-30dBFS
01	-125dBFS	21	-93dBFS	41	-61dBFS	61	-29dBFS
02	-124dBFS	22	-92dBFS	42	-60dBFS	62	-28dBFS
03	-123dBFS	23	-91dBFS	43	-59dBFS	63	-27dBFS
04	-122dBFS	24	-90dBFS	44	-58dBFS	66	-26dBFS
05	-121dBFS	25	-89dBFS	45	-57dBFS	65	-25dBFS
06	-120dBFS	26	-88dBFS	46	-56dBFS	66	-24dBFS
07	-119dBFS	27	-87dBFS	47	-55dBFS	67	-23dBFS
08	-118dBFS	28	-86dBFS	48	-54dBFS	68	-22dBFS
09	-117dBFS	29	-85dBFS	49	-53dBFS	69	-21dBFS
0A	-116dBFS	2A	-84dBFS	4A	-52dBFS	6A	-20dBFS
0B	-115dBFS	2B	-83dBFS	4B	-51dBFS	6B	-19dBFS
0C	-114dBFS	2C	-82dBFS	4C	-50dBFS	6C	-18dBFS
0D	-113dBFS	2D	-81dBFS	4D	-49dBFS	6D	-17dBFS
0E	-112dBFS	2E	-80dBFS	4E	-48dBFS	6E	-16dBFS
0F	-111dBFS	2F	-79dBFS	4F	-47dBFS	6F	-15dBFS
10	-110dBFS	30	-78dBFS	50	-46dBFS	70	-14dBFS
11	-109dBFS	31	-77dBFS	51	-45dBFS	71	-13dBFS
12	-108dBFS	32	-76dBFS	52	-44dBFS	72	-12dBFS
13	-107dBFS	33	-75dBFS	55	-43dBFS	77	-11dBFS
14	-106dBFS	34	-74dBFS	54	-42dBFS	74	-10dBFS
15	-105dBFS	35	-73dBFS	55	-41dBFS	77	-9dBFS
16	-104dBFS	36	-72dBFS	56	-40dBFS	76	-8dBFS
17	-103dBFS	37	-71dBFS	57	-39dBFS	77	-7dBFS
18	-102dBFS	38	-70dBFS	58	-38dBFS	78	-6dBFS
19	-101dBFS	39	-69dBFS	59	-37dBFS	79	-5dBFS
1A	-100dBFS	3A	-68dBFS	5A	-36dBFS	7A	-4dBFS
1B	-99dBFS	3B	-67dBFS	5B	-35dBFS	7B	-3dBFS
1C	-98dBFS	3C	-66dBFS	5C	-34dBFS	7C	-2dBFS
1D	-97dBFS	3D	-65dBFS	5D	-33dBFS	7D	-1dBFS
1E	-96dBFS	3E	-64dBFS	5E	-32dBFS	7E	0dBFS
1F	-95dBFS	3F	-63dBFS	5F	-31dBFS	7F	OVER

NOTE: For the GR meter, 7F - FF are reserved.

NOTE: A device may not be able to send all the values depending on how precise the device processes values internally.

6. Parameter Value Details

6.1. Fader parameter

6.1.1. Fader with “-∞ to 0dB” range

Value	Data	Value	Data	Value	Data	Value	Data	Value	Data	Value	Data	Value	Data	Value	Data
0	-InfdB	64	-87.50dB	128	-69.00dB	192	-56.20dB	256	-46.70dB	320	-40.30dB	384	-33.90dB	448	-28.75dB
1	-138.00dB	65	-87.00dB	129	-68.80dB	193	-56.00dB	257	-46.60dB	321	-40.20dB	385	-33.80dB	449	-28.70dB
2	-136.00dB	66	-86.50dB	130	-68.60dB	194	-55.80dB	258	-46.50dB	322	-40.10dB	386	-33.70dB	450	-28.65dB
3	-134.00dB	67	-86.00dB	131	-68.40dB	195	-55.60dB	259	-46.40dB	323	-40.00dB	387	-33.60dB	451	-28.60dB
4	-133.00dB	68	-85.50dB	132	-68.20dB	196	-55.40dB	260	-46.30dB	324	-39.90dB	388	-33.50dB	452	-28.55dB
5	-132.00dB	69	-85.00dB	133	-68.00dB	197	-55.20dB	261	-46.20dB	325	-39.80dB	389	-33.40dB	453	-28.50dB
6	-131.00dB	70	-84.50dB	134	-67.80dB	198	-55.00dB	262	-46.10dB	326	-39.70dB	390	-33.30dB	454	-28.45dB
7	-130.00dB	71	-84.00dB	135	-67.60dB	199	-54.80dB	263	-46.00dB	327	-39.60dB	391	-33.20dB	455	-28.40dB
8	-129.00dB	72	-83.50dB	136	-67.40dB	200	-54.60dB	264	-45.90dB	328	-39.50dB	392	-33.10dB	456	-28.35dB
9	-128.00dB	73	-83.00dB	137	-67.20dB	201	-54.40dB	265	-45.80dB	329	-39.40dB	393	-33.00dB	457	-28.30dB
10	-127.00dB	74	-82.50dB	138	-67.00dB	202	-54.20dB	266	-45.70dB	330	-39.30dB	394	-32.90dB	458	-28.25dB
11	-126.00dB	75	-82.00dB	139	-66.80dB	203	-54.00dB	267	-45.60dB	331	-39.20dB	395	-32.80dB	459	-28.20dB
12	-125.00dB	76	-81.50dB	140	-66.60dB	204	-53.80dB	268	-45.50dB	332	-39.10dB	396	-32.70dB	460	-28.15dB
13	-124.00dB	77	-81.00dB	141	-66.40dB	205	-53.60dB	269	-45.40dB	333	-39.00dB	397	-32.60dB	461	-28.10dB
14	-123.00dB	78	-80.50dB	142	-66.20dB	206	-53.40dB	270	-45.30dB	334	-38.90dB	398	-32.50dB	462	-28.05dB
15	-122.00dB	79	-80.00dB	143	-66.00dB	207	-53.20dB	271	-45.20dB	335	-38.80dB	399	-32.40dB	463	-28.00dB
16	-121.00dB	80	-79.50dB	144	-65.80dB	208	-53.00dB	272	-45.10dB	336	-38.70dB	400	-32.30dB	464	-27.95dB
17	-120.00dB	81	-79.00dB	145	-65.60dB	209	-52.80dB	273	-45.00dB	337	-38.60dB	401	-32.20dB	465	-27.90dB
18	-119.00dB	82	-78.50dB	146	-65.40dB	210	-52.60dB	274	-44.90dB	338	-38.50dB	402	-32.10dB	466	-27.85dB
19	-118.00dB	83	-78.00dB	147	-65.20dB	211	-52.40dB	275	-44.80dB	339	-38.40dB	403	-32.00dB	467	-27.80dB
20	-117.00dB	84	-77.80dB	148	-65.00dB	212	-52.20dB	276	-44.70dB	340	-38.30dB	404	-31.90dB	468	-27.75dB
21	-116.00dB	85	-77.60dB	149	-64.80dB	213	-52.00dB	277	-44.60dB	341	-38.20dB	405	-31.80dB	469	-27.70dB
22	-115.00dB	86	-77.40dB	150	-64.60dB	214	-51.80dB	278	-44.50dB	342	-38.10dB	406	-31.70dB	470	-27.65dB
23	-114.00dB	87	-77.20dB	151	-64.40dB	215	-51.60dB	279	-44.40dB	343	-38.00dB	407	-31.60dB	471	-27.60dB
24	-113.00dB	88	-77.00dB	152	-64.20dB	216	-51.40dB	280	-44.30dB	344	-37.90dB	408	-31.50dB	472	-27.55dB
25	-112.00dB	89	-76.80dB	153	-64.00dB	217	-51.20dB	281	-44.20dB	345	-37.80dB	409	-31.40dB	473	-27.50dB
26	-111.00dB	90	-76.60dB	154	-63.80dB	218	-51.00dB	282	-44.10dB	346	-37.70dB	410	-31.30dB	474	-27.45dB
27	-110.00dB	91	-76.40dB	155	-63.60dB	219	-50.80dB	283	-44.00dB	347	-37.60dB	411	-31.20dB	475	-27.40dB
28	-109.00dB	92	-76.20dB	156	-63.40dB	220	-50.60dB	284	-43.90dB	348	-37.50dB	412	-31.10dB	476	-27.35dB
29	-108.00dB	93	-76.00dB	157	-63.20dB	221	-50.40dB	285	-43.80dB	349	-37.40dB	413	-31.00dB	477	-27.30dB
30	-107.00dB	94	-75.80dB	158	-63.00dB	222	-50.20dB	286	-43.70dB	350	-37.30dB	414	-30.90dB	478	-27.25dB
31	-106.00dB	95	-75.60dB	159	-62.80dB	223	-50.00dB	287	-43.60dB	351	-37.20dB	415	-30.80dB	479	-27.20dB
32	-105.00dB	96	-75.40dB	160	-62.60dB	224	-49.90dB	288	-43.50dB	352	-37.10dB	416	-30.70dB	480	-27.15dB
33	-104.00dB	97	-75.20dB	161	-62.40dB	225	-49.80dB	289	-43.40dB	353	-37.00dB	417	-30.60dB	481	-27.10dB
34	-103.00dB	98	-75.00dB	162	-62.20dB	226	-49.70dB	290	-43.30dB	354	-36.90dB	418	-30.50dB	482	-27.05dB
35	-102.00dB	99	-74.80dB	163	-62.00dB	227	-49.60dB	291	-43.20dB	355	-36.80dB	419	-30.40dB	483	-27.00dB
36	-101.50dB	100	-74.60dB	164	-61.80dB	228	-49.50dB	292	-43.10dB	356	-36.70dB	420	-30.30dB	484	-26.95dB
37	-101.00dB	101	-74.40dB	165	-61.60dB	229	-49.40dB	293	-43.00dB	357	-36.60dB	421	-30.20dB	485	-26.90dB
38	-100.50dB	102	-74.20dB	166	-61.40dB	230	-49.30dB	294	-42.90dB	358	-36.50dB	422	-30.10dB	486	-26.85dB
39	-100.00dB	103	-74.00dB	167	-61.20dB	231	-49.20dB	295	-42.80dB	359	-36.40dB	423	-30.00dB	487	-26.80dB
40	-99.50dB	104	-73.80dB	168	-61.00dB	232	-49.10dB	296	-42.70dB	360	-36.30dB	424	-29.95dB	488	-26.75dB
41	-99.00dB	105	-73.60dB	169	-60.80dB	233	-49.00dB	297	-42.60dB	361	-36.20dB	425	-29.90dB	489	-26.70dB
42	-98.50dB	106	-73.40dB	170	-60.60dB	234	-48.90dB	298	-42.50dB	362	-36.10dB	426	-29.85dB	490	-26.65dB
43	-98.00dB	107	-73.20dB	171	-60.40dB	235	-48.80dB	299	-42.40dB	363	-36.00dB	427	-29.80dB	491	-26.60dB
44	-97.50dB	108	-73.00dB	172	-60.20dB	236	-48.70dB	300	-42.30dB	364	-35.90dB	428	-29.75dB	492	-26.55dB
45	-97.00dB	109	-72.80dB	173	-60.00dB	237	-48.60dB	301	-42.20dB	365	-35.80dB	429	-29.70dB	493	-26.50dB
46	-96.50dB	110	-72.60dB	174	-59.80dB	238	-48.50dB	302	-42.10dB	366	-35.70dB	430	-29.65dB	494	-26.45dB
47	-96.00dB	111	-72.40dB	175	-59.60dB	239	-48.40dB	303	-42.00dB	367	-35.60dB	431	-29.60dB	495	-26.40dB
48	-95.50dB	112	-72.20dB	176	-59.40dB	240	-48.30dB	304	-41.90dB	368	-35.50dB	432	-29.55dB	496	-26.35dB
49	-95.00dB	113	-72.00dB	177	-59.20dB	241	-48.20dB	305	-41.80dB	369	-35.40dB	433	-29.50dB	497	-26.30dB
50	-94.50dB	114	-71.80dB	178	-59.00dB	242	-48.10dB	306	-41.70dB	370	-35.30dB	434	-29.45dB	498	-26.25dB
51	-94.00dB	115	-71.60dB	179	-58.80dB	243	-48.00dB	307	-41.60dB	371	-35.20dB	435	-29.40dB	499	-26.20dB
52	-93.50dB	116	-71.40dB	180	-58.60dB	244	-47.90dB	308	-41.50dB	372	-35.10dB	436	-29.35dB	500	-26.15dB
53	-93.00dB	117	-71.20dB	181	-58.40dB	245	-47.80dB	309	-41.40dB	373	-35.00dB	437	-29.30dB	501	-26.10dB
54	-92.50dB	118	-71.00dB	182	-58.20dB	246	-47.70dB	310	-41.30dB	374	-34.90dB	438	-29.25dB	502	-26.05dB
55	-92.00dB	119	-70.80dB	183	-58.00dB	247	-47.60dB	311	-41.20dB	375	-34.80dB	439	-29.20dB	503	-26.00dB
56	-91.50dB	120	-70.60dB	184	-57.80dB	248	-47.50dB	312	-41.10dB	376	-34.70dB	440	-29.15dB	504	-25.95dB
57	-91.00dB	121	-70.40dB	185	-57.60dB	249	-47.40dB	313	-41.00dB	377	-34.60dB	441	-29.10dB	505	-25.90dB
58	-90.50dB	122	-70.20dB	186	-57.40dB	250	-47.30dB	314	-40.90dB	378	-34.50dB	442	-29.05dB	506	-25.85dB
59	-90.00dB	123	-70.00dB	187	-57.20dB	251	-47.20dB	315	-40.80dB	379	-34.40dB	443	-29.00dB	507	-25.80dB
60	-89.50dB	124	-69.80dB	188	-57.00dB	252	-47.10dB	316	-40.70dB	380	-34.30dB	444	-28.95dB	508	-25.75dB
61	-89.00dB	125	-69.60dB	189	-56.80dB	253	-47.00dB	317	-40.60dB	381	-34.20dB	445	-28.90dB	509	-25.70dB
62	-88.50dB	126	-69.40dB	190	-56.60dB	254	-46.90dB	318	-40.50dB	382	-34.10dB	446	-28.85dB	510	-25.65dB
63	-88.00dB	127	-69.20dB	191	-56.40dB	255	-46.80dB	319	-40.40dB	383	-34.00dB	447	-28.80dB	511	-25.60dB

6. Parameter Value Details

Value	Data	Value	Data	Value	Data	Value	Data	Value	Data	Value	Data	Value	Data	Value	Data
512	-25.55dB	576	-22.35dB	640	-19.15dB	704	-15.95dB	768	-12.75dB	832	-9.55dB	896	-6.35dB	960	-3.15dB
513	-25.50dB	577	-22.30dB	641	-19.10dB	705	-15.90dB	769	-12.70dB	833	-9.50dB	897	-6.30dB	961	-3.10dB
514	-25.45dB	578	-22.25dB	642	-19.05dB	706	-15.85dB	770	-12.65dB	834	-9.45dB	898	-6.25dB	962	-3.05dB
515	-25.40dB	579	-22.20dB	643	-19.00dB	707	-15.80dB	771	-12.60dB	835	-9.40dB	899	-6.20dB	963	-3.00dB
516	-25.35dB	580	-22.15dB	644	-18.95dB	708	-15.75dB	772	-12.55dB	836	-9.35dB	900	-6.15dB	964	-2.95dB
517	-25.30dB	581	-22.10dB	645	-18.90dB	709	-15.70dB	773	-12.50dB	837	-9.30dB	901	-6.10dB	965	-2.90dB
518	-25.25dB	582	-22.05dB	646	-18.85dB	710	-15.65dB	774	-12.45dB	838	-9.25dB	902	-6.05dB	966	-2.85dB
519	-25.20dB	583	-22.00dB	647	-18.80dB	711	-15.60dB	775	-12.40dB	839	-9.20dB	903	-6.00dB	967	-2.80dB
520	-25.15dB	584	-21.95dB	648	-18.75dB	712	-15.55dB	776	-12.35dB	840	-9.15dB	904	-5.95dB	968	-2.75dB
521	-25.10dB	585	-21.90dB	649	-18.70dB	713	-15.50dB	777	-12.30dB	841	-9.10dB	905	-5.90dB	969	-2.70dB
522	-25.05dB	586	-21.85dB	650	-18.65dB	714	-15.45dB	778	-12.25dB	842	-9.05dB	906	-5.85dB	970	-2.65dB
523	-25.00dB	587	-21.80dB	651	-18.60dB	715	-15.40dB	779	-12.20dB	843	-9.00dB	907	-5.80dB	971	-2.60dB
524	-24.95dB	588	-21.75dB	652	-18.55dB	716	-15.35dB	780	-12.15dB	844	-8.95dB	908	-5.75dB	972	-2.55dB
525	-24.90dB	589	-21.70dB	653	-18.50dB	717	-15.30dB	781	-12.10dB	845	-8.90dB	909	-5.70dB	973	-2.50dB
526	-24.85dB	590	-21.65dB	654	-18.45dB	718	-15.25dB	782	-12.05dB	846	-8.85dB	910	-5.65dB	974	-2.45dB
527	-24.80dB	591	-21.60dB	655	-18.40dB	719	-15.20dB	783	-12.00dB	847	-8.80dB	911	-5.60dB	975	-2.40dB
528	-24.75dB	592	-21.55dB	656	-18.35dB	720	-15.15dB	784	-11.95dB	848	-8.75dB	912	-5.55dB	976	-2.35dB
529	-24.70dB	593	-21.50dB	657	-18.30dB	721	-15.10dB	785	-11.90dB	849	-8.70dB	913	-5.50dB	977	-2.30dB
530	-24.65dB	594	-21.45dB	658	-18.25dB	722	-15.05dB	786	-11.85dB	850	-8.65dB	914	-5.45dB	978	-2.25dB
531	-24.60dB	595	-21.40dB	659	-18.20dB	723	-15.00dB	787	-11.80dB	851	-8.60dB	915	-5.40dB	979	-2.20dB
532	-24.55dB	596	-21.35dB	660	-18.15dB	724	-14.95dB	788	-11.75dB	852	-8.55dB	916	-5.35dB	980	-2.15dB
533	-24.50dB	597	-21.30dB	661	-18.10dB	725	-14.90dB	789	-11.70dB	853	-8.50dB	917	-5.30dB	981	-2.10dB
534	-24.45dB	598	-21.25dB	662	-18.05dB	726	-14.85dB	790	-11.65dB	854	-8.45dB	918	-5.25dB	982	-2.05dB
535	-24.40dB	599	-21.20dB	663	-18.00dB	727	-14.80dB	791	-11.60dB	855	-8.40dB	919	-5.20dB	983	-2.00dB
536	-24.35dB	600	-21.15dB	664	-17.95dB	728	-14.75dB	792	-11.55dB	856	-8.35dB	920	-5.15dB	984	-1.95dB
537	-24.30dB	601	-21.10dB	665	-17.90dB	729	-14.70dB	793	-11.50dB	857	-8.30dB	921	-5.10dB	985	-1.90dB
538	-24.25dB	602	-21.05dB	666	-17.85dB	730	-14.65dB	794	-11.45dB	858	-8.25dB	922	-5.05dB	986	-1.85dB
539	-24.20dB	603	-21.00dB	667	-17.80dB	731	-14.60dB	795	-11.40dB	859	-8.20dB	923	-5.00dB	987	-1.80dB
540	-24.15dB	604	-20.95dB	668	-17.75dB	732	-14.55dB	796	-11.35dB	860	-8.15dB	924	-4.95dB	988	-1.75dB
541	-24.10dB	605	-20.90dB	669	-17.70dB	733	-14.50dB	797	-11.30dB	861	-8.10dB	925	-4.90dB	989	-1.70dB
542	-24.05dB	606	-20.85dB	670	-17.65dB	734	-14.45dB	798	-11.25dB	862	-8.05dB	926	-4.85dB	990	-1.65dB
543	-24.00dB	607	-20.80dB	671	-17.60dB	735	-14.40dB	799	-11.20dB	863	-8.00dB	927	-4.80dB	991	-1.60dB
544	-23.95dB	608	-20.75dB	672	-17.55dB	736	-14.35dB	800	-11.15dB	864	-7.95dB	928	-4.75dB	992	-1.55dB
545	-23.90dB	609	-20.70dB	673	-17.50dB	737	-14.30dB	801	-11.10dB	865	-7.90dB	929	-4.70dB	993	-1.50dB
546	-23.85dB	610	-20.65dB	674	-17.45dB	738	-14.25dB	802	-11.05dB	866	-7.85dB	930	-4.65dB	994	-1.45dB
547	-23.80dB	611	-20.60dB	675	-17.40dB	739	-14.20dB	803	-11.00dB	867	-7.80dB	931	-4.60dB	995	-1.40dB
548	-23.75dB	612	-20.55dB	676	-17.35dB	740	-14.15dB	804	-10.95dB	868	-7.75dB	932	-4.55dB	996	-1.35dB
549	-23.70dB	613	-20.50dB	677	-17.30dB	741	-14.10dB	805	-10.90dB	869	-7.70dB	933	-4.50dB	997	-1.30dB
550	-23.65dB	614	-20.45dB	678	-17.25dB	742	-14.05dB	806	-10.85dB	870	-7.65dB	934	-4.45dB	998	-1.25dB
551	-23.60dB	615	-20.40dB	679	-17.20dB	743	-14.00dB	807	-10.80dB	871	-7.60dB	935	-4.40dB	999	-1.20dB
552	-23.55dB	616	-20.35dB	680	-17.15dB	744	-13.95dB	808	-10.75dB	872	-7.55dB	936	-4.35dB	1000	-1.15dB
553	-23.50dB	617	-20.30dB	681	-17.10dB	745	-13.90dB	809	-10.70dB	873	-7.50dB	937	-4.30dB	1001	-1.10dB
554	-23.45dB	618	-20.25dB	682	-17.05dB	746	-13.85dB	810	-10.65dB	874	-7.45dB	938	-4.25dB	1002	-1.05dB
555	-23.40dB	619	-20.20dB	683	-17.00dB	747	-13.80dB	811	-10.60dB	875	-7.40dB	939	-4.20dB	1003	-1.00dB
556	-23.35dB	620	-20.15dB	684	-16.95dB	748	-13.75dB	812	-10.55dB	876	-7.35dB	940	-4.15dB	1004	-0.95dB
557	-23.30dB	621	-20.10dB	685	-16.90dB	749	-13.70dB	813	-10.50dB	877	-7.30dB	941	-4.10dB	1005	-0.90dB
558	-23.25dB	622	-20.05dB	686	-16.85dB	750	-13.65dB	814	-10.45dB	878	-7.25dB	942	-4.05dB	1006	-0.85dB
559	-23.20dB	623	-20.00dB	687	-16.80dB	751	-13.60dB	815	-10.40dB	879	-7.20dB	943	-4.00dB	1007	-0.80dB
560	-23.15dB	624	-19.95dB	688	-16.75dB	752	-13.55dB	816	-10.35dB	880	-7.15dB	944	-3.95dB	1008	-0.75dB
561	-23.10dB	625	-19.90dB	689	-16.70dB	753	-13.50dB	817	-10.30dB	881	-7.10dB	945	-3.90dB	1009	-0.70dB
562	-23.05dB	626	-19.85dB	690	-16.65dB	754	-13.45dB	818	-10.25dB	882	-7.05dB	946	-3.85dB	1010	-0.65dB
563	-23.00dB	627	-19.80dB	691	-16.60dB	755	-13.40dB	819	-10.20dB	883	-7.00dB	947	-3.80dB	1011	-0.60dB
564	-22.95dB	628	-19.75dB	692	-16.55dB	756	-13.35dB	820	-10.15dB	884	-6.95dB	948	-3.75dB	1012	-0.55dB
565	-22.90dB	629	-19.70dB	693	-16.50dB	757	-13.30dB	821	-10.10dB	885	-6.90dB	949	-3.70dB	1013	-0.50dB
566	-22.85dB	630	-19.65dB	694	-16.45dB	758	-13.25dB	822	-10.05dB	886	-6.85dB	950	-3.65dB	1014	-0.45dB
567	-22.80dB	631	-19.60dB	695	-16.40dB	759	-13.20dB	823	-10.00dB	887	-6.80dB	951	-3.60dB	1015	-0.40dB
568	-22.75dB	632	-19.55dB	696	-16.35dB	760	-13.15dB	824	-9.95dB	888	-6.75dB	952	-3.55dB	1016	-0.35dB
569	-22.70dB	633	-19.50dB	697	-16.30dB	761	-13.10dB	825	-9.90dB	889	-6.70dB	953	-3.50dB	1017	-0.30dB
570	-22.65dB	634	-19.45dB	698	-16.25dB	762	-13.05dB	826	-9.85dB	890	-6.65dB	954	-3.45dB	1018	-0.25dB
571	-22.60dB	635	-19.40dB	699	-16.20dB	763	-13.00dB	827	-9.80dB	891	-6.60dB	955	-3.40dB	1019	-0.20dB
572	-22.55dB	636	-19.35dB	700	-16.15dB	764	-12.95dB	828	-9.75dB	892	-6.55dB	956	-3.35dB	1020	-0.15dB
573	-22.50dB	637	-19.30dB	701	-16.10dB	765	-12.90dB	829	-9.70dB	893	-6.50dB	957	-3.30dB	1021	-0.10dB
574	-22.45dB	638	-19.25dB	702	-16.05dB	766	-12.85dB	830	-9.65dB	894	-6.45dB	958	-3.25dB	1022	-0.05dB
575	-22.40dB	639	-19.20dB	703	-16.00dB	767	-12.80dB	831	-9.60dB	895	-6.40dB	959	-3.20dB	1023	0.00dB

6.1.2. Fader with “-∞ to 10dB” range

Value	Data	Value	Data	Value	Data	Value	Data	Value	Data	Value	Data	Value	Data	Value	Data
0	-InfdB	64	-71.80dB	128	-59.00dB	192	-46.20dB	256	-36.70dB	320	-30.30dB	384	-23.90dB	448	-18.75dB
1	-138.00dB	65	-71.60dB	129	-58.80dB	193	-46.00dB	257	-36.60dB	321	-30.20dB	385	-23.80dB	449	-18.70dB
2	-135.00dB	66	-71.40dB	130	-58.60dB	194	-45.80dB	258	-36.50dB	322	-30.10dB	386	-23.70dB	450	-18.65dB
3	-132.00dB	67	-71.20dB	131	-58.40dB	195	-45.60dB	259	-36.40dB	323	-30.00dB	387	-23.60dB	451	-18.60dB
4	-129.00dB	68	-71.00dB	132	-58.20dB	196	-45.40dB	260	-36.30dB	324	-29.90dB	388	-23.50dB	452	-18.55dB
5	-126.00dB	69	-70.80dB	133	-58.00dB	197	-45.20dB	261	-36.20dB	325	-29.80dB	389	-23.40dB	453	-18.50dB
6	-123.00dB	70	-70.60dB	134	-57.80dB	198	-45.00dB	262	-36.10dB	326	-29.70dB	390	-23.30dB	454	-18.45dB
7	-120.00dB	71	-70.40dB	135	-57.60dB	199	-44.80dB	263	-36.00dB	327	-29.60dB	391	-23.20dB	455	-18.40dB
8	-117.00dB	72	-70.20dB	136	-57.40dB	200	-44.60dB	264	-35.90dB	328	-29.50dB	392	-23.10dB	456	-18.35dB
9	-114.00dB	73	-70.00dB	137	-57.20dB	201	-44.40dB	265	-35.80dB	329	-29.40dB	393	-23.00dB	457	-18.30dB
10	-111.00dB	74	-69.80dB	138	-57.00dB	202	-44.20dB	266	-35.70dB	330	-29.30dB	394	-22.90dB	458	-18.25dB
11	-108.00dB	75	-69.60dB	139	-56.80dB	203	-44.00dB	267	-35.60dB	331	-29.20dB	395	-22.80dB	459	-18.20dB
12	-105.00dB	76	-69.40dB	140	-56.60dB	204	-43.80dB	268	-35.50dB	332	-29.10dB	396	-22.70dB	460	-18.15dB
13	-102.00dB	77	-69.20dB	141	-56.40dB	205	-43.60dB	269	-35.40dB	333	-29.00dB	397	-22.60dB	461	-18.10dB
14	-99.00dB	78	-69.00dB	142	-56.20dB	206	-43.40dB	270	-35.30dB	334	-28.90dB	398	-22.50dB	462	-18.05dB
15	-96.00dB	79	-68.80dB	143	-56.00dB	207	-43.20dB	271	-35.20dB	335	-28.80dB	399	-22.40dB	463	-18.00dB
16	-95.00dB	80	-68.60dB	144	-55.80dB	208	-43.00dB	272	-35.10dB	336	-28.70dB	400	-22.30dB	464	-17.95dB
17	-94.00dB	81	-68.40dB	145	-55.60dB	209	-42.80dB	273	-35.00dB	337	-28.60dB	401	-22.20dB	465	-17.90dB
18	-93.00dB	82	-68.20dB	146	-55.40dB	210	-42.60dB	274	-34.90dB	338	-28.50dB	402	-22.10dB	466	-17.85dB
19	-92.00dB	83	-68.00dB	147	-55.20dB	211	-42.40dB	275	-34.80dB	339	-28.40dB	403	-22.00dB	467	-17.80dB
20	-91.00dB	84	-67.80dB	148	-55.00dB	212	-42.20dB	276	-34.70dB	340	-28.30dB	404	-21.90dB	468	-17.75dB
21	-90.00dB	85	-67.60dB	149	-54.80dB	213	-42.00dB	277	-34.60dB	341	-28.20dB	405	-21.80dB	469	-17.70dB
22	-89.00dB	86	-67.40dB	150	-54.60dB	214	-41.80dB	278	-34.50dB	342	-28.10dB	406	-21.70dB	470	-17.65dB
23	-88.00dB	87	-67.20dB	151	-54.40dB	215	-41.60dB	279	-34.40dB	343	-28.00dB	407	-21.60dB	471	-17.60dB
24	-87.00dB	88	-67.00dB	152	-54.20dB	216	-41.40dB	280	-34.30dB	344	-27.90dB	408	-21.50dB	472	-17.55dB
25	-86.00dB	89	-66.80dB	153	-54.00dB	217	-41.20dB	281	-34.20dB	345	-27.80dB	409	-21.40dB	473	-17.50dB
26	-85.00dB	90	-66.60dB	154	-53.80dB	218	-41.00dB	282	-34.10dB	346	-27.70dB	410	-21.30dB	474	-17.45dB
27	-84.00dB	91	-66.40dB	155	-53.60dB	219	-40.80dB	283	-34.00dB	347	-27.60dB	411	-21.20dB	475	-17.40dB
28	-83.00dB	92	-66.20dB	156	-53.40dB	220	-40.60dB	284	-33.90dB	348	-27.50dB	412	-21.10dB	476	-17.35dB
29	-82.00dB	93	-66.00dB	157	-53.20dB	221	-40.40dB	285	-33.80dB	349	-27.40dB	413	-21.00dB	477	-17.30dB
30	-81.00dB	94	-65.80dB	158	-53.00dB	222	-40.20dB	286	-33.70dB	350	-27.30dB	414	-20.90dB	478	-17.25dB
31	-80.00dB	95	-65.60dB	159	-52.80dB	223	-40.00dB	287	-33.60dB	351	-27.20dB	415	-20.80dB	479	-17.20dB
32	-79.00dB	96	-65.40dB	160	-52.60dB	224	-39.90dB	288	-33.50dB	352	-27.10dB	416	-20.70dB	480	-17.15dB
33	-78.00dB	97	-65.20dB	161	-52.40dB	225	-39.80dB	289	-33.40dB	353	-27.00dB	417	-20.60dB	481	-17.10dB
34	-77.80dB	98	-65.00dB	162	-52.20dB	226	-39.70dB	290	-33.30dB	354	-26.90dB	418	-20.50dB	482	-17.05dB
35	-77.60dB	99	-64.80dB	163	-52.00dB	227	-39.60dB	291	-33.20dB	355	-26.80dB	419	-20.40dB	483	-17.00dB
36	-77.40dB	100	-64.60dB	164	-51.80dB	228	-39.50dB	292	-33.10dB	356	-26.70dB	420	-20.30dB	484	-16.95dB
37	-77.20dB	101	-64.40dB	165	-51.60dB	229	-39.40dB	293	-33.00dB	357	-26.60dB	421	-20.20dB	485	-16.90dB
38	-77.00dB	102	-64.20dB	166	-51.40dB	230	-39.30dB	294	-32.90dB	358	-26.50dB	422	-20.10dB	486	-16.85dB
39	-76.80dB	103	-64.00dB	167	-51.20dB	231	-39.20dB	295	-32.80dB	359	-26.40dB	423	-20.00dB	487	-16.80dB
40	-76.60dB	104	-63.80dB	168	-51.00dB	232	-39.10dB	296	-32.70dB	360	-26.30dB	424	-19.95dB	488	-16.75dB
41	-76.40dB	105	-63.60dB	169	-50.80dB	233	-39.00dB	297	-32.60dB	361	-26.20dB	425	-19.90dB	489	-16.70dB
42	-76.20dB	106	-63.40dB	170	-50.60dB	234	-38.90dB	298	-32.50dB	362	-26.10dB	426	-19.85dB	490	-16.65dB
43	-76.00dB	107	-63.20dB	171	-50.40dB	235	-38.80dB	299	-32.40dB	363	-26.00dB	427	-19.80dB	491	-16.60dB
44	-75.80dB	108	-63.00dB	172	-50.20dB	236	-38.70dB	300	-32.30dB	364	-25.90dB	428	-19.75dB	492	-16.55dB
45	-75.60dB	109	-62.80dB	173	-50.00dB	237	-38.60dB	301	-32.20dB	365	-25.80dB	429	-19.70dB	493	-16.50dB
46	-75.40dB	110	-62.60dB	174	-49.80dB	238	-38.50dB	302	-32.10dB	366	-25.70dB	430	-19.65dB	494	-16.45dB
47	-75.20dB	111	-62.40dB	175	-49.60dB	239	-38.40dB	303	-32.00dB	367	-25.60dB	431	-19.60dB	495	-16.40dB
48	-75.00dB	112	-62.20dB	176	-49.40dB	240	-38.30dB	304	-31.90dB	368	-25.50dB	432	-19.55dB	496	-16.35dB
49	-74.80dB	113	-62.00dB	177	-49.20dB	241	-38.20dB	305	-31.80dB	369	-25.40dB	433	-19.50dB	497	-16.30dB
50	-74.60dB	114	-61.80dB	178	-49.00dB	242	-38.10dB	306	-31.70dB	370	-25.30dB	434	-19.45dB	498	-16.25dB
51	-74.40dB	115	-61.60dB	179	-48.80dB	243	-38.00dB	307	-31.60dB	371	-25.20dB	435	-19.40dB	499	-16.20dB
52	-74.20dB	116	-61.40dB	180	-48.60dB	244	-37.90dB	308	-31.50dB	372	-25.10dB	436	-19.35dB	500	-16.15dB
53	-74.00dB	117	-61.20dB	181	-48.40dB	245	-37.80dB	309	-31.40dB	373	-25.00dB	437	-19.30dB	501	-16.10dB
54	-73.80dB	118	-61.00dB	182	-48.20dB	246	-37.70dB	310	-31.30dB	374	-24.90dB	438	-19.25dB	502	-16.05dB
55	-73.60dB	119	-60.80dB	183	-48.00dB	247	-37.60dB	311	-31.20dB	375	-24.80dB	439	-19.20dB	503	-16.00dB
56	-73.40dB	120	-60.60dB	184	-47.80dB	248	-37.50dB	312	-31.10dB	376	-24.70dB	440	-19.15dB	504	-15.95dB
57	-73.20dB	121	-60.40dB	185	-47.60dB	249	-37.40dB	313	-31.00dB	377	-24.60dB	441	-19.10dB	505	-15.90dB
58	-73.00dB	122	-60.20dB	186	-47.40dB	250	-37.30dB	314	-30.90dB	378	-24.50dB	442	-19.05dB	506	-15.85dB
59	-72.80dB	123	-60.00dB	187	-47.20dB	251	-37.20dB	315	-30.80dB	379	-24.40dB	443	-19.00dB	507	-15.80dB
60	-72.60dB	124	-59.80dB	188	-47.00dB	252	-37.10dB	316	-30.70dB	380	-24.30dB	444	-18.95dB	508	-15.75dB
61	-72.40dB	125	-59.60dB	189	-46.80dB	253	-37.00dB	317	-30.60dB	381	-24.20dB	445	-18.90dB	509	-15.70dB
62	-72.20dB	126	-59.40dB	190	-46.60dB	254	-36.90dB	318	-30.50dB	382	-24.10dB	446	-18.85dB	510	-15.65dB
63	-72.00dB	127	-59.20dB	191	-46.40dB	255	-36.80dB	319	-30.40dB	383	-24.00dB	447	-18.80dB	511	-15.60dB

6. Parameter Value Details

Value	Data	Value	Data	Value	Data	Value	Data	Value	Data	Value	Data	Value	Data	Value	Data
512	-15.55dB	576	-12.35dB	640	-9.15dB	704	-5.95dB	768	-2.75dB	832	0.45dB	896	3.65dB	960	6.85dB
513	-15.50dB	577	-12.30dB	641	-9.10dB	705	-5.90dB	769	-2.70dB	833	0.50dB	897	3.70dB	961	6.90dB
514	-15.45dB	578	-12.25dB	642	-9.05dB	706	-5.85dB	770	-2.65dB	834	0.55dB	898	3.75dB	962	6.95dB
515	-15.40dB	579	-12.20dB	643	-9.00dB	707	-5.80dB	771	-2.60dB	835	0.60dB	899	3.80dB	963	7.00dB
516	-15.35dB	580	-12.15dB	644	-8.95dB	708	-5.75dB	772	-2.55dB	836	0.65dB	900	3.85dB	964	7.05dB
517	-15.30dB	581	-12.10dB	645	-8.90dB	709	-5.70dB	773	-2.50dB	837	0.70dB	901	3.90dB	965	7.10dB
518	-15.25dB	582	-12.05dB	646	-8.85dB	710	-5.65dB	774	-2.45dB	838	0.75dB	902	3.95dB	966	7.15dB
519	-15.20dB	583	-12.00dB	647	-8.80dB	711	-5.60dB	775	-2.40dB	839	0.80dB	903	4.00dB	967	7.20dB
520	-15.15dB	584	-11.95dB	648	-8.75dB	712	-5.55dB	776	-2.35dB	840	0.85dB	904	4.05dB	968	7.25dB
521	-15.10dB	585	-11.90dB	649	-8.70dB	713	-5.50dB	777	-2.30dB	841	0.90dB	905	4.10dB	969	7.30dB
522	-15.05dB	586	-11.85dB	650	-8.65dB	714	-5.45dB	778	-2.25dB	842	0.95dB	906	4.15dB	970	7.35dB
523	-15.00dB	587	-11.80dB	651	-8.60dB	715	-5.40dB	779	-2.20dB	843	1.00dB	907	4.20dB	971	7.40dB
524	-14.95dB	588	-11.75dB	652	-8.55dB	716	-5.35dB	780	-2.15dB	844	1.05dB	908	4.25dB	972	7.45dB
525	-14.90dB	589	-11.70dB	653	-8.50dB	717	-5.30dB	781	-2.10dB	845	1.10dB	909	4.30dB	973	7.50dB
526	-14.85dB	590	-11.65dB	654	-8.45dB	718	-5.25dB	782	-2.05dB	846	1.15dB	910	4.35dB	974	7.55dB
527	-14.80dB	591	-11.60dB	655	-8.40dB	719	-5.20dB	783	-2.00dB	847	1.20dB	911	4.40dB	975	7.60dB
528	-14.75dB	592	-11.55dB	656	-8.35dB	720	-5.15dB	784	-1.95dB	848	1.25dB	912	4.45dB	976	7.65dB
529	-14.70dB	593	-11.50dB	657	-8.30dB	721	-5.10dB	785	-1.90dB	849	1.30dB	913	4.50dB	977	7.70dB
530	-14.65dB	594	-11.45dB	658	-8.25dB	722	-5.05dB	786	-1.85dB	850	1.35dB	914	4.55dB	978	7.75dB
531	-14.60dB	595	-11.40dB	659	-8.20dB	723	-5.00dB	787	-1.80dB	851	1.40dB	915	4.60dB	979	7.80dB
532	-14.55dB	596	-11.35dB	660	-8.15dB	724	-4.95dB	788	-1.75dB	852	1.45dB	916	4.65dB	980	7.85dB
533	-14.50dB	597	-11.30dB	661	-8.10dB	725	-4.90dB	789	-1.70dB	853	1.50dB	917	4.70dB	981	7.90dB
534	-14.45dB	598	-11.25dB	662	-8.05dB	726	-4.85dB	790	-1.65dB	854	1.55dB	918	4.75dB	982	7.95dB
535	-14.40dB	599	-11.20dB	663	-8.00dB	727	-4.80dB	791	-1.60dB	855	1.60dB	919	4.80dB	983	8.00dB
536	-14.35dB	600	-11.15dB	664	-7.95dB	728	-4.75dB	792	-1.55dB	856	1.65dB	920	4.85dB	984	8.05dB
537	-14.30dB	601	-11.10dB	665	-7.90dB	729	-4.70dB	793	-1.50dB	857	1.70dB	921	4.90dB	985	8.10dB
538	-14.25dB	602	-11.05dB	666	-7.85dB	730	-4.65dB	794	-1.45dB	858	1.75dB	922	4.95dB	986	8.15dB
539	-14.20dB	603	-11.00dB	667	-7.80dB	731	-4.60dB	795	-1.40dB	859	1.80dB	923	5.00dB	987	8.20dB
540	-14.15dB	604	-10.95dB	668	-7.75dB	732	-4.55dB	796	-1.35dB	860	1.85dB	924	5.05dB	988	8.25dB
541	-14.10dB	605	-10.90dB	669	-7.70dB	733	-4.50dB	797	-1.30dB	861	1.90dB	925	5.10dB	989	8.30dB
542	-14.05dB	606	-10.85dB	670	-7.65dB	734	-4.45dB	798	-1.25dB	862	1.95dB	926	5.15dB	990	8.35dB
543	-14.00dB	607	-10.80dB	671	-7.60dB	735	-4.40dB	799	-1.20dB	863	2.00dB	927	5.20dB	991	8.40dB
544	-13.95dB	608	-10.75dB	672	-7.55dB	736	-4.35dB	800	-1.15dB	864	2.05dB	928	5.25dB	992	8.45dB
545	-13.90dB	609	-10.70dB	673	-7.50dB	737	-4.30dB	801	-1.10dB	865	2.10dB	929	5.30dB	993	8.50dB
546	-13.85dB	610	-10.65dB	674	-7.45dB	738	-4.25dB	802	-1.05dB	866	2.15dB	930	5.35dB	994	8.55dB
547	-13.80dB	611	-10.60dB	675	-7.40dB	739	-4.20dB	803	-1.00dB	867	2.20dB	931	5.40dB	995	8.60dB
548	-13.75dB	612	-10.55dB	676	-7.35dB	740	-4.15dB	804	-0.95dB	868	2.25dB	932	5.45dB	996	8.65dB
549	-13.70dB	613	-10.50dB	677	-7.30dB	741	-4.10dB	805	-0.90dB	869	2.30dB	933	5.50dB	997	8.70dB
550	-13.65dB	614	-10.45dB	678	-7.25dB	742	-4.05dB	806	-0.85dB	870	2.35dB	934	5.55dB	998	8.75dB
551	-13.60dB	615	-10.40dB	679	-7.20dB	743	-4.00dB	807	-0.80dB	871	2.40dB	935	5.60dB	999	8.80dB
552	-13.55dB	616	-10.35dB	680	-7.15dB	744	-3.95dB	808	-0.75dB	872	2.45dB	936	5.65dB	1000	8.85dB
553	-13.50dB	617	-10.30dB	681	-7.10dB	745	-3.90dB	809	-0.70dB	873	2.50dB	937	5.70dB	1001	8.90dB
554	-13.45dB	618	-10.25dB	682	-7.05dB	746	-3.85dB	810	-0.65dB	874	2.55dB	938	5.75dB	1002	8.95dB
555	-13.40dB	619	-10.20dB	683	-7.00dB	747	-3.80dB	811	-0.60dB	875	2.60dB	939	5.80dB	1003	9.00dB
556	-13.35dB	620	-10.15dB	684	-6.95dB	748	-3.75dB	812	-0.55dB	876	2.65dB	940	5.85dB	1004	9.05dB
557	-13.30dB	621	-10.10dB	685	-6.90dB	749	-3.70dB	813	-0.50dB	877	2.70dB	941	5.90dB	1005	9.10dB
558	-13.25dB	622	-10.05dB	686	-6.85dB	750	-3.65dB	814	-0.45dB	878	2.75dB	942	5.95dB	1006	9.15dB
559	-13.20dB	623	-10.00dB	687	-6.80dB	751	-3.60dB	815	-0.40dB	879	2.80dB	943	6.00dB	1007	9.20dB
560	-13.15dB	624	-9.95dB	688	-6.75dB	752	-3.55dB	816	-0.35dB	880	2.85dB	944	6.05dB	1008	9.25dB
561	-13.10dB	625	-9.90dB	689	-6.70dB	753	-3.50dB	817	-0.30dB	881	2.90dB	945	6.10dB	1009	9.30dB
562	-13.05dB	626	-9.85dB	690	-6.65dB	754	-3.45dB	818	-0.25dB	882	2.95dB	946	6.15dB	1010	9.35dB
563	-13.00dB	627	-9.80dB	691	-6.60dB	755	-3.40dB	819	-0.20dB	883	3.00dB	947	6.20dB	1011	9.40dB
564	-12.95dB	628	-9.75dB	692	-6.55dB	756	-3.35dB	820	-0.15dB	884	3.05dB	948	6.25dB	1012	9.45dB
565	-12.90dB	629	-9.70dB	693	-6.50dB	757	-3.30dB	821	-0.10dB	885	3.10dB	949	6.30dB	1013	9.50dB
566	-12.85dB	630	-9.65dB	694	-6.45dB	758	-3.25dB	822	-0.05dB	886	3.15dB	950	6.35dB	1014	9.55dB
567	-12.80dB	631	-9.60dB	695	-6.40dB	759	-3.20dB	823	0.00dB	887	3.20dB	951	6.40dB	1015	9.60dB
568	-12.75dB	632	-9.55dB	696	-6.35dB	760	-3.15dB	824	0.05dB	888	3.25dB	952	6.45dB	1016	9.65dB
569	-12.70dB	633	-9.50dB	697	-6.30dB	761	-3.10dB	825	0.10dB	889	3.30dB	953	6.50dB	1017	9.70dB
570	-12.65dB	634	-9.45dB	698	-6.25dB	762	-3.05dB	826	0.15dB	890	3.35dB	954	6.55dB	1018	9.75dB
571	-12.60dB	635	-9.40dB	699	-6.20dB	763	-3.00dB	827	0.20dB	891	3.40dB	955	6.60dB	1019	9.80dB
572	-12.55dB	636	-9.35dB	700	-6.15dB	764	-2.95dB	828	0.25dB	892	3.45dB	956	6.65dB	1020	9.85dB
573	-12.50dB	637	-9.30dB	701	-6.10dB	765	-2.90dB	829	0.30dB	893	3.50dB	957	6.70dB	1021	9.90dB
574	-12.45dB	638	-9.25dB	702	-6.05dB	766	-2.85dB	830	0.35dB	894	3.55dB	958	6.75dB	1022	9.95dB
575	-12.40dB	639	-9.20dB	703	-6.00dB	767	-2.80dB	831	0.40dB	895	3.60dB	959	6.80dB	1023	10.00dB

6.2. Other parameters

6.2.1. Ambient Noise Compensator

ANC Ratio

Value	Display
5	0.5:1
6	0.6:1
7	0.7:1
8	0.8:1
9	0.9:1
10	1.0:1
11	1.1:1
12	1.2:1
13	1.3:1
14	1.4:1
15	1.5:1
16	1.6:1
17	1.7:1
18	1.8:1
19	1.9:1
20	2.0:1

6.2.2. Auto Gain Control

Response Time

Value	Display	Value	Display
0	100msec	30	2.20sec
1	150msec	31	2.30sec
2	200msec	32	2.40sec
3	250msec	33	2.50sec
4	300msec	34	2.60sec
5	350msec	35	2.70sec
6	400msec	36	2.80sec
7	450msec	37	2.90sec
8	500msec	38	3.00sec
9	550msec	39	3.10sec
10	600msec	40	3.20sec
11	650msec	41	3.30sec
12	700msec	42	3.40sec
13	750msec	43	3.50sec
14	800msec	44	3.60sec
15	850msec	45	3.70sec
16	900msec	46	3.80sec
17	950msec	47	3.90sec
18	1.00sec	48	4.00sec
19	1.10sec	49	4.10sec
20	1.20sec	50	4.20sec
21	1.30sec	51	4.30sec
22	1.40sec	52	4.40sec
23	1.50sec	53	4.50sec
24	1.60sec	54	4.60sec
25	1.70sec	55	4.70sec
26	1.80sec	56	4.80sec
27	1.90sec	57	4.90sec
28	2.00sec	58	5.00sec
29	2.10sec		

6.2.3. Combiner

6.2.3.1. Room Combiner / Room Combiner plus Automixer

Source

Value	Display
0	BGM1
1	BGM2
2	BGM3
3	BGM4

Mode

Value	Display
0	Mute
1	Man
2	Auto

Weight

Value	Display
-3000	-100.0
-2950	-29.5
-2900	-29.0
-2850	-28.5
:	:
:	:
-100	-1.0
-50	-0.5
0	0.0
50	0.5
100	1.0
:	:
:	:
1350	13.5
1400	14.0
1450	14.5
1500	15.0

6.2.4. Dynamics

Ratio

Value	Display	Value	Display	Value	Display	Value	Display	Value	Display	Value	Display
10	1.0:1	42	4.2:1	74	7.4:1	106	10.6:1	138	13.8:1	170	17.0:1
11	1.1:1	43	4.3:1	75	7.5:1	107	10.7:1	139	13.9:1	171	17.1:1
12	1.2:1	44	4.4:1	76	7.6:1	108	10.8:1	140	14.0:1	172	17.2:1
13	1.3:1	45	4.5:1	77	7.7:1	109	10.9:1	141	14.1:1	173	17.3:1
14	1.4:1	46	4.6:1	78	7.8:1	110	11.0:1	142	14.2:1	174	17.4:1
15	1.5:1	47	4.7:1	79	7.9:1	111	11.1:1	143	14.3:1	175	17.5:1
16	1.6:1	48	4.8:1	80	8.0:1	112	11.2:1	144	14.4:1	176	17.6:1
17	1.7:1	49	4.9:1	81	8.1:1	113	11.3:1	145	14.5:1	177	17.7:1
18	1.8:1	50	5.0:1	82	8.2:1	114	11.4:1	146	14.6:1	178	17.8:1
19	1.9:1	51	5.1:1	83	8.3:1	115	11.5:1	147	14.7:1	179	17.9:1
20	2.0:1	52	5.2:1	84	8.4:1	116	11.6:1	148	14.8:1	180	18.0:1
21	2.1:1	53	5.3:1	85	8.5:1	117	11.7:1	149	14.9:1	181	18.1:1
22	2.2:1	54	5.4:1	86	8.6:1	118	11.8:1	150	15.0:1	182	18.2:1
23	2.3:1	55	5.5:1	87	8.7:1	119	11.9:1	151	15.1:1	183	18.3:1
24	2.4:1	56	5.6:1	88	8.8:1	120	12.0:1	152	15.2:1	184	18.4:1
25	2.5:1	57	5.7:1	89	8.9:1	121	12.1:1	153	15.3:1	185	18.5:1
26	2.6:1	58	5.8:1	90	9.0:1	122	12.2:1	154	15.4:1	186	18.6:1
27	2.7:1	59	5.9:1	91	9.1:1	123	12.3:1	155	15.5:1	187	18.7:1
28	2.8:1	60	6.0:1	92	9.2:1	124	12.4:1	156	15.6:1	188	18.8:1
29	2.9:1	61	6.1:1	93	9.3:1	125	12.5:1	157	15.7:1	189	18.9:1
30	3.0:1	62	6.2:1	94	9.4:1	126	12.6:1	158	15.8:1	190	19.0:1
31	3.1:1	63	6.3:1	95	9.5:1	127	12.7:1	159	15.9:1	191	19.1:1
32	3.2:1	64	6.4:1	96	9.6:1	128	12.8:1	160	16.0:1	192	19.2:1
33	3.3:1	65	6.5:1	97	9.7:1	129	12.9:1	161	16.1:1	193	19.3:1
34	3.4:1	66	6.6:1	98	9.8:1	130	13.0:1	162	16.2:1	194	19.4:1
35	3.5:1	67	6.7:1	99	9.9:1	131	13.1:1	163	16.3:1	195	19.5:1
36	3.6:1	68	6.8:1	100	10.0:1	132	13.2:1	164	16.4:1	196	19.6:1
37	3.7:1	69	6.9:1	101	10.1:1	133	13.3:1	165	16.5:1	197	19.7:1
38	3.8:1	70	7.0:1	102	10.2:1	134	13.4:1	166	16.6:1	198	19.8:1
39	3.9:1	71	7.1:1	103	10.3:1	135	13.5:1	167	16.7:1	199	19.9:1
40	4.0:1	72	7.2:1	104	10.4:1	136	13.6:1	168	16.8:1	200	20.0:1
41	4.1:1	73	7.3:1	105	10.5:1	137	13.7:1	169	16.9:1	201	∞:1

Knee

Value	Display
0	HARD
1	1
2	2
3	3
4	4
5	5

Keyin (Mono)

Value	Display
0	KeyIn
1	Self

Keyin (Stereo)

Value	Display
0	KeyIn
1	MaxIn
2	L
3	R

Keyin (Multi)

Value	Display	Value	Display	Value	Display
0	KeyIn	30	29	60	59
1	MaxIn	31	30	61	60
2	1	32	31	62	61
3	2	33	32	63	62
4	3	34	33	64	63
5	4	35	34	65	64
6	5	36	35		
7	6	37	36		
8	7	38	37		
9	8	39	38		
10	9	40	39		
11	10	41	40		
12	11	42	41		
13	12	43	42		
14	13	44	43		
15	14	45	44		
16	15	46	45		
17	16	47	46		
18	17	48	47		
19	17	49	48		
20	19	50	49		
21	20	51	50		
22	21	52	51		
23	22	53	52		
24	23	54	53		
25	24	55	54		
26	25	56	55		
27	26	57	56		
28	27	58	57		
29	28	59	58		

6.2.5. REV-X

Type

Value	Display
0	HALL
1	ROOM
2	PLATE

Hall/RevTime

Value	Display	Value	Display
0	0.279	36	3.630
1	0.372	37	3.720
2	0.466	38	3.820
3	0.559	39	3.910
4	0.652	40	4.000
5	0.745	41	4.100
6	0.838	42	4.190
7	0.931	43	4.280
8	1.020	44	4.380
9	1.120	45	4.470
10	1.210	46	4.560
11	1.300	47	4.660
12	1.400	48	5.120
13	1.490	49	5.590
14	1.580	50	6.050
15	1.680	51	6.520
16	1.770	52	6.980
17	1.860	53	7.450
18	1.960	54	7.920
19	2.050	55	8.380
20	2.140	56	8.850
21	2.230	57	9.310
22	2.330	58	10.200
23	2.420	59	11.200
24	2.510	60	12.100
25	2.610	61	13.000
26	2.700	62	14.000
27	2.790	63	14.900
28	2.890	64	15.800
29	2.980	65	16.800
30	3.070	66	17.700
31	3.170	67	18.600
32	3.260	68	23.300
33	3.350	69	27.900
34	3.450		
35	3.540		

Room/RevTime

Value	Display	Value	Display
0	0.409	36	5.320
1	0.545	37	5.450
2	0.681	38	5.590
3	0.818	39	5.720
4	0.954	40	5.860
5	1.090	41	6.000
6	1.230	42	6.130
7	1.360	43	6.270
8	1.500	44	6.410
9	1.640	45	6.540
10	1.770	46	6.680
11	1.910	47	6.810
12	2.040	48	7.500
13	2.180	49	8.180
14	2.320	50	8.860
15	2.450	51	9.540
16	2.590	52	10.200
17	2.730	53	10.900
18	2.860	54	11.600
19	3.000	55	12.300
20	3.130	56	12.900
21	3.270	57	13.600
22	3.410	58	15.000
23	3.540	59	16.400
24	3.680	60	17.700
25	3.820	61	19.100
26	3.950	62	20.400
27	4.090	63	21.800
28	4.220	64	23.200
29	4.360	65	24.500
30	4.500	66	25.900
31	4.630	67	27.300
32	4.770	68	34.100
33	4.910	69	40.900
34	5.040		
35	5.180		

Plate/RevTime

Value	Display	Value	Display
0	0.469	36	6.100
1	0.626	37	6.260
2	0.782	38	6.410
3	0.938	39	6.570
4	1.090	40	6.730
5	1.250	41	6.880
6	1.410	42	7.040
7	1.560	43	7.190
8	1.720	44	7.350
9	1.880	45	7.510
10	2.030	46	7.660
11	2.190	47	7.820
12	2.350	48	8.600
13	2.500	49	9.380
14	2.660	50	10.200
15	2.820	51	10.900
16	2.970	52	11.700
17	3.130	53	12.500
18	3.280	54	13.300
19	3.440	55	14.100
20	3.600	56	14.900
21	3.750	57	15.600
22	3.910	58	17.200
23	4.070	59	18.800
24	4.220	60	20.300
25	4.380	61	21.900
26	4.540	62	23.500
27	4.690	63	25.000
28	4.850	64	26.600
29	5.000	65	28.200
30	5.160	66	29.700
31	5.320	67	31.300
32	5.470	68	39.100
33	5.630	69	46.900
34	5.790		
35	5.940		

HPF/LPF/LowFreq

Value	Display	Value	Display
0	Thru	36	1200
1	22	37	1400
2	25	38	1600
3	28	39	1800
4	32	40	2000
5	36	41	2200
6	40	42	2500
7	45	43	2800
8	50	44	3200
9	56	45	3600
10	63	46	4000
11	70	47	4500
12	80	48	5000
13	90	49	5600
14	100	50	6300
15	110	51	7000
16	125	52	8000
17	140	53	9000
18	160	54	10000
19	180	55	11000
20	200	56	12000
21	225	57	14000
22	250	58	16000
23	280	59	18000
24	315	60	Thru
25	355		
26	400		
27	450		
28	500		
29	560		
30	630		
31	700		
32	800		
33	900		
34	1000		
35	1100		

* HPF 0 - 52, LPF : 34 - 60, LowFreq : 1 - 59

6.2.6. EQ**6.2.6.1. PEQ****Type**

Value	Display
0	PEQ
1	L.SHELF 6dB/Oct
2	L.SHELF 12dB/Oct
3	H.SHELF 6dB/Oct
4	H.SHELF 12dB/Oct
5	HPF
6	LPF

6.2.7. Filter

6.2.7.1. HPF/LPF/BPF

HPF/LPF Type

Value	Display
0	Thru
1	6dB/Oct
2	12dB/Oct AdjustGc
3	12dB/Oct Butrwrth
4	12dB/Oct Bessel
5	12dB/Oct Linkwitz
6	18dB/Oct AdjustGc
7	18dB/Oct Butrwrth
8	18dB/Oct Bessel
9	24dB/Oct AdjustGc
10	24dB/Oct Butrwrth
11	24dB/Oct Bessel
12	24dB/Oct Linkwitz
13	36dB/Oct AdjustGc
14	36dB/Oct Butrwrth
15	36dB/Oct Bessel
16	48dB/Oct AdjustGc
17	48dB/Oct Butrwrth
18	48dB/Oct Bessel
19	48dB/Oct Linkwitz

6.2.8. Mixer

6.2.8.1. Dugan Automixer

Mode

Value	Display
0	Mute
1	Man
2	Auto

Group (2 - 4 Channel)

Value	Display
0	a
1	b

Group (5 - 8 Channel)

Value	Display
0	a
1	b
2	c
3	d

Group (9 - 64 Channel)

Value	Display
0	a
1	b
2	c
3	d
4	e
5	f
6	g
7	h

6.2.9. Oscillator

Waveform

Value	Display
0	SINE 100Hz
1	SINE 1kHz
2	SINE 10kHz
3	Pink
4	Burst
5	VARI

6.2.10. Standard SPP/C-Series SPP(FIR)

HPF/LPF Type

Value	Display
0	Thru
1	6dB/Oct
2	12dB ADJGC
3	12dB BUT
4	12dB BESSL
5	12dB L-R
6	18dB ADJGC
7	18dB BUT
8	18dB BESSL
9	24dB ADJGC
10	24dB BUT
11	24dB BESSL
12	24dB L-R
13	36dB ADJGC
14	36dB BUT
15	36dB BESSL
16	48dB ADJGC
17	48dB BUT
18	48dB BESSL
19	48dB L-R

EQ Type

Value	Display
0	PEQ
1	L.SHELF 6dB/Oct
2	L.SHELF 12dB/Oct
3	H.SHELF 6dB/Oct
4	H.SHELF 12dB/Oct
5	HPF
6	LPF
7	APF1
8	APF2
9	HORN

7. Parameter List

7.1. Audio Component

Parameter Name		MIN	MAX	unit	setr	Remarks		
DANTE OUT	Polarity	NORMAL	INVERTED	-		0:NORMAL 1:INVERTED		
	Gain	-96.0	24.0	dB		dB x 10 ex. -14.5dB x 10 = -145		
USB OUT	Polarity	NORMAL	INVERTED	-		0:NORMAL 1:INVERTED		
	Gain	-96.0	24.0	dB		dB x 10 ex. -14.5dB x 10 = -145		
SD Card	Level	-∞	0.00	dB		dB x 100 ex. -73.60dB x 100 = -7360 -∞ = -13801		
Acoustic Echo Canceller	Reference	InputGain	-∞	10.00	dB		dB x 100 ex. -73.60dB x 100 = -7360 -∞ = -13801	
		FE Delay	0	200	-			
		Auto	OFF	ON	-		0: OFF 1: ON	
		DelayOffset	-50	50	-			
	Mic	On	OFF	ON	-		0: OFF 1: ON	
		InputGain	-∞	10.00	dB		dB x 100 ex. -73.60dB x 100 = -7360 -∞ = -13801	
		Effect	0	3	-		0:Soft 1:Medium 2:Hard 3:Custom	
		LinearAEC	0	3	-			
		NR	0	4	-			
		Echo Supp	0	4	-			
Ambient Noise Compensator	Ambient	Threshold	-∞	0.00	dB		dB x 100 ex. -73.60dB x 100 = -7360 -∞ = -13801	
		Gap	Threshold	-∞	0.00	dB		dB x 100 ex. -73.60dB x 100 = -7360 -∞ = -13801
	Program	Time	0.1	5.0	s		sec x 10 ex. 3.8sec x 10 = 38	
		MaxGain	0.0	18.0	dB		dB x 100 ex. 5.2dB x 100 = 520	
		MinGain	-18.0	0.0	dB		dB x 100 ex. -14.5dB x 10 = -1450	
		Ratio*	0.5:1	2.0:1	-		* See "6. Parameter Value Details" -> See "6.2.1. Ambient Noise Compensator".	
		ResponseTime	1	60	s			
		On	OFF	ON	-		0: OFF 1: ON	
	Audio Detector	Detect	Threshold	-90	0	dB		
			Hold	0.1	10.0	s		sec x 10 ex. 3.8sec x 10 = 38
HoldInfinity			OFF	ON	-		0: OFF 1: ON	
Status		Active	OFF	ON	-		0: OFF 1: ON	
		On	OFF	ON	-		0: OFF 1: ON	
Auto Gain Control	Compensator	ResponseTime*	100m	5.0	s		* See "6. Parameter Value Details" -> "6.2.2. Auto Gain Control".	
		Level	1	5	-			
		NoiseGateOn	OFF	ON	-		0: OFF 1: ON	
	On	OFF	ON	-		0: OFF 1: ON		

Parameter Name		MIN	MAX	unit	setr	Remarks		
Combiner	Room Combiner	BGM	Source*	BGM1	BGM4	-	* See "6. Parameter Value Details"-> "6.2.3. Combiner".	
			On	OFF	ON	-	0: OFF 1: ON	
			Level	-∞	10.00	dB	✓	dB x 100 ex.-73.60dB x 100 = -7360 -∞ = -13801
		Paging	On	OFF	ON	-	0: OFF 1: ON	
			Level	-∞	10.00	dB	✓	dB x 100 ex.-73.60dB x 100 = -7360 -∞ = -13801
			Level	-∞	10.00	dB	✓	dB x 100 ex.-73.60dB x 100 = -7360 -∞ = -13801
		RoomIn	On	OFF	ON	-	0: OFF 1: ON	
			Level	-∞	10.00	dB	✓	dB x 100 ex.-73.60dB x 100 = -7360 -∞ = -13801
			Level	-∞	10.00	dB	✓	dB x 100 ex.-73.60dB x 100 = -7360 -∞ = -13801
		RoomOut	On	OFF	ON	-	0: OFF 1: ON	
			Level	-∞	10.00	dB	✓	dB x 100 ex.-73.60dB x 100 = -7360 -∞ = -13801
			Level	-∞	10.00	dB	✓	dB x 100 ex.-73.60dB x 100 = -7360 -∞ = -13801
	Combine	On	OFF	ON	-	0: OFF 1: ON		
		On	OFF	ON	-	0: OFF 1: ON		
		On	OFF	ON	-	0: OFF 1: ON		
	Room Combiner plus Automixer	Group	Override	OFF	ON	-	0: OFF 1: ON	
			Mute	OFF	ON	-	0: OFF 1: ON	
			Mute	OFF	ON	-	0: OFF 1: ON	
		MicsIn	On	OFF	ON	-	0: OFF 1: ON	
			Level	-∞	10.00	dB	✓	dB x 100 ex.-73.60dB x 100 = -7360 -∞ = -13801
			Level	-∞	10.00	dB	✓	dB x 100 ex.-73.60dB x 100 = -7360 -∞ = -13801
		BGM	Source*	BGM1	BGM4	-	* See "6. Parameter Value Details"-> "6.2.3. Combiner".	
			On	OFF	ON	-	0: OFF 1: ON	
			Level	-∞	10.00	dB	✓	dB x 100 ex.-73.60dB x 100 = -7360 -∞ = -13801
Paging		On	OFF	ON	-	0: OFF 1: ON		
		Level	-∞	10.00	dB	✓	dB x 100 ex.-73.60dB x 100 = -7360 -∞ = -13801	
		Level	-∞	10.00	dB	✓	dB x 100 ex.-73.60dB x 100 = -7360 -∞ = -13801	
RoomIn	On	OFF	ON	-	0: OFF 1: ON			
	Level	-∞	10.00	dB	✓	dB x 100 ex.-73.60dB x 100 = -7360 -∞ = -13801		
	Level	-∞	10.00	dB	✓	dB x 100 ex.-73.60dB x 100 = -7360 -∞ = -13801		
RoomOut	On	OFF	ON	-	0: OFF 1: ON			
	Level	-∞	10.00	dB	✓	dB x 100 ex.-73.60dB x 100 = -7360 -∞ = -13801		
	Level	-∞	10.00	dB	✓	dB x 100 ex.-73.60dB x 100 = -7360 -∞ = -13801		
Combine	On	OFF	ON	-	0: OFF 1: ON			
	On	OFF	ON	-	0: OFF 1: ON			
	On	OFF	ON	-	0: OFF 1: ON			
MicCh	Mode*	Mute	Auto	-	* See "6. Parameter Value Details"-> "6.2.3. Combiner".			
	Weight	-100.0	15.0	-	* See "6. Parameter Value Details"-> "6.2.3. Combiner".			
	Override	OFF	ON	-	0: OFF 1: ON			
Group	Override	OFF	ON	-	0: OFF 1: ON			
	Mute	OFF	ON	-	0: OFF 1: ON			
	Mute	OFF	ON	-	0: OFF 1: ON			
DCA	Patch	On	OFF	ON	-	0: OFF 1: ON		
		On	OFF	ON	-	0: OFF 1: ON		
	Group	Offset	-∞	10.00	dB	✓	dB x 100 ex.-73.60dB x 100 = -7360 -∞ = -13801	
		Min	-∞	10.00	dB	✓	dB x 100 ex.-73.60dB x 100 = -7360 -∞ = -13801	
		Max	-∞	10.00	dB	✓	dB x 100 ex.-73.60dB x 100 = -7360 -∞ = -13801	

7. Parameter List

Parameter Name		MIN	MAX	unit	setr	Remarks	
Delay	On	OFF	ON	-		0: OFF 1: ON	
	DelayTime	0.00	1000.00	ms		ms x 100 ex. 102.80ms x 100 = 10280	
Dynamics	Compressor	Threshold	-60	0	dB		dB x 100 ex. -60dB x 100 = -6000
		Ratio*	1.0:1	∞:1	-		* See "6. Parameter Value Details" -> "6.2.4. Dynamics".
		Knee*	HARD	5	-		* See "6. Parameter Value Details" -> "6.2.4. Dynamics".
		Attack	0	120	ms		
		Release	3.34m	42.7	s		sec x 1000000 ex. 3.34m = 0.00334s 0.00334s x 1000000 = 3340
		Gain	-20.0	40.0	dB		dB x 100 ex. -20.0dB x 100 = -2000
		KeyIn*	KEYIN	64	-		* See "6. Parameter Value Details" -> "6.2.4. Dynamics".
		On	OFF	ON	-		0: OFF 1: ON
	Comp260	Threshold	-60	0	dB		dB x 100 ex. -60dB x 100 = -6000
		Ratio	1.0:1	∞:1	-		x100 ex 1.0:1 1.0 x 100 = 100 ∞:1 if the value exceeds 50000
		Knee*	HARD	5	-		* See "6. Parameter Value Details" -> "6.2.4. Dynamics".
		Attack	0.01m	80.0m	ms		ms x 1000 ex. 0.01m x 1000 = 10
		Release*	6.2m	999.0m	ms		ms x 10 ex. 6.2m x 10 = 62
		Gain	-20.0	40.0	dB		dB x 100 ex. -20.0dB x 100 = -2000
		KeyIn*	KEYIN	SELF	-		* See "6. Parameter Value Details" -> "6.2.4. Dynamics".
		On	OFF	ON	-		0: OFF 1: ON
	De-Esser	Threshold	-60.0	0.0	dB		dB x 10 ex. -60.0dB x 10 = -600
		Frequency	800	16.0k	Hz		Hz x 10 ex. 800Hz x 10 = 8000
		Q	0.5	25.0	-		x 10 ex. 0.5 x 10 = 5
		Type	BELL	H.SHELF			0: BELL 1: H.SHELF
		On	OFF	ON	-		0: OFF 1: ON
	Ducker	Threshold	-72	0	dB		dB x 100 ex. -72dB x 100 = -7200
		Range	-∞	0	dB		dB x 100 ex. -60dB x 100 = -6000 -∞ for less than -7200.
		Attack	0m	240m	-		
		Release	3.34m	42.7	s		sec x 1000000 ex. 3.34m = 0.00334s 0.00334 x 1000000 = 3340
		Hold	0.02m	1.96	s		sec x 1000000 ex. 0.02m = 0.00002s 0.00002s x 1000000 = 20
		KeyIn*	KEYIN	SELF	-		* See "6. Parameter Value Details" -> "6.2.4. Dynamics".
		On	OFF	ON	-		0: OFF 1: ON
Gate	Threshold	-72	0	dB		dB x 100 ex. -72dB x 100 = -7200	
	Range	-∞	0	-		dB x 100 ex. -60dB x 100 = -6000 -∞ for less than -7200.	
	Attack	0m	120m	-			
	Decay	3.34m	42.7	s		sec x 1000000 ex. 3.34m = 0.00334s 0.00334s x 1000000 = 3340	
	Hold*	0.02m	1.96	s		sec x 1000000 ex. 0.02m = 0.00002s 0.00002s x 1000000 = 20	
	KeyIn*	KEYIN	SELF	-		* See "6. Parameter Value Details" -> "6.2.4 Dynamics".	
	On	OFF	ON	-		0: OFF 1: ON	

Parameter Name		MIN	MAX	unit	setr	Remarks		
Dynamics	Limiter	Threshold	-72	0	dB		dB x 100 ex. -72dB x 100 = -7200	
		Attack	0.0	120m	ms		ms x 10 ex. 24.5ms x 10 = 245	
		Release	3.34m	42.7	s		sec x 1000000 ex. 3.34m = 0.00334s 0.00334s x 1000000 = 3340	
		KeyIn*	KEYIN	SELF	-		* See "6. Parameter Value Details" -> "6.2.4. Dynamics".	
		On	OFF	ON	-		0: OFF 1: ON	
	Paging Ducker		Range	-∞	0.0	dB		dB x 100 ex. -30dB x 100 = -3000 -∞ for less than -6000
			Attack	0.0	10.0	s		s x 10 ex. 5.3s x 10 = 53
			Release	0.0	10.0	s		s x 10 ex. 5.3s x 10 = 53
			Hold	0.0	10.0	s		s x 10 ex. 5.3s x 10 = 53
			Trigger	OFF	ON	-		0: OFF 1: ON
		On	OFF	ON	-		0: OFF 1: ON	
	Status	Active	OFF	ON	-		0: OFF 1: ON	
	Program Ducker		Detect Threshold	-60.0	0.0	dB		dB x 100 ex. -60dB x 100 = -6000
			Hold Time	1.0	10.0	s		s x 10 ex. 1.0s x 10 = 10
			Mode	0	1	-		
			Attack	0.0	10.0	s		s x 10 ex. 10s x 10 = 100
			Range	-∞	0.0	dB		dB x 100 ex. -30dB x 100 = -3000 -∞ for less than -6000.
			Release	0.0	10.0	s		s x 10 ex. 10s x 10 = 100
			Bypass	OFF	ON	-		0: OFF 1: ON
	REV-X		Type	Hall	Plate	-		* See "6. Parameter Value Details" -> "6.2.5. REV-X".
RevTime*			0.103s	10.3s			* See "6. Parameter Value Details" -> "6.2.5. REV-X".	
InitialDelay			1.0m	125m	ms		ms x 10 ex. 1.0m x 10 = 10	
Decay			0	53	-			
RoomSize			0	28	-			
Difussion			0	10	-			
HPF*			Thru	8.0k	-		* See "6. Parameter Value Details" -> "6.2.5. REV-X".	
LPF*			Thru	1.0k	-		* See "6. Parameter Value Details" -> "6.2.5. REV-X".	
HiRatio			0.1	1.0			x 10 ex. 0.1 x 10 = 10	
LowRatio			0.1	1.4			x 10 ex. 0.1 x 10 = 10	
LowFreq*			22.0	18.0k	-		* See "6. Parameter Value Details" -> "6.2.5. REV-X".	
MixBal			0.0	100.0	-			
On			OFF	ON	-		0: OFF 1: ON	

Parameter Name			MIN	MAX	unit	setr	Remarks	
EQ	GEQ	Limit	±15	-24	dB		0: +-15 1: +-12 2: +-6 3: -24	
		HPF	Frequency	20.0	20.0k	Hz		Hz x 10 ex. 20Hz x 10 = 200
			Bypass	OFF	ON	-		0: OFF 1: ON
		LPF	Frequency	20.0	20.0k	Hz		Hz x 10 ex. 20Hz x 10 = 200
			Bypass	OFF	ON	-		0: OFF 1: ON
		Notch	Frequency	20.0	20.0k	Hz		Hz x 10 ex. 20Hz x 10 = 200
			Bypass	OFF	ON	-		0: OFF 1: ON
			Q	63.0	0.1	-		x 1000 ex. 63.0 x 1000 = 63000
		GEQ	Gain	-24.0	15.0	dB		* The Min. and max values depend on the limit. dB x 100 ex. -24dB x 100 = -2400
			Bypass	OFF	ON	-		0: OFF 1: ON
	On		OFF	ON	-		0: OFF 1: ON	
	PEQ	Q	63.0	0.1	-		x 1000 ex. 63.0 x 1000 = 63000	
		Frequency	20.0	20.0k	Hz		Hz x 1000 ex. 1000Hz x 1000 = 1000000	
		Gain*	-18.0	18.0	dB		dB x 100 ex. -18dB x 100 = -1800 * Not adjustable for HPF/LPF	
Bypass		OFF	ON	-		0: OFF 1: ON		
Type		PEQ	LPF	-		* See "6. Parameter Value Details" -> "6.2.6. EQ"		
On		OFF	ON	-		0: OFF 1: ON		
Fader	Level		-∞	10.00	dB	✓	dB x 100 ex. -73.60dB x 100 = -7360 -∞ = -13801	
	On		OFF	ON	-		0: OFF 1: ON	
	Polarity		OFF	ON	-		0: OFF 1: ON	
Feedback Suppressor	Notch FBS	Dynamic	AutoDetect	OFF	ON	-	0: OFF 1: ON	
		FixedOn	On	OFF	ON	-	0: OFF 1: ON	
	Pitch Shift FBS	Mode	Speech	Music	-			
		Suppression	0	9	-			
On		OFF	ON	-		0: OFF 1: ON		
Filter	LPF	Frequency	20.0	20.0k	Hz		Hz x 10 ex. 1000Hz x 10 = 10000	
		FilterType(*)	Thru	48dB/Oct Linkwitz	-		* See "6. Parameter Value Details" -> "6.2.7. Filter"	
		Gc*	-6	6	dB		*Available only when filter type is AdjustGc	
		On	OFF	ON	-		0: OFF 1: ON	
	HPF	Frequency	20.0	20.0k	Hz		Hz x 10 ex. 1000Hz x 10 = 10000	
		FilterType*	Thru	48dB/Oct Linkwitz	-		* See "6. Parameter Value Details" -> "6.2.7. Filter"	
		Gc*	-6	6	dB		*Available only when filter type is AdjustGc	
		On	OFF	ON	-		0: OFF 1: ON	

7. Parameter List

Parameter Name			MIN	MAX	unit	setr	Remarks		
Filter	BPF	LPF	Frequency	20.0	20.0k	Hz		Hz x 10 ex. 1000Hz x 10 = 10000	
			FilterType*	Thru	48dB/Oct Linkwitz	-		* See "6. Parameter Value Details" -> "6.2.7. Filter".	
			Gc*	-6	6	dB		*Available only when filter type is AdjustGc	
			Bypass	OFF	ON	-		0: OFF 1: ON	
		HPF	Frequency	20.0	20.0k	Hz		Hz x 10 ex. 1000Hz x 10 = 10000	
			FilterType*	Thru	48dB/Oct Linkwitz	-		* See "6. Parameter Value Details" -> "6.2.7. Filter".	
			Gc*	-6	6	dB		*Available only when filter type is AdjustGc	
			Bypass	OFF	ON	-		0: OFF 1: ON	
				On	OFF	ON	-		0: OFF 1: ON
		Meter			AttackTime	0m	2200m	ms	
			ReleaseTime	0m	2200m	ms			
Mixer	Dugan Automixer	Group	Override	OFF	ON	-		0: OFF 1: ON	
			Mute	OFF	ON	-		0: OFF 1: ON	
		Ch	Mode*	Mute	Auto	-		* See "6. Parameter Value Details" -> "6.2.8. Mixer".	
			Weight	-100.0	15.0	dB		dB x 100 ex. -100.0dB x 100 = -10000	
			Group*	a	b (2 - 4 Channel) d (5 - 8 Channel) h (9 - 64 Channel)	-		* See "6. Parameter Value Details" -> "6.2.8. Mixer".	
			Override	OFF	ON	-		0: OFF 1: ON	
	Delay Matrix	Ch	Level	-∞	10.00	dB	✓	dB x 100 ex. -73.60dB x 100 = -7360 -∞ = -13801	
			On	OFF	ON	-		0: OFF 1: ON	
			DelayTime	0.00	1000.00	ms		ms x 1000 ex. 102.80ms x 1000 = 102800	
	Matrix Mixer	Ch	Level	-∞	10.00	dB	✓	dB x 100 ex. -73.60dB x 100 = -7360 -∞ = -13801	
			On	OFF	ON	-		0: OFF 1: ON	
	Oscillator			Level	-96	0.0	dB	dB x 100 ex. -73.60dB x 100 = -7360	
			VariFrequency	20.0	20.0k	Hz	Hz x 10 ex. 1000Hz x 10 = 10000		
			Waveform*	SINE 100Hz	VARI	-	* See "6. Parameter Value Details" -> "6.2.9. Oscillator".		
			HPF	Frequency	20.0	20.0k	Hz	Hz x 10 ex. 1000Hz x 10 = 10000	
				On	OFF	ON	-	0: OFF 1: ON	
			LPF	Frequency	20.0	20.0k	Hz	Hz x 10 ex. 1000Hz x 10 = 10000	
				On	OFF	ON	-	0: OFF 1: ON	
			Width	100	10000				
			Interval	1	30				
			On	OFF	ON	-	0: OFF 1: ON		
Ping Pong Delay			On	OFF	ON		0: OFF 1: ON		
			Delay	10	13500	ms			
			Feedback Gain	-99	99	%			
			MixBal	0	100		x 10 ex. 0.1 x 10 = 1		
			High Ratio	0.1	1				
			HPF	20.0	8.00k	Hz	Hz x 10 ex. 1000Hz x 10 = 10000		
			LPF	50.0	16.0k / Thru	Hz	Hz x 10 ex. 1000Hz x 10 = 10000		
							ex. Thru = 160010		
Polarity			Polarity	NORMAL	INVERTED	-	0:NORMAL 1:INVERTED		
Router			Patch	NONE	256	-			

7. Parameter List

Parameter Name		MIN	MAX	unit	setr	Remarks	
Source Selector	Source*	1	4(4 position) 8(8 position) 16(16 position)	-			
	Level	-∞	10.00	dB	✓	dB x 100 ex. -73.60dB x 100 = -7360 -∞ = -13801	
Standard SPP	Input	Level	-∞	10.00	dB	✓	dB x 100 ex. -73.60dB x 100 = -7360 -∞ = -13801
		Delay	On	OFF	ON	-	0: OFF 1: ON
	XOver	Time	0.00	200	ms		ms x 1000 ex. 102.80ms x 100 = 102800
		LPF/Frequency	20.0	20.0k	Hz		Hz x 10 ex. 100Hz x 10 = 1000
		HPF/Frequency	20.0	20.0k	Hz		Hz x 10 ex. 100Hz x 10 = 1000
		LPF/Type	Thru	48dB L-R	-		* See "6. Parameter Value Details" -> "6.2.10. Standard SPP/C-Series SPP(FIR)".
		HPF/Type	Thru	48dB L-R	-		* See "6. Parameter Value Details" -> "6.2.10. Standard SPP/C-Series SPP(FIR)".
		LPF/Gc*	-6	6	dB		*Available only when filter type is AdjustGc
		HPF/Gc*	-6	6	dB		*Available only when filter type is AdjustGc
	Center	Polarity	NORMAL	INVERTED	-		0:NORMAL 1:INVERTED
		Frequency	20.0	20.0k	Hz		Hz x 10 ex. 100Hz x 10 = 1000
	EQ	Q*	0.1	63	-		* Available when PEQ/APF 2nd chosen x 1000 ex. 63.0 x1000 = 63000
		Frequency	20	20.0k	Hz		Hz x 10 ex. 100Hz x 10 = 1000
		Gain*	-18.0	18.0	dB		* Not available when HPF/LPF/APF 1st/APF 2nd chosen dB x 100 ex. -14.5dB x 100 = -1450
		Bypass	OFF	ON	-		0: OFF 1: ON
		Type	PEQ	HORN	-		* See "6. Parameter Value Details" -> "6.2.10. Standard SPP/C-Series SPP(FIR)".
		On	OFF	ON	-		0: OFF 1: ON
PeakLimiter	Threshold	10	5000	W			
	Attack	0.0	120.0	ms		ms x 10 ex. 24.5ms x 10 = 245	
	Release	0	60000	ms			
	On	OFF	ON	-		0: OFF 1: ON	
Standard SPP	RMSLimiter	Threshold	10	5000	W		
		Attack	0.0	30.0	s		s x 10 ex. 24.5s x 10 = 245
		Release	0	60	s		s x 10 ex. 24.5s x 10 = 245
		On	OFF	ON	-		0: OFF 1: ON
	Output	Level	-∞	10.00	dB	✓	dB x 100 ex. -73.60dB x 100 = -7360 -∞ = -13801
Mute		UNMUTED	MUTED	-		0:UNMUTED 1:MUTED	
C-Series SPP(FIR)	Input	Level	-∞	10.00	dB	✓	dB x 100 ex. -73.60dB x 100 = -7360 -∞ = -13801
		Delay	On	OFF	ON	-	0: OFF 1: ON
	Time	0.00	200	ms		ms x 1000 ex. 102.80ms x 100 = 102800	

Parameter Name			MIN	MAX	unit	setr	Remarks
C-Series SPP(FIR)	XOver	LPF/Frequency	20.0	20.0k	Hz		Hz x 10 ex. 100Hz x 10 = 1000
		HPF/Frequency	20.0	20.0k	Hz		Hz x 10 ex. 100Hz x 10 = 1000
		LPF/Type	Thru	48dB L-R	-		* See "6. Parameter Value Details" -> "6.2.10. Standard SPP/C-Series SPP(FIR)".
		HPF/Type	Thru	48dB L-R	-		* See "6. Parameter Value Details" -> "6.2.10. Standard SPP/C-Series SPP(FIR)".
		LPF/Gc*	-6	6	dB		*Available only when filter type is AdjustGc
		HPF/Gc*	-6	6	dB		*Available only when filter type is AdjustGc
		Polarity	NORMAL	INVERTED	-		0:NORMAL 1:INVERTED
	Center	Frequency	20.0	20.0k	Hz		Hz x 10 ex. 100Hz x 10 = 1000
	EQ	Q*	0.1	63	-		*Available when PEQ/APF 2nd chosen x 1000 ex. 63.0 x1000 = 63000
		Frequency	20	20.0k	Hz		Hz x 10 ex. 100Hz x 10 = 1000
		Gain*	-18.0	18.0	dB		*Not available when HPF/LPF/APF 1st/APF 2nd chosen dB x 100 ex. -14.5dB x 100 = -1450
		Bypass	OFF	ON	-		0: OFF 1: ON
		Type	PEQ	HORN	-		* See "6. Parameter Value Details" -> "6.2.10. Standard SPP/C-Series SPP(FIR)".
		On	OFF	ON	-		0: OFF 1: ON
	PeakLimiter	Threshold	10	5000	W		
		Attack	0.0	120.0	ms		ms x 10 ex. 24.5ms x 10 = 245
		Release	0	60000	ms		
		On	OFF	ON	-		0: OFF 1: ON
	RMSLimiter	Threshold	10	5000	W		
		Attack	0.0	30.0	s		s x 10 ex. 24.5s x 10 = 245
		Release	0	60	s		s x 10 ex. 24.5s x 10 = 245
		On	OFF	ON	-		0: OFF 1: ON
	Output	Level	-∞	10.00	dB	✓	dB x 100 ex. -73.60dB x 100 = -7360 -∞ = -13801
		Mute	UNMUTED	MUTED	-		0:UNMUTED 1:MUTED

7.2. Control Component

Parameter Name			MIN	MAX	unit	setr	Remarks
Input (Normalized Value)	Button	On	OFF	ON	-		0: OFF 1: ON
	Radio Button	On	NONE	256			
	Fader	Value	0.00	1.00			x 100 ex.1.00 x 100 = 100
Input (Value)	Button	On	OFF	ON	-		0: OFF 1: ON
	Radio Button	On	NONE	256			
	Fader	dB	-∞	10.00	dB	✓	dB x 100 ex. -73.60dB x 100 = -7360 -∞ = -13801
		Num	-20000	20000			
Processing (Value)	Multi Compare	Threshold	-90	0	dB		
Processing	Delay	On	OFF	ON	-		0: OFF 1: ON
	Suspend	On	OFF	ON	-		0: OFF 1: ON
	Router	Patch	NONE	256	-		0: OFF 1: ON

8. Meter List

Component		Meter Name	Type	Remarks	
Dante IN		INPUT 1-16	Level	level	
		INPUT 17-32	Level	level	
		INPUT 49-64	Level	level	
		INPUT 65-80	Level	level	
		INPUT 81-96	Level	level	
		INPUT 97-112	Level	level	
		INPUT 113-128	Level	level	
		INPUT 129-144	Level	level	
		INPUT 145-160	Level	level	
		INPUT 161-176	Level	level	
		INPUT 177-192	Level	level	
		INPUT 193-208	Level	level	
		INPUT 209-224	Level	level	
		INPUT 225-240	Level	level	
	INPUT 241-256	Level	level		
Dante OUT		OUTPUT 1-16	Level	level	
		OUTPUT 17-32	Level	level	
		OUTPUT 49-64	Level	level	
		OUTPUT 65-80	Level	level	
		OUTPUT 81-96	Level	level	
		OUTPUT 97-112	Level	level	
		OUTPUT 113-128	Level	level	
		OUTPUT 129-144	Level	level	
		OUTPUT 145-160	Level	level	
		OUTPUT 161-176	Level	level	
		OUTPUT 177-192	Level	level	
		OUTPUT 193-208	Level	level	
		OUTPUT 209-224	Level	level	
		OUTPUT 225-240	Level	level	
	OUTPUT 241-256	Level	level		
USB IN		INPUT1-8	Level	level	
USB OUT		OUTPUT1-8	Level	level	
Acoustic Echo Cancellor		Reference	RefIn	level	
		INPUT 1-n	MicIn	level	
		ERL 1-n	ERL	gr+100	
		ERLE 1-n	ERLE	gr+100	
	OUTPUT 1-n	Out	level		
Ambient Noise Compensator		Mono/Stereo/Multi AMBIENT SOURCE	Ambient	level	
		Mono OUTPUT Stereo OUTPUT L, OUTPUT R Multi* OUTPUT 1-n	Out	level	* The meter can be received even though it is not shown in the Editor.
Audio Detector		Status	Status	raw	
Auto Gain Control		Mono INPUT Stereo INPUT L, INPUT R Multi* INPUT 1-n	In	level	* The meter can be received even though it is not shown in the Editor.
		Mono OUTPUT Stereo OUTPUT L, OUTPUT R Multi* OUTPUT 1-n	Out	level	* The meter can be received even though it is not shown in the Editor.
Combiner	Room Combiner plus Automixer	Mic 1 - 64 Channel level	Level	level	Input level which applied Weight parameter
		Mic 1 - 64 Channel input gain	In	level	
		Mic 1 - 64 Channel auto mix gain	Gain	level	
		Mic 1 - 64 Channel output gain	Out	level	

Component			Meter Name	Type	Remarks
Dynamics	Compressor / Comp260 / De-Esser / Ducker / Gate / Limiter	Mono OUTPUT	Level	level	* The meter can be received even though it is not shown in the Editor.
		Stereo OUTPUT L, OUTPUT R Multi* OUTPUT 1-n			
		Mono/Stereo/Multi GR	GR	gr	
	Program Ducker	Mono OUTPUT	Level	level	* The meter can be received even though it is not shown in the Editor.
		Stereo OUTPUT L, OUTPUT R Multi* OUTPUT 1-n			
		Key In Level	KeyIn	level	
Paging Ducker	Mono OUTPUT	Level	level		
	Stereo OUTPUT L, OUTPUT R Multi OUTPUT 1-n				
	Status	Status	raw		
EQ	GEQ	Mono INPUT	In	level	* The meter can be received even though it is not shown in the Editor.
		Stereo INPUT L, INPUT R Multi* INPUT 1-n			
		Mono OUTPUT	Out	level	* The meter can be received even though it is not shown in the Editor.
		Stereo OUTPUT L, OUTPUT R Multi* OUTPUT 1-n			
Fader		Mono Level 1 to Level n	Level	level	
		Stereo Level 1L, Level 1R to Level nL, Level nR			
		Multi Level 1-n			
Meter		Level 1-n	Level	level	
Matrix	Delay Matrix	OUTPUT 1-n	Level	level	
	Dugan Automixer	Mic 1 - 64 Channel level	Level	level	
		Mic 1 - 64 Channel input gain	In	level	
		Mic 1 - 64 Channel auto mix gain	Gain	level	
		Mic 1 - 64 Channel output gain	Out	level	
	Matrix Mixer	OUTPUT 1-n	Level	level	
Oscillator		OUTPUT	Level	level	
Probe		OUTPUT	Oscillator	level	
		Monitor 1-2	Monitor	level	
Source Selector		Source 1- 6	Level	level	

Component	Meter Name	Type	Remarks
Speaker Processor	In	level	
1/2/3/4 Way INPUT			
1 Way PEAK LIMITER OUT RMS LIMITER OUT	Limiter Out	level	
2 Way PEAK LIMITER OUT(LF) PEAK LIMITER OUT(HF) RMS LIMITER OUT(LF) RMS LIMITER OUT(HF)			
3 Way PEAK LIMITER OUT(LF) PEAK LIMITER OUT(MF) PEAK LIMITER OUT(HF) RMS LIMITER OUT(LF) RMS LIMITER OUT(MF) RMS LIMITER OUT(HF)			
4 Way PEAK LIMITER OUT(LF) PEAK LIMITER OUT(LMF) PEAK LIMITER OUT(HMF) PEAK LIMITER OUT(HF) RMS LIMITER OUT(LF) RMS LIMITER OUT(LMF) RMS LIMITER OUT(HMF) RMS LIMITER OUT(HF)			
1 Way PEAK LIMITER GR RMS LIMITER GR	Limiter GR	gr	
2 Way PEAK LIMITER GR(LF) PEAK LIMITER GR(HF) RMS LIMITER GR(LF) RMS LIMITER GR(HF)			
3 Way PEAK LIMITERGR(LF) PEAK LIMITER GR(MF) PEAK LIMITER GR(HF) RMS LIMITER GR(LF) RMS LIMITER GR(MF) RMS LIMITER GR(HF)			
4 Way PEAK LIMITER GR(LF) PEAK LIMITER GR(LMF) PEAK LIMITER GR(HMF) PEAK LIMITER GR(HF) RMS LIMITER GR(LF) RMS LIMITER GR(LMF) RMS LIMITER GR(HMF) RMS LIMITER GR(HF)			
Speaker Processor	Out	Out	
1 Way OUTPUT			
2 Way OUTPUT(LF) OUTPUT(HF)			
3 Way OUTPUT(LF) OUTPUTR(MF) OUTPUT(HF)			
4 Way OUTPUTR(LF) OUTPUT(LMF) OUTPUT(HMF) OUTPUT(HF)			