

# YAMAHA

DVD/VIDEO CD/CD PLAYER

# DVD-S700

Before attempting to connect, operate or adjust this product, please read this Operating Instructions manual completely. Please save this manual.



## Operating Instructions

# Safety information

**Note:**

**For Continental Europe, United Kingdom and Australia models**

This unit can be used only where the power supply is AC 220–240 V, 50 Hz. It cannot be used elsewhere.

**For other models**

This unit can be used only where the power supply is AC 110–240 V, 50/60 Hz. It cannot be used elsewhere.

**CAUTION:**

**DVD/VIDEO CD/CD PLAYER IS A CLASS 1 LASER PRODUCT. HOWEVER THIS DVD/VIDEO CD/CD PLAYER USES A VISIBLE LASER BEAM WHICH COULD CAUSE HAZARDOUS RADIATION EXPOSURE IF DIRECTED. BE SURE TO OPERATE THE DVD/VIDEO CD/CD PLAYER CORRECTLY AS INSTRUCTED.**

**WHEN THIS DVD/VIDEO CD/CD PLAYER IS PLUGGED TO THE WALL OUTLET, DO NOT PLACE YOUR EYES CLOSE TO THE OPENING OF THE DISC TRAY AND OTHER OPENINGS TO LOOK INTO THE INSIDE OF THIS PLAYER.**

**USE OF CONTROLS OR ADJUSTMENTS OR PERFORMANCE OF PROCEDURES OTHER THAN THOSE SPECIFIED HEREIN MAY RESULT IN HAZARDOUS RADIATION EXPOSURE.**

**DO NOT OPEN COVERS AND DO NOT REPAIR YOURSELF. REFER SERVICING TO QUALIFIED PERSONNEL.**

**WARNING:**

**TO REDUCE THE RISK OF FIRE OR ELECTRIC SHOCK, DO NOT EXPOSE THIS EQUIPMENT TO RAIN OR MOISTURE.**

**TO REDUCE THE RISK OF FIRE OR ELECTRIC SHOCK, AND ANNOYING INTERFERENCE, USE THE RECOMMENDED ACCESSORIES ONLY.**

**THIS DEVICE IS INTENDED FOR CONTINUOUS OPERATION!**

This unit is not disconnected from the AC power source as long as it is connected to the wall outlet, even if this unit itself is turned off. This state is called the standby mode.

In this state, this unit is designed to consume a very small quantity of power.

CAUTION	-LASER RADIATION WHEN OPEN. DO NOT STARE INTO BEAM.
ATTENTION	-RAYONNEMENT LASER EN CAS D'OUVERTURE. NE PAS REGARDER DANS LE FAISCEAU.
VORSICHT	-LASERSTRAHLUNG, WENN ABDECKUNG GEÖFFNET. NICHT IN DEN STRAHL BLICKEN.
ADVARSEL	-LASERSTRÅLING VED ÅBNING. SE IKKE IND I STRÅLEN.
ADVARSEL	-LASERSTRÅLING NÅR DEKSEL ÅPNES. STIRR IKKE INN I STRÅLEN.
VARNING	-LASERSTRÅLNING NÅR DENNA DEL ÄR ÖPPNAD. STIRRA EJ IN I STRÅLEN.
VARO!	-AVATTAESSA OLET ALTTIINA LASERSÄTEILYLLE. ÄLÄ TUJOTA SÄTEESEEN.
注意	- 当打开这里会出现激光, 请不要直视激光。
注意	- ここを開くとレーザー光が出ます。 レーザー光をのぞき込まないでください。

(Inside of product)

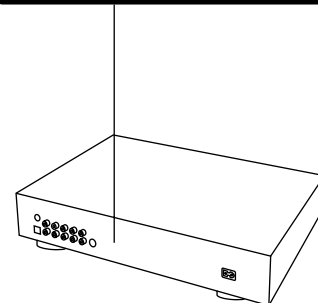

(Back of product)



## Caution for AC mains lead (For United Kingdom)

### For your safety please read the following text carefully

This appliance is supplied with a moulded three pin mains plug for your safety and convenience.

A 5 amp fuse is fitted in this plug.

Should the fuse need to be replaced please ensure that the replacement fuse has a rating of 5 amps and that it is approved by ASTA or BSI to BS 1362.

Check for the ASTA mark  or the BSI mark  on the body of the fuse.

If the plug contains a removable fuse cover you must ensure that it is refitted when the fuse is replaced.

If you lose the fuse cover the plug must not be used until a replacement cover is obtained.

A replacement fuse cover can be purchased from your local dealer.

IF THE FITTED MOULDED PLUG IS UNSUITABLE FOR THE SOCKET OUTLET IN YOUR HOME THEN THE FUSE SHOULD BE REMOVED AND THE PLUG CUT OFF AND DISPOSED OF SAFELY.

THERE IS A DANGER OF SEVERE ELECTRICAL SHOCK IF THE CUT OFF PLUG IS INSERTED INTO ANY 13 AMP SOCKET.

If a new plug is to be fitted please observe the wiring code as shown below.

If in any doubt please consult a qualified electrician.

If the socket outlets in the home are not suitable for the plug supplied with this appliance, it should be cut off and an appropriate 3 pin plug fitted. For details, refer to the instructions described below.

**Note:** The plug severed from the mains lead must be destroyed, as a plug with bared flexible cord is hazardous if engaged in a live socket outlet.

### IMPORTANT

The wires in this mains lead are coloured in accordance with the following code:

Blue: Neutral

Brown: Live

As the colours of the wires in the mains lead of this appliance may not correspond with the coloured markings identifying the terminals in your plug, proceed as follows:

The wire which is coloured BLUE must be connected to the terminal in the plug which is marked with the letter N or coloured BLACK.

The wire which is coloured BROWN must be connected to the terminal in the plug which is marked with the letter L or coloured RED.

Under no circumstances should either of these wires be connected to the earth terminal of the three pin plug, marked with the letter E or Earth Symbol .

### How to replace the Fuse

• There are two types of the supplied AC Mains Lead: (A) and (B) as shown below.

1 Open the fuse compartment with a screwdriver.

2 Replace the fuse and fuse cover.

TYPE (A)

1

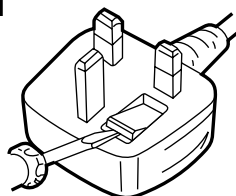

2

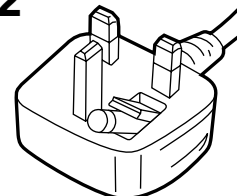

TYPE (B)

1

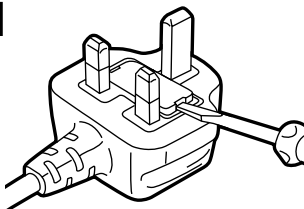

2

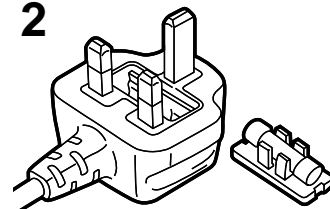

## Dear Customers

May we take this opportunity to thank you for purchasing this YAMAHA DVD/VIDEO CD/CD player. We strongly recommend that you carefully study the Operating Instructions before attempting to operate the unit and that you note the listed precautions.

## Features

### ■ DVD: a completely new dimension in video entertainment

- Subtitles may be displayed in one of a maximum of 32 languages\*.
- The audio soundtrack can be heard in up to 8 languages\*.
- The multi-angle function allows you to choose the viewing angle of scenes which were shot from a number of different angles. (Limited to DVD recorded with multiple camera angles.)

\*The number of the languages recorded is dependent on the software.

### ■ High quality digital audio

- The Dolby Digital (AC-3)/MPEG 1/2 2–5.1ch audio/Linear PCM decoder is built into the player which makes it possible to enjoy Multi-Channel Surround sound.
- With the linear PCM sound of a 48 kHz/16 bit through 96 kHz/24 bit, audio quality exceeding that of CDs becomes possible.

### ■ Many convenient features

- GUI (Graphical User Interface) screens for showing the disc information or player information and providing access to many major functions of this unit
- Programming of up to 5 scenes in memory (markers)
- Parental lock settings to prevent play of discs unsuitable for some audiences [DVD only]

### ■ Compatible with PAL DVD (Video CD) and NTSC DVD (Video CD)

- This player can play discs recorded in either PAL or NTSC format.

#### For Continental Europe, United Kingdom and Australia models

However, the player must be connected to a PAL TV which is capable of receiving PAL 525/60 system to play both PAL DVD (Video CD) and NTSC DVD (Video CD).

#### For other areas models

However, the player must be connected to a Multi-system TV to play both PAL DVD (Video CD) and NTSC DVD (Video CD). The use of a Multi-system TV is recommended.

### ■ Compatible with Video CD and CD as well as DVD

### ■ Disc formats supported by this player

The unit can play back discs bearing any of the following marks:



**DVD**  
[8 cm disc/  
12 cm disc]



**Video CD**  
[8 cm disc/  
12 cm disc]



**CD**  
[8 cm disc/  
12 cm disc]

## Accessories

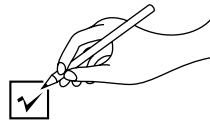

Please check and identify the supplied accessories.

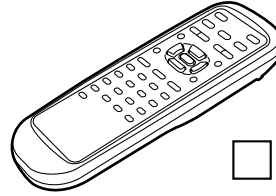

Remote control unit ..... 1

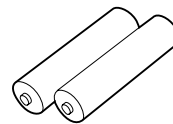

Batteries ..... 2  
for remote control unit  
[size "AA" (R6P)]

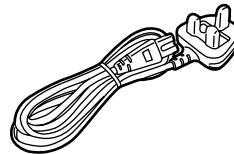

AC mains lead ..... 1  
(For United Kingdom model)

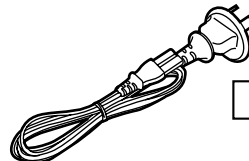

AC mains lead ..... 1  
(For Australia model)

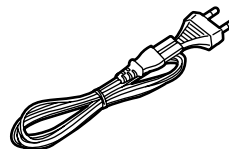

AC mains lead ..... 1  
(For Continental Europe  
models and other models)

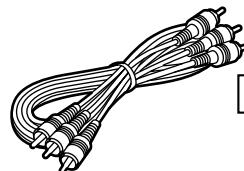

Video/audio cord ..... 1

# Table of contents

## Getting Started:

Safety information .....	2
Caution for AC mains lead (For United Kingdom) .....	3
Features .....	4
Accessories .....	4
Precautions .....	6
Selecting the type of disc for the type of the connected TV (For other areas) .....	6
Control reference guide .....	7
Front panel display .....	9
Connection .....	10
Remote control preparation .....	13
Before enjoying DVD/Video CD/CD .....	14

## Basic Operation:

Basic play .....	14
•Basic play .....	14
•Stopping play .....	16
•Skipping ahead or back .....	16
Rapid advance (Rapid reverse) .....	17
Still picture (Pause) .....	17
Frame advance [DVD/Video CD] .....	17
Slow-motion play [DVD/Video CD] .....	18
Enjoying Video CDs with playback control without using menus [Video CD only] .....	18

## Operation Using GUI Screens:

General information about GUI screens .....	19
•Common procedures .....	19
Detailed descriptions of each GUI icon .....	20
•Screen for disc information .....	20
•Screen for player information .....	21
•Screen for slow-motion play and rapid advance (reverse) .....	21

## Advanced Operation:

Program play [Video CD/CD] .....	22
Random play [Video CD/CD] .....	23
Repeat play .....	24
•Repeat viewing (listening) .....	24
•Repeating sections between two specific points (A-B repeat) .....	25
Storing markers in memory to be viewed (listened) again .....	26
•Storing a marker in the memory .....	26
•Recalling/clearing a marker .....	26
Changing subtitle language [DVD only] .....	27
Changing audio soundtrack language [DVD only] .....	28
Switching vocals ON or OFF for Karaoke discs [DVD/Video CD] .....	28
Viewing from another angle [DVD only] .....	29
Using a title menu [DVD only] .....	30
Using a DVD menu [DVD only] .....	30

## Initial Settings:

Initial settings .....	31
•Common procedures of initial settings .....	31
•Selecting disc languages [DVD only] .....	32
•Selecting rating level [DVD only] .....	33
•Selecting language of On-Screen Display menu .....	34
•Switching the On-Screen Display ON or OFF .....	35
•Selecting the display brightness .....	35
•Selecting TV screen type .....	36
•Selecting digital output .....	37
•Speaker setting .....	39
•Other settings .....	41

## For Your Reference:

Disc handling and maintenance .....	42
Language code list .....	43
Troubleshooting .....	44
Self-diagnosis display function .....	45
Definition of terms .....	46
Specifications .....	47
Region Management Information .....	Back cover

## Precautions

Please read these precautions before operating this unit.

### ■ Mains lead protection

To avoid any malfunctions of the unit, and to protect against electric shock, fire or personal injury, please observe the following.

- **Hold the plug firmly when connecting or disconnecting the AC mains lead to this unit.**
- **Do not connect or disconnect the AC mains lead when your hands are wet.**
- **Keep the AC mains lead away from heating appliances.**
- **Never put any heavy object on the AC mains lead.**
- **Do not attempt to repair or reconstruct the AC mains lead in any way.**
- **Remove dust, dirt, etc. on the plug at regular intervals.**
- **If the unit has been dropped or otherwise damaged, set the unit to the standby mode and disconnect the AC mains lead.**
- **If smoke, malodors or noises are emitted from the unit, set the unit to the standby mode and disconnect the AC mains lead.**

### ■ Placement

Avoid placing the unit in areas of:

- direct sunlight or heating radiators, or closed automobiles
  - high temperature (over 35°C) or high humidity (over 90%)
  - excessive dust
  - vibration, impact or where the surface is tilted
- As the internal parts may be seriously damaged.

### ■ Non-use periods

When the unit is not being used, switch the unit to the standby mode.

When left unused for a long period of time, the unit should be unplugged from the household AC outlet.

### ■ No fingers or other objects inside

- Touching internal parts of this unit is dangerous, and may cause serious damage to the unit. Do not attempt to disassemble the unit.
- Do not put any foreign object on the disc tray.

### ■ Keep away from water and magnets.

- Keep the unit away from flower vases, tubs, sinks, etc. If liquids are spilled into the unit, serious damage could occur.
- Never bring magnetic objects such as speakers near to this unit.

### ■ Stacking

- Place the unit in a horizontal position, and do not place anything heavy on it.
- Do not place the unit on amplifiers or other equipment which may become hot.

### ■ Condensation

Moisture may form on the lens in the following conditions...

- immediately after a heater has been turned on.
- in a steamy or very humid room.
- when the unit is moved from a cold environment to a warm one.

If moisture forms inside this unit, it may not operate properly. In this case, turn on the power and wait about one hour for the moisture to evaporate.





### ■ If there is noise interference on the TV while a broadcast is being received

Depending on the reception condition of the TV, interference may appear on the TV screen while you are watching a TV broadcast and the unit is left on. This is not a malfunction of the unit or the TV. To watch a TV broadcast, switch this unit to the standby mode.

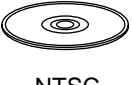

## Selecting the type of disc for the type of connected TV (For other models)

Both DVDs and Video CDs have the material recorded in the PAL and NTSC systems. Refer to the table below to select the correct disc type for the type of connected TV.

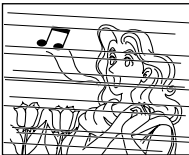

### ■ Connecting to the Multi-system TV

Disc	TV Monitor
 <p>PAL</p>	 <p>Played in the PAL system.</p>
 <p>NTSC</p>	 <p>Played in the NTSC system.</p>

### ■ Connecting to the NTSC TV

Disc	TV Monitor
 <p>PAL</p>	 <p>No clear images are shown on the screen.</p>
 <p>NTSC</p>	 <p>Played in the NTSC system.</p>

### ■ Connecting to the PAL TV

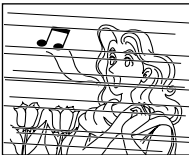
Disc	TV Monitor
 <p>PAL</p>	 <p>Played in the PAL system. However, the initial settings and Video CD's "Program Play" functions cannot be used.</p>
 <p>NTSC</p>	 <p>No clear images are shown on the screen.</p>

### Note:

When a disc which does not comply with Video CD standard is played, the bottom part of the picture may disappear.

# Control reference guide

## Main unit

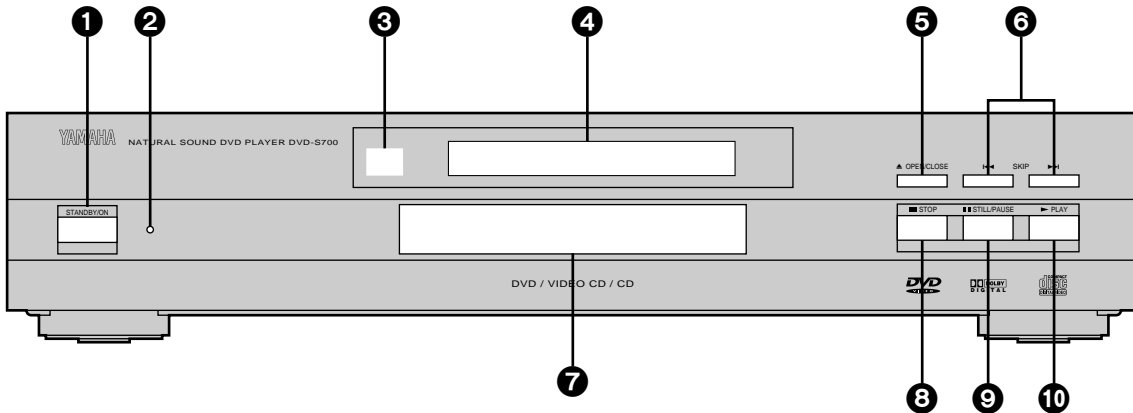

Page

Page

- 1 STANDBY/ON button** ..... 14  
 Press to switch the unit to ON from Standby mode or vice versa. In standby mode, the unit is still consuming a small amount of power.

### Standby mode

In this state, this unit consumes a very small quantity of power to receive infrared-signals from the remote control transmitter.

- 2 STANDBY indicator**  
 When the unit is connected to the AC mains supply, this indicator lights up in standby mode and goes out when the unit is turned on.

- 3 Remote control signal sensor** ..... 13  
**4 Display window** ..... 9  
**5 OPEN/CLOSE button** ..... 14  
**6 SKIP buttons** ..... 15, 16  
**7 Disc tray** ..... 14  
**8 STOP button** ..... 16  
**9 STILL/PAUSE button** ..... 17  
**10 PLAY button** ..... 14

Remote control unit

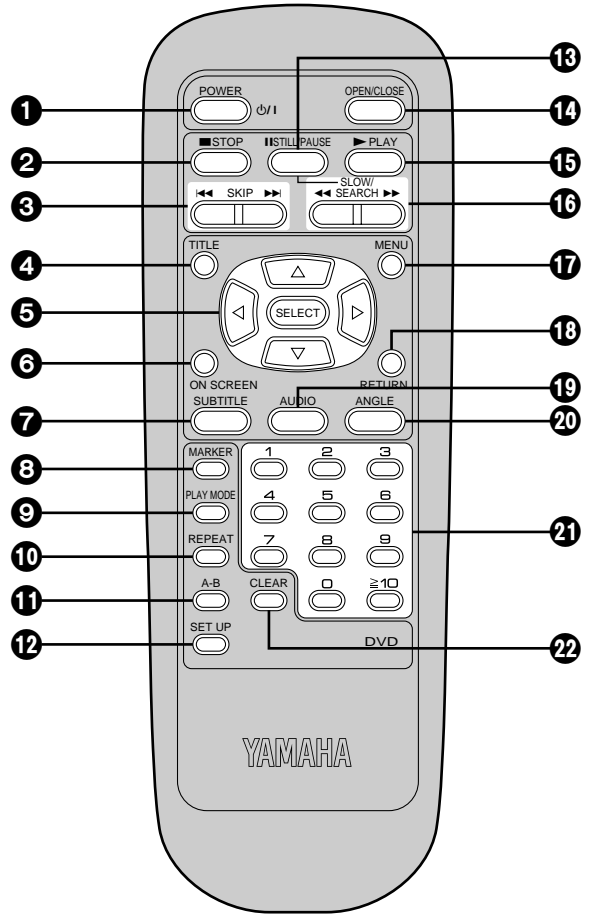

Page

① POWER $\phi$ /I button . . . . .	14
② STOP button . . . . .	16
③ SKIP buttons . . . . .	15, 16
④ TITLE button . . . . .	15, 30
⑤ Cursor buttons/SELECT button . . . . .	15
⑥ ON SCREEN button . . . . .	19
⑦ SUBTITLE button . . . . .	27
⑧ MARKER button . . . . .	26
⑨ PLAY MODE button . . . . .	22, 23
⑩ REPEAT button . . . . .	24
⑪ A-B button . . . . .	25
⑫ SET UP button . . . . .	31
⑬ STILL/PAUSE button . . . . .	17
⑭ OPEN/CLOSE button . . . . .	14
⑮ PLAY button . . . . .	14
⑯ SLOW/SEARCH buttons . . . . .	17, 18
⑰ MENU button . . . . .	15, 18, 30
⑱ RETURN button . . . . .	15, 19
⑲ AUDIO button . . . . .	28
⑳ ANGLE button . . . . .	29
㉑ Numeric buttons . . . . .	15
•To select a 2-digit number	
Example: To select track 23	
Press " $\cong$ 10", "2" and then "3".	
㉒ CLEAR button . . . . .	19, 23, 26, 32





# Front panel display

- ①  Rotates during play.  
Rotates fast clockwise or counterclockwise during rapid advance (reverse). (See page 17.)  
Rotates slowly clockwise or counterclockwise during slow-motion play.  
[DVD/Video CD] (See page 18.)
-  Illuminates in the stop mode.
- ② Illuminates during playback.  
Flashes when the RESUME function is ON.  
(See page 16.)
- ③ Illuminates during repeat play. (See pages 24 and 25.)
- ④ Illuminates in the pause mode. [CD] (See page 17.)
- ⑤ Indicates the chapter number. [DVD]  
Indicates the track number. [Video CD/CD]
- ⑥ Indicates the total playing time when the disc tray is closed. [Video CD/CD]  
Indicates the elapsed playing time from the start of the title/track during play.
- ⑦ Indicates the current audio channel information recorded in the disc (e.g. 2ch or 5.1ch).
- ⑧ Illuminates when a DVD is loaded.
- ⑨ Illuminates in the still picture mode.  
[DVD/Video CD] (See page 17.)
- ⑩ Illuminates during program play. [Video CD/CD]  
(See pages 22 and 23.)
- ⑪ Illuminates when it is possible to switch the angle [DVD] (See page 29.)
- ⑫ Illuminates when Linear PCM of 96 kHz sampling is being played.
- ⑬ Illuminates when Linear PCM of 24 bit is being played.
- ⑭ Illuminates when the disc tray is open.
- ⑮ Illuminates when the disc tray is being closed (retracted).
- ⑯ Illuminates during play of a DVD.
- ⑰ Illuminates during play of an interactive DVD.\*
- ⑱ Illuminates during play of a Karaoke DVD.
- ⑲ Illuminates during play of an interactive Karaoke DVD.\*
- ⑳ Illuminates during play of a Video CD.
- ㉑ Illuminates during play of a Video CD with playback control.
- ㉒ Illuminates during play of a CD.
- ㉓ Illuminates when playback is impossible.
  - DVDs for which playback is prohibited by the setup "Ratings". (See page 33.)**For Continental Europe and United Kingdom models**
  - DVDs with Region No. other than "2" or "ALL".**For Australia model**
  - DVDs with Region No. other than "4" or "ALL".**For other models**
  - DVDs with Region No. other than "3" or "ALL".  
(See page 42.)
- ㉔ Illuminates when no disc is loaded.

\*An interactive DVD is a DVD software which includes multiple angles, stories and so on.

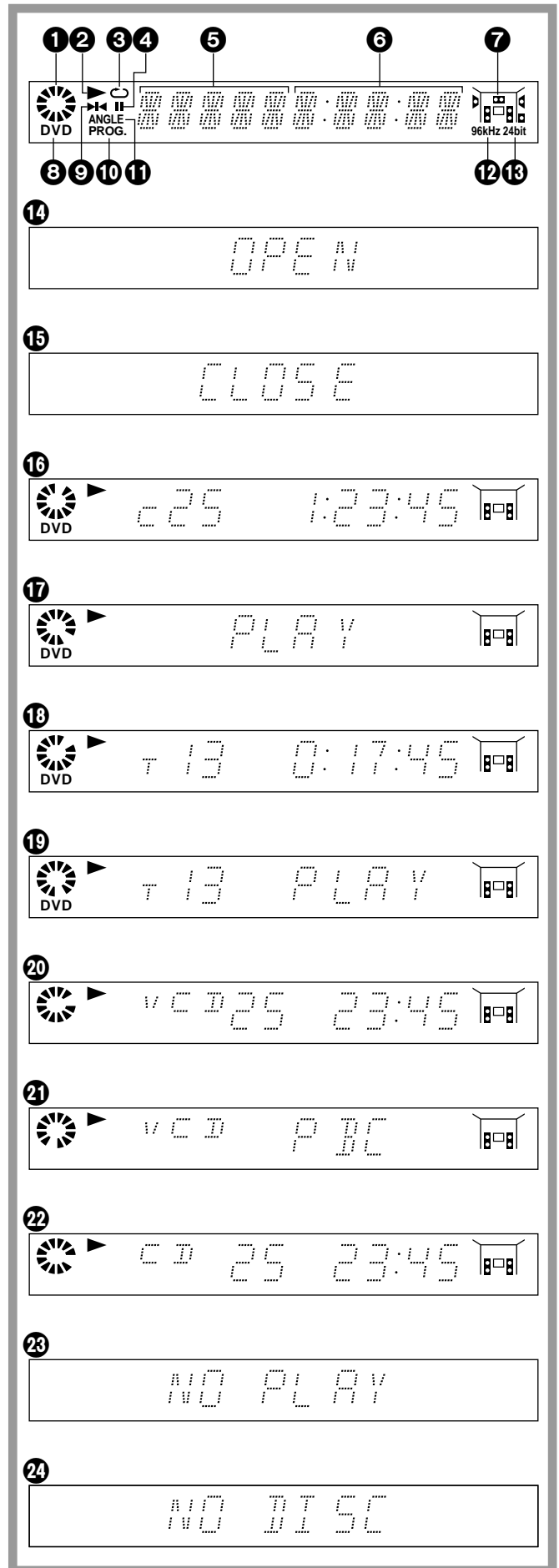

# Connection

**Never plug in this unit and other components until all connections are completed.**

- Be sure that the colors of the connectors and plugs match up when connecting the cord.
- Read through the instructions for the equipment to be connected.

## Connecting to an AV amplifier containing Dolby Digital (AC-3)/MPEG 1/2 2–5.1ch audio decoder

When DVDs recorded in Dolby Digital or MPEG audio are played, Dolby Digital bitstream or MPEG audio bitstream is output from the player's OPTICAL digital audio output connector or COAXIAL digital audio output connector. When the player is connected to a Dolby Digital decoder or MPEG audio decoder, you can enjoy theater-quality audio in your home. [An optical digital cable or coaxial audio cable (both optional) is required when an optional Dolby Digital decoder or MPEG audio decoder is used.]

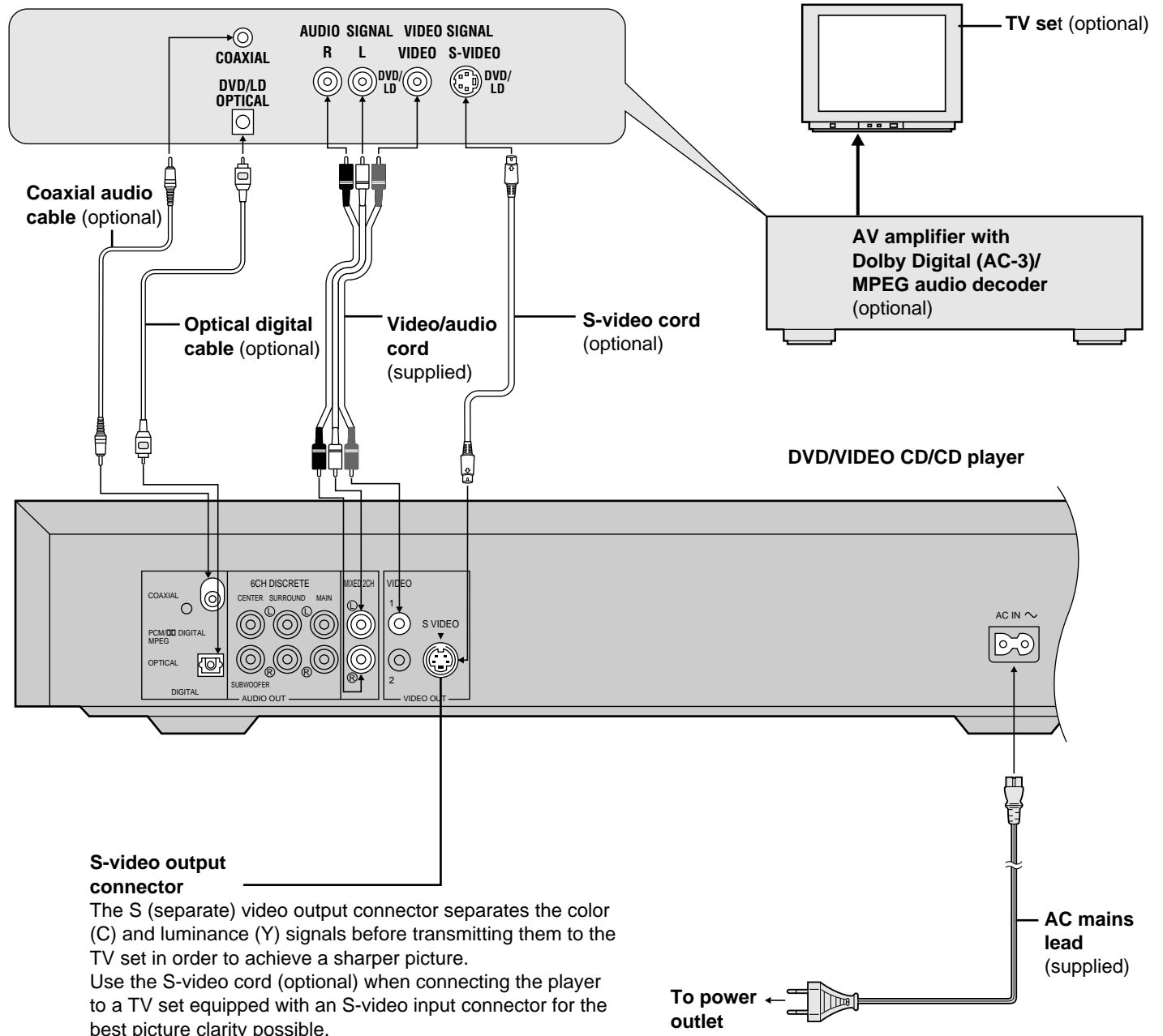

**Notes:**

- During DVD play, the TV volume may be at a lower level than during TV broadcasts, etc. If this is the case, adjust the volume to the desired level.

- If the DVD player is connected to the TV through a video cassette recorder, the picture may not be played back normally with some DVDs. If this is the case, do not connect the player via the VCR.

## Connection

### Notes when connecting the optical digital cable

- Remove the dust protection cap from the connector and connect the cable firmly so that configurations of both the cable and the connector match.
- Keep the dust protection cap and always reattach the cap when not using the connector to protect against dust.

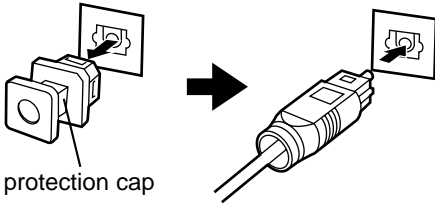

Dust protection cap

### Concerning the audio output from the unit's optical/coaxial digital audio output connector

Disc	Sound recording format	Optical/coaxial digital audio output from connector
DVD	Dolby Digital (AC-3)	Dolby Digital bitstream (2–5.1ch) or PCM (2ch) (48 kHz/16 bit)* <sup>1</sup>
	Linear PCM (48/96 kHz 16/20/24 bit)	Linear PCM (2ch) (48 kHz sampling/16 bit only)* <sup>2</sup> or no output* <sup>1</sup>
	MPEG	MPEG audio bitstream or PCM (2ch) (16 bit)* <sup>1</sup>
Video CD	MPEG 1	PCM (44.1 kHz sampling)
CD	Linear PCM	Linear PCM (44.1 kHz sampling)

\*<sup>1</sup>The type of audio output from the connector can be selected by the initial settings. (See page 37.)

\*<sup>2</sup>Sound having 96 kHz sampling converted into 48 kHz sampling when it is output from the unit's optical/coaxial digital audio output connector.

### For your reference:

- Dolby Digital (AC-3) is a digital sound compression technique developed by the Dolby Laboratories Licensing Corporation. Supporting 5.1-channel surround sound, as well as stereo (2-channel) sound, this technique enables a large quantity of sound data to be efficiently recorded on a disc.
- Linear PCM is a signal recording format used in CDs. While audio CDs are recorded in 44.1 kHz/16 bit, DVDs are recorded in 48 kHz/16 bit up to 96 kHz/24 bit.
- If you have a Dolby Pro Logic Surround decoder, you will obtain the full benefit of Pro Logic from the same DVD movies that provide full 5.1-channel Dolby Digital soundtracks, as well as from titles with the Dolby Surround mark.

### Caution for the optical/coaxial digital audio output connector:

- Do not connect an amplifier (with an optical/coaxial digital input connector) which does not contain the Dolby Digital (AC-3) or MPEG audio decoder.
- Otherwise any attempt to play DVDs may cause to such a high level of noise that it may be harmful to your ears and damage your speakers.
- Video CDs and CDs can be played as they would normally be played.

Manufactured under license from Dolby Laboratories. "Dolby" and the double-D symbol are trademarks of Dolby Laboratories. Confidential Unpublished Works. © 1992–1997 Dolby Laboratories, Inc. All rights reserved.

## Connection

### Connecting to an AV amplifier which does not contain Dolby Digital (AC-3)/MPEG audio decoder

This DVD/VIDEO CD/CD player contains a Dolby Digital (AC-3)/MPEG audio decoder. This enables the playback of DVDs recorded in Dolby Digital Surround, MPEG audio or Linear PCM without the need for an optional decoder with Dolby Digital, MPEG audio or Linear PCM processing. When the DVD player is connected to an AV amplifier with 5.1ch input connectors, you can enjoy theater-quality audio right in your home when playing discs recorded in Dolby Digital Surround, MPEG audio or Linear PCM.

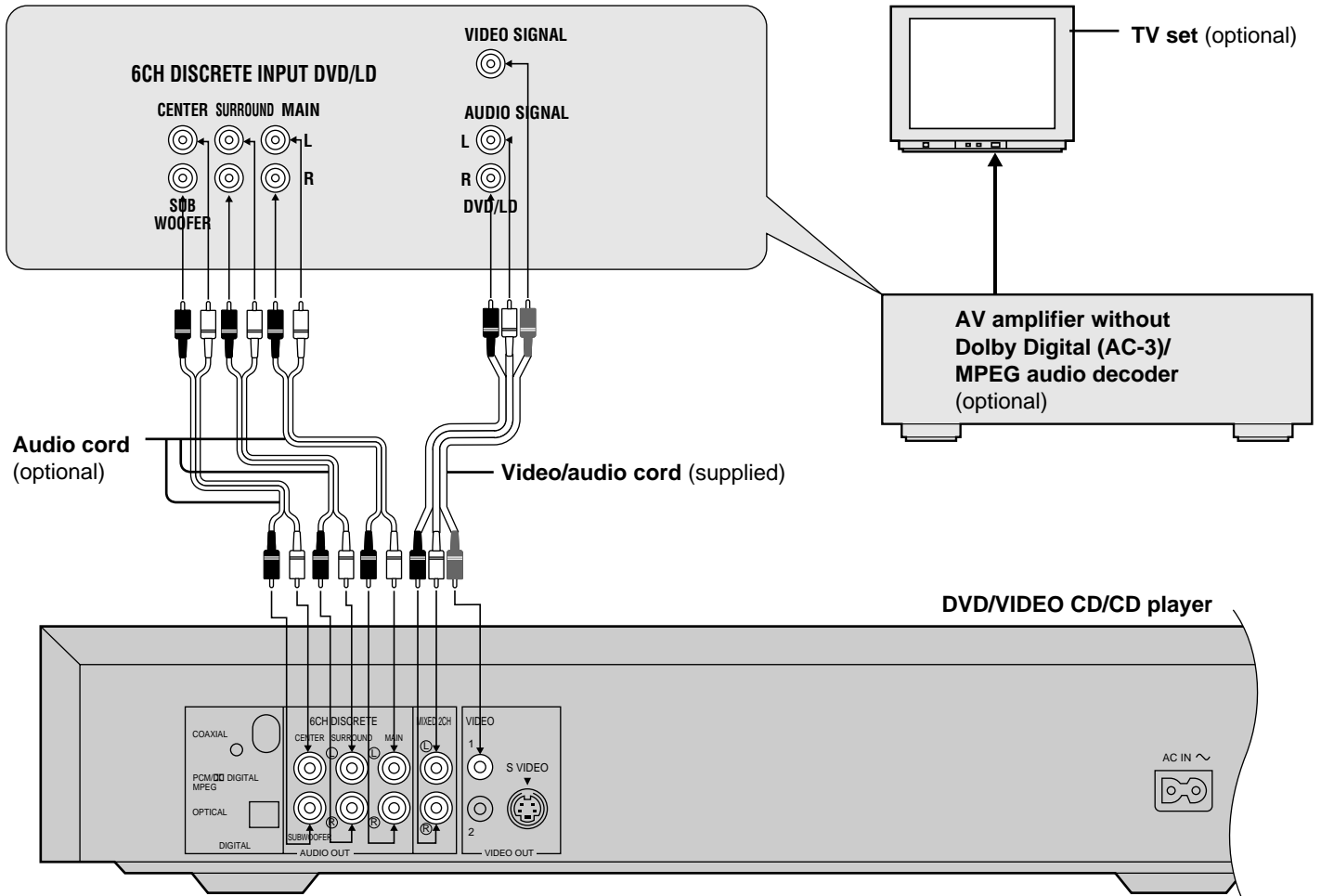

#### Notes:

- After connection is made, set the "Speaker setting" (such as Yes/No and Large/Small) according to your speaker system. (See page 39.)
- If the surround speakers or the center speaker can't be installed at an equal distance to (or further away from) the front speakers from the listening position, then change the delay time setting at the "Speaker setting" on page 39, to compensate.

- If the surround speakers are set to "None" at the "Speaker setting" (see page 39), the discs recorded in MPEG 2 audio or Linear PCM will be played back only in 2 channels even when the center speaker is connected as well as the front speakers.
- DVDs recorded in Linear PCM/96 kHz sampling in which "Center Speaker" is contained will also be played back only in 2ch.

## Remote control preparation

### Battery installation **A**

Insert the batteries while observing the correct (+) and (-) polarities as illustrated at right.

### Service life of batteries

- The batteries normally last for about one year although this depends on how often and for what operations the remote control is used.
- If the remote control unit fails to work even when it is operated near the player, replace the batteries.
- Use size "AA" (R6P) batteries.

#### Notes:

- Do not use rechargeable (Ni-Cd) batteries.
- Do not attempt to recharge, short-circuit, disassemble, heat or throw the batteries into the fire.
- Do not drop, step on or otherwise impact the remote control unit. This may damage the parts or lead to malfunction.
- Do not mix old and new batteries.
- If the remote control unit is not going to be used for a long time, remove the batteries. Otherwise, electrolyte may leak which may lead not only to malfunctioning but also to burns if contact is made with the electrolyte.
- Wipe away any electrolyte leaking inside the remote control unit, and install new batteries.
- If any electrolyte should come into contact with parts of your body, wash it off thoroughly with water.

### Remote control operation range **B**

Point the remote control unit no more than about 7 m from the remote control sensor and within about 60° of the front of the unit.

- The operating distance may vary according to the brightness of the room.

#### Notes:

- Do not point bright lights at the remote control sensor.
- Do not place objects between the remote control unit and the remote control sensor.
- Do not use this remote control unit while simultaneously operating the remote control unit of any other equipment.

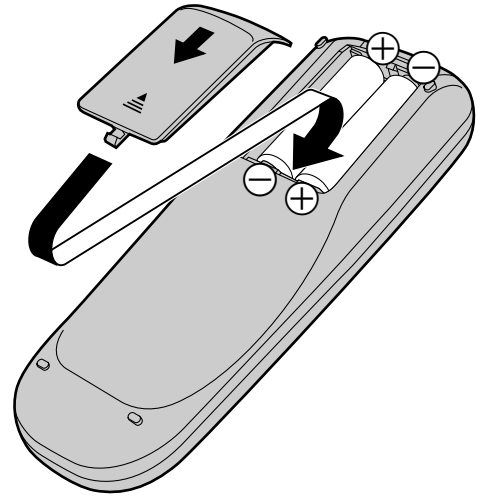
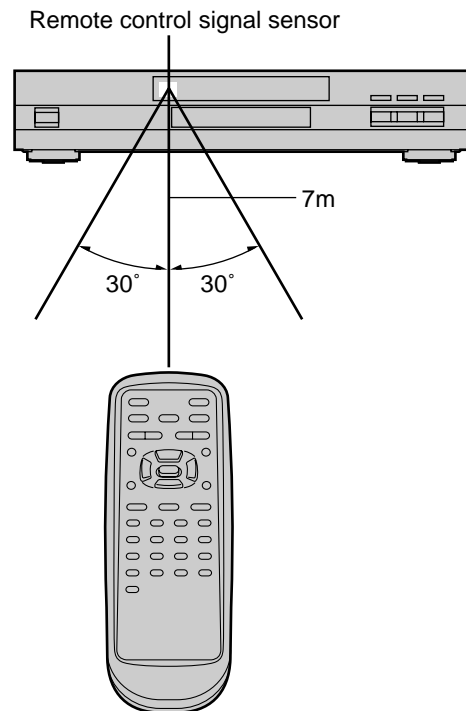
**A****B**

## Before enjoying DVD/Video CD/CD

The On-Screen menu language of your player has been factory pre-set to English.

If you would like to change the menu language to French, Spanish, German or Italian (for Continental Europe, United Kingdom and Australia models) or to French or Spanish (for other models), please refer to "Selecting language of On-Screen Display menu" on page 34.

In the explanations given below it is assumed that English has been selected as the menu language.

## Basic play

### Preparations

- Switch the TV ON and select the Audio/Video (AV) position, e.g. AV1, AV2, which has been connected to the player.
- Switch on the stereo system's power if the player has been connected to a stereo system.

### Basic play

**1** Press POWER to switch on the power.

**2** Press OPEN/CLOSE to open the disc tray.

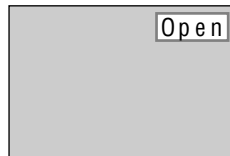

**3** Place a disc onto the disc tray.

Hold the disc without touching either of its surfaces, position it with the printed title side facing up, align it with the guides, and place it in its proper position.

- ① 8 cm disc
- ② 12 cm disc

**4** Press PLAY.

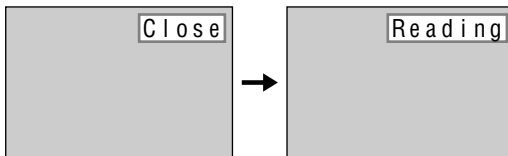

The disc tray is automatically closed and play begins.

- When the disc tray is closed by pressing OPEN/CLOSE, press PLAY to commence play.

• When a menu screen appears on the TV monitor

In case of interactive DVDs or Video CDs with playback control, a menu screen appears on the TV monitor. Perform step 5 on page 15 to commence play.

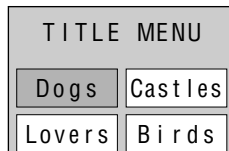

(Example of DVD)

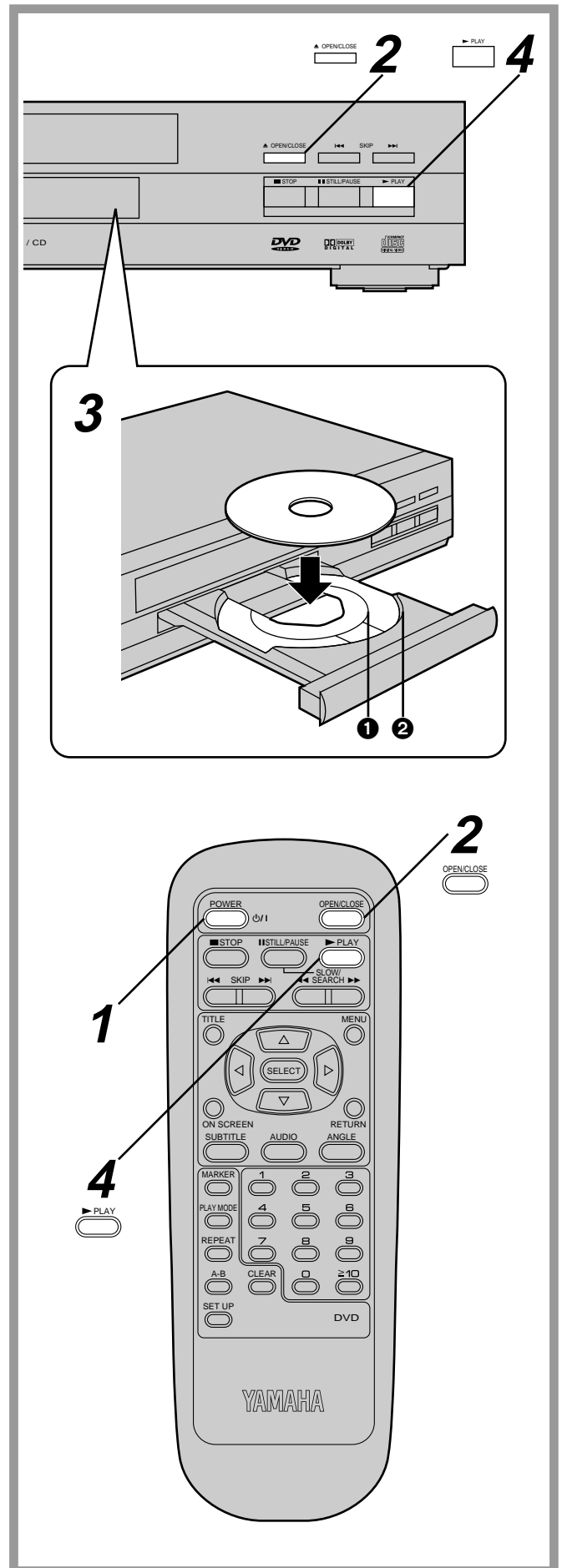

## Basic play

**5** Press ◀▶/▲/▼ and press SELECT, or press the numeric button(s), to select the preferred item.

- ◀▶/▲/▼ are not effective for selecting items for Video CDs.

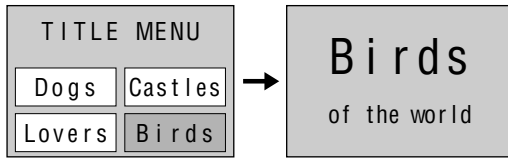

Play of the selected item now begins.

## When the menu continues onto another screen

After step 4 on page 14, press SKIP ▶▶|. (SKIP buttons may not be effective depending on the disc.)

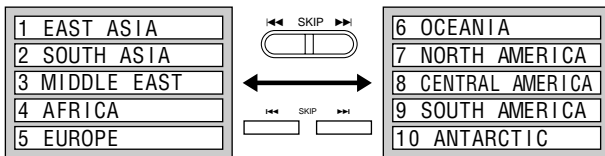

- To return to the previous menu screen  
Press ◀◀ SKIP.
- For operation, refer also to the jacket of the disc concerned.

## Stopping play and returning to the menu screen

- **DVD**  
Press TITLE, MENU or RETURN.  
(Which button is pressed differs depending on the disc used.)
- **Video CD**  
Press RETURN.
- Play is suspended, and the menu screen is displayed.

## After operation

When the unit is not in use, remove the disc and press POWER to switch the power to the standby mode.

The power will automatically be switched to the standby mode after 30 minutes or so have elapsed in the stop mode.

### (Auto turn-off function)

### What is playback control?

If a Video CD has "playback control" written on its disc or jacket, it means that particular scenes or information can be selected for viewing interactively with the TV monitor using the menu screen.

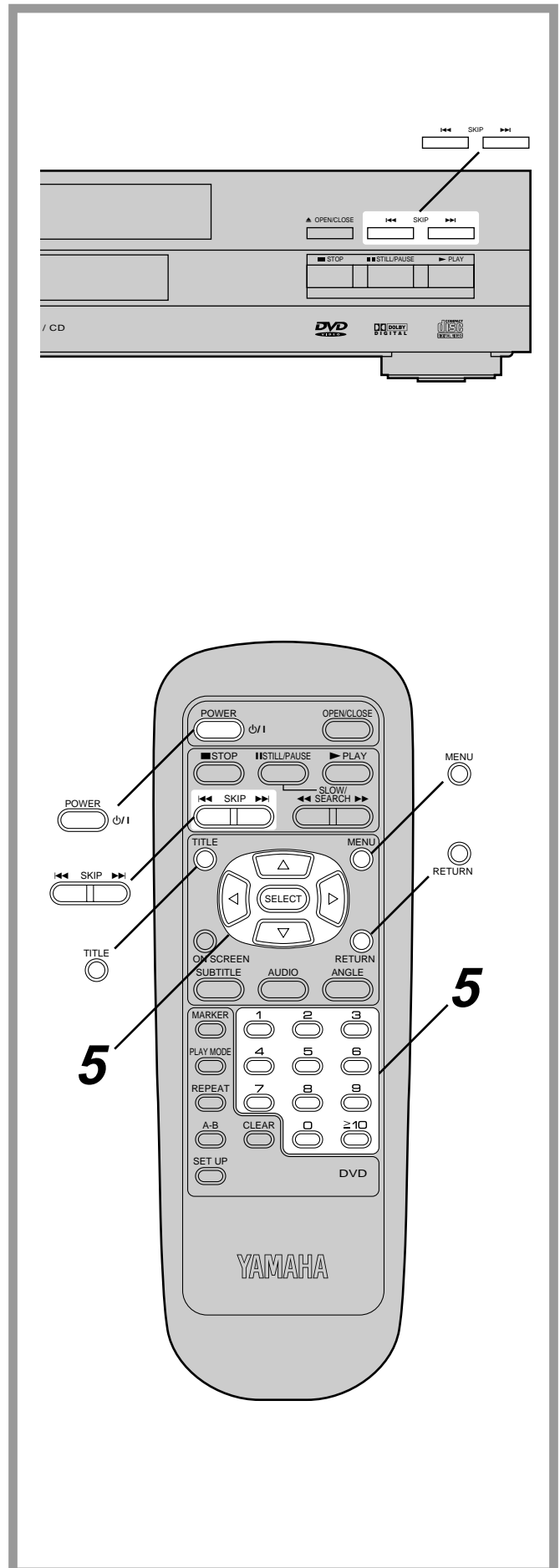

## Basic play

### Note:

- The disc continues to rotate while the menu is displayed even after the player has finished playing a particular item. When no further selections are to be played, be sure to press the STOP button to clear the menu display.
- If the disc is placed in upside down (and it is a single sided disc), the DVD display will indicate "NO DISC".

### For Continental Europe, United Kingdom and Australia models

- When the NTSC DVD/Video CD is played, the playback picture may roll up or down on some TVs; adjust this using the V-HOLD control on the TV. TVs not equipped with a V-HOLD control cannot correct this condition. The playback picture may shrink vertically and black bars may appear both on the top and bottom of the screen, or the picture may be in black and white. This does not indicate a malfunction.

### For your reference:

- When  appears while a button is being operated, it means that the corresponding operation is prohibited by the player or the disc.

## Stopping play

Press STOP.

### For your convenience:

- When play is stopped, the unit records the point where STOP was pressed (**RESUME function**). ("▶" flashes on the unit's display when this function is activated.) Press PLAY again, and play will resume from this point. When the tray is opened or STOP is pressed again, the RESUME function will be cleared.

The RESUME function works only with discs for which the elapsed playing time appears on the unit's display during playback.

This feature will not be cleared when the power is switched to the standby mode and then returned to ON.

## Skipping ahead or back

### Skipping ahead

Press **SKIP ▶▶** during play.

A chapter (DVD) or a track (Video CD/CD) is skipped each time the button is pressed.

### Skipping back

Press **◀◀ SKIP** during play.

When the button is pressed once midway through a chapter/track, play returns to the start of that chapter/track. When it is pressed again, a chapter/track is skipped each time the button is pressed.

### For your reference:

- When **◀◀ SKIP ▶▶** is pressed during menu play of Video CDs, a menu screen may sometimes be recalled.

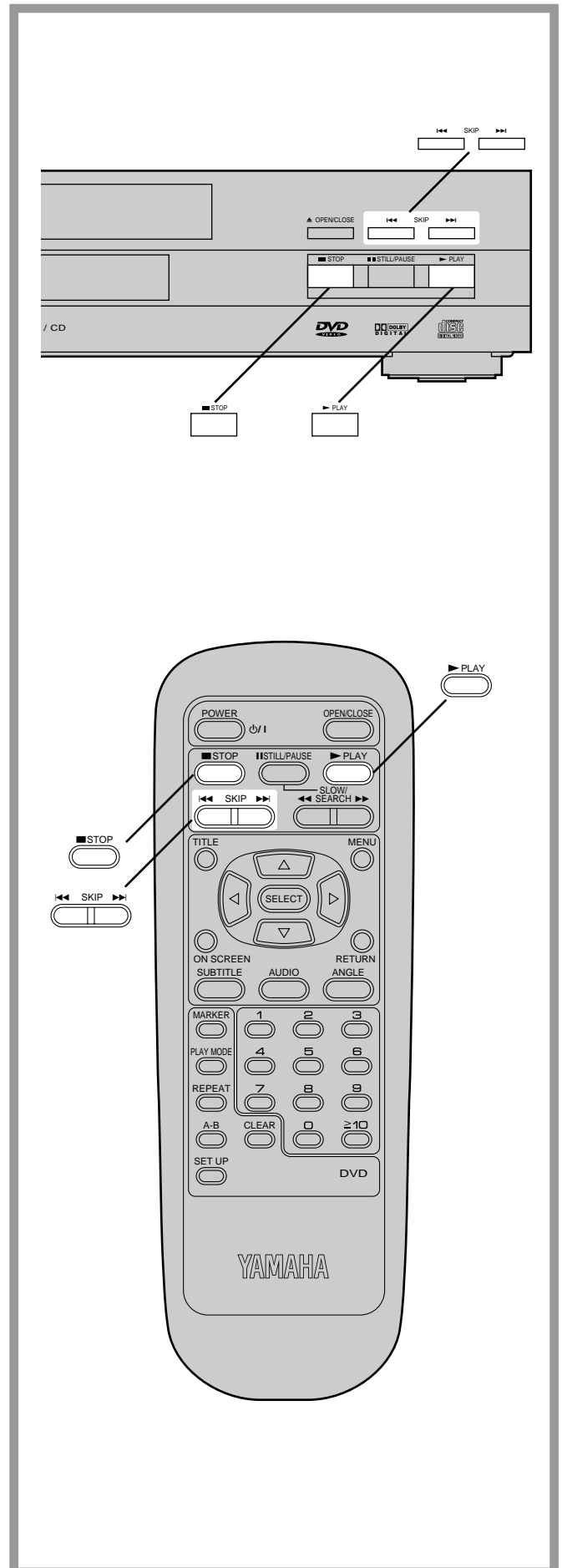



## Rapid advance (Rapid reverse)

Press **SLOW/SEARCH** ◀◀ or ▶▶ during play.

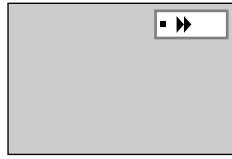
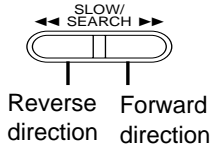

(Example)

- The speed of advance (reverse) is relatively slow at first. When the button is pressed again, the speed becomes faster. (Each time the button is pressed, the speed increases up to 5 steps.)

### To return to normal play

Press **PLAY**.

### For your reference:

- When **SLOW/SEARCH** is used during menu play of Video CDs, a menu screen may sometimes be recalled.

## Still picture (Pause)

Press **STILL/PAUSE** during play.

### •DVD/Video CD:

The player will be placed in the still picture mode.

### •CD:

The player will be placed in the pause mode.

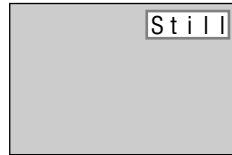

[DVD/Video CD]

### To return to normal play

Press **PLAY**.

## Frame advance [DVD/Video CD]

Press **STILL/PAUSE** in the still picture mode.

The disc is advanced by one frame each time the button is pressed.

### To return to normal play

Press **PLAY**.

### Note:

- Whether the pictures are advanced by a “frame” or “field” is selected automatically. (See page 41.)

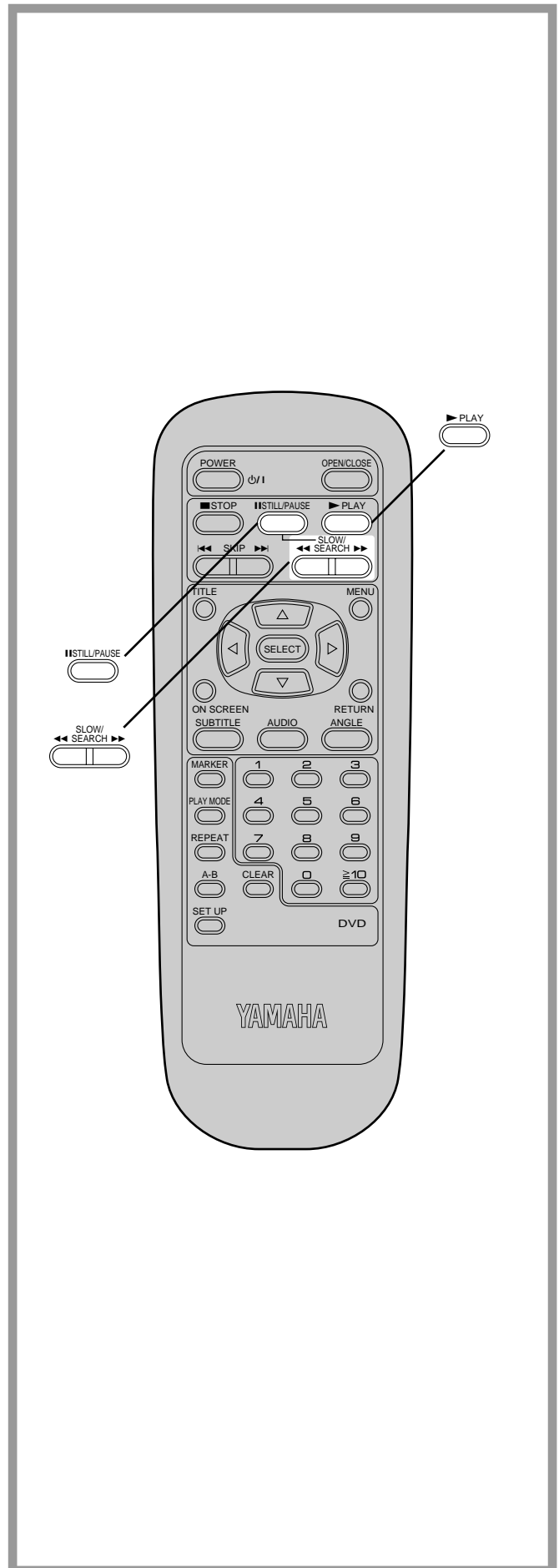

## Slow-motion play [DVD/Video CD]

Press **SLOW/SEARCH** ◀◀ or ▶▶ in the still picture mode. (See page 17.)

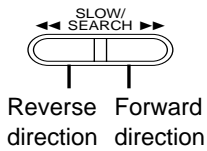

(Example)

- The speed of slow-motion is slow at first. When the button is pressed again, the speed becomes faster. (Each time the button is pressed, the speed increases up to 5 steps.)

### To return to normal play

Press **PLAY**.

### For your reference:

- For Video CDs, slow-motion playback in reverse direction is not possible.

## Enjoying Video CDs with playback control without using menus [Video CD only]

1. Press **STOP** after the menu screen appears (after step 4 on page 14).  
(“PBC” will be cleared from the unit’s display.)
2. Press the numeric button(s) to select the preferred track.  
(Play begins.)
  - Refer to the jacket etc. of the disc concerned for the track numbers.
  - Press “1” to start play from the beginning of the disc.

### To return to menu play

Press **STOP** to stop playback and press **MENU**. (“PBC” will light up on the unit’s display and the menu screen is resumed.)  
Perform step 5 on page 15.

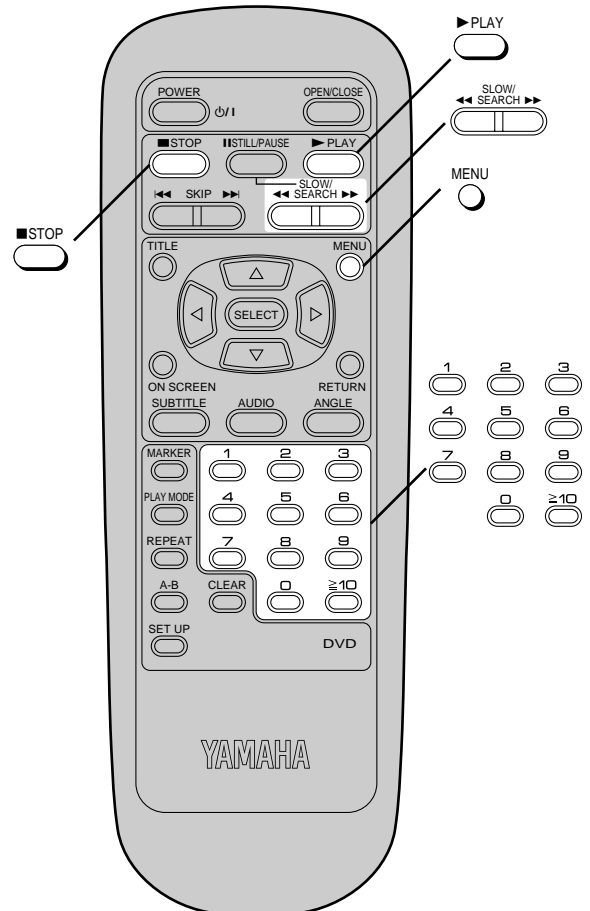

# General information about GUI screens

This unit features GUI (Graphical User Interface) screens consisting of icons showing disc information (title/chapter/track number, elapsed playing time, audio/subtitle language, and angle) and player information (repeat play, play mode, marker, Karaoke vocal ON/OFF, etc.).

Some icons only show the indicated information. Other icons allow the settings to be changed.

## Common procedures **A**

### 1 Press ON SCREEN during play or in the stop mode.

Each time this button is pressed, the TV monitor changes as shown below.

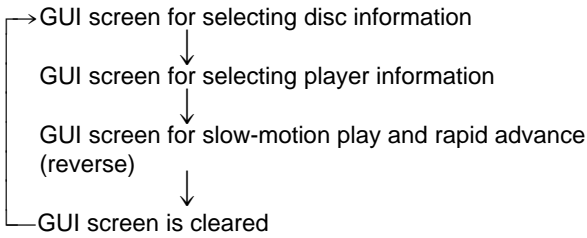

•Some functions cannot be accessed from the stop mode.

### 2 Press ◀/▶ to select the preferred item.

•The currently selected item is indicated by the yellow frame on the GUI screen.

### 3 Press ▲/▼ to select the preferred setting.

- When numbers are displayed (e.g. title No.), the numeric buttons are also effective for setting instead of ▲/▼.
- For some functions, the setting will be registered immediately; for others, SELECT must be pressed.

Press ON SCREEN, RETURN or CLEAR to clear the GUI screen.

### Example of GUI screens

(The screens may differ depending on the disc contents.)

- DVD **(B)**
- Video CD **(C)**
- CD **(D)**

### For your reference:

•Depending on the type of DVD software and a TV with automatic picture zoom function enabled, the GUI screen may not be displayed or only partially displayed on the TV screen.

In this case, select the appropriate TV screen type by consulting the operation manual of the TV.

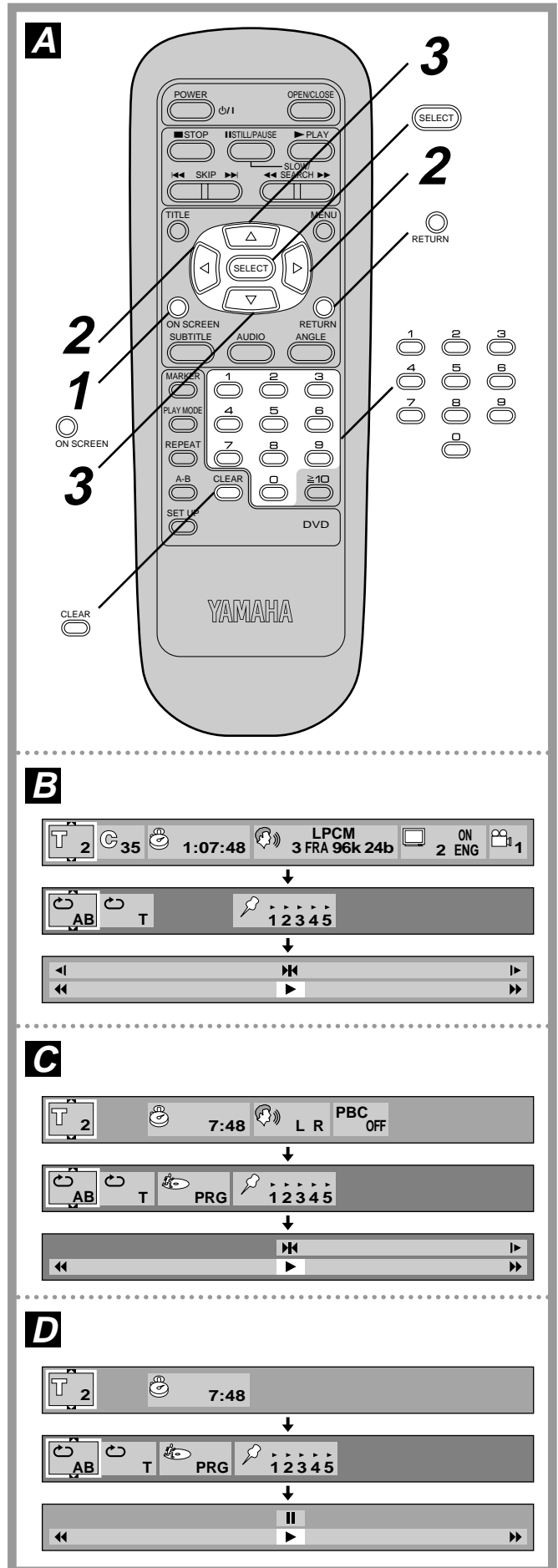

# Detailed descriptions of each GUI icon

## Screen for disc information

No.	Remarks	Changing method
①	To show the current title No. [DVD] or track No. [Video CD/CD] and to jump to the desired title No. or track No.*1	▲ ▼ or Numeric/SELECT
②	To show the current chapter No. or to jump to the desired chapter No. [DVD only]	▲ ▼ or Numeric/SELECT
③	To show the elapsed time and to directly select scenes by the elapsed time*2 [DVD] or to show the elapsed time [Video CD/CD]	Numeric/SELECT
④	To show the current audio soundtrack language No. and to change to the desired one [DVD only] (See page 28.)	▲ ▼ or Numeric
⑤	To show the audio soundtrack language selected using the above icon [DVD only]	—
⑥	To show the audio attribute (type) of the disc currently being played [DVD only] ●LPCM (Linear PCM), MPEG (MPEG audio) or  [Dolby Digital (AC-3)]	—
⑦	To show the audio attribute (sampling frequency or channel No.) of the disc currently being played [DVD only] ●For Linear PCM disc: 48 kHz or 96 kHz ●For Dolby Digital (AC-3) disc: 1ch to 5.1ch ●For MPEG audio disc: 1ch to 5.1ch	—
⑧	To show the audio attribute (bit No.) of the disc currently being played [DVD only] ●For Linear PCM disc: 16 bit to 24 bit	—
⑨	To show the number of recorded vocals [DVD Karaoke only] (See page 28.) ●1 vocal: ON or "----" (OFF) ●2 vocals: V1+V2, V1, V2 or "----" (OFF)	—
⑩	To show the current subtitles language No. and to change to the desired one [DVD only] (See page 27.)	▲ ▼ or Numeric
⑪	To show the subtitle language selected using the above icon [DVD only]	—
⑫	To display/clear subtitles [DVD only] (See page 27.)	▲ ▼
⑬	To show the current angle No. and to change to the desired one [DVD only] (See page 29.)	▲ ▼ or Numeric
⑭	To select the audio mode [Video CD only] (See page 28.) ●LR, L or R	▲ ▼
⑮	To show whether Video CD menu play is ON or OFF [Video CD with playback control only] (See pages 14, 15 and 18.)	—

●“▲ ▼” means pressing ▲/▼ and “Numeric” means pressing the numeric button.

\*1The track number cannot be selected during menu play of the Video CD.

\*2This function does not work with some DVDs.

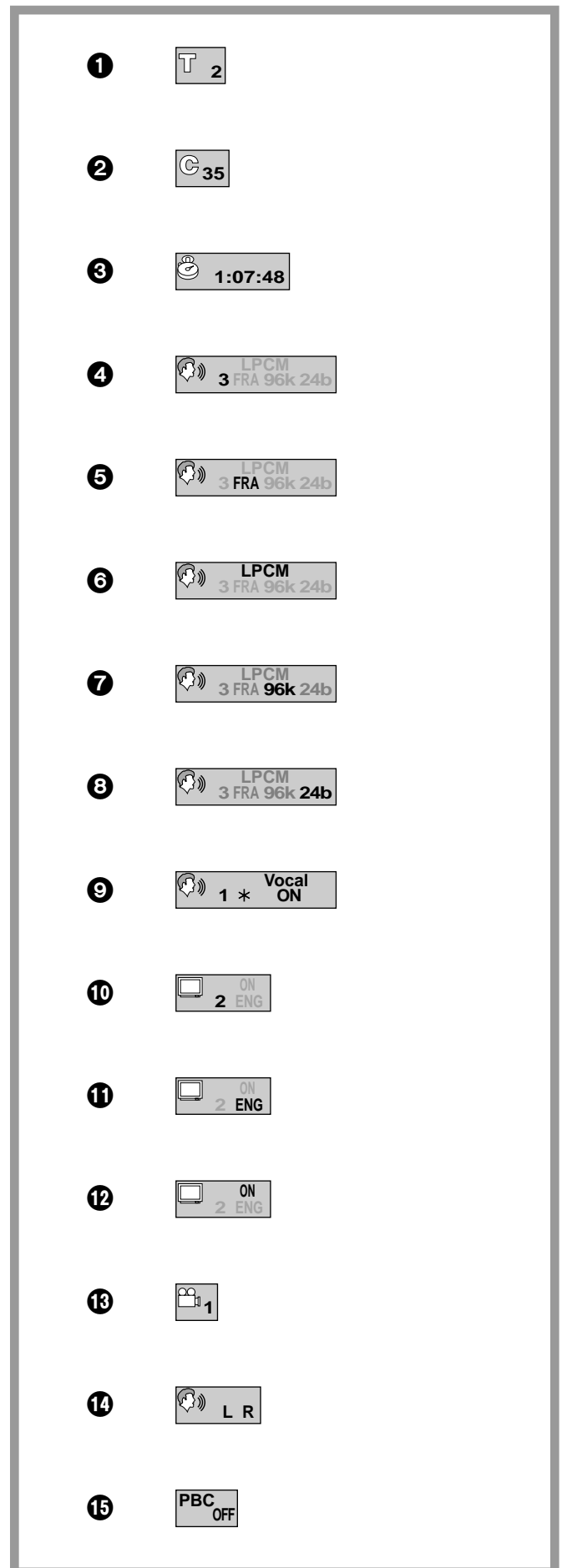

## Detailed descriptions of each GUI icon

### For your reference:

- For the language abbreviations used for the audio soundtrack and subtitle language icons, see the table **A**.

### Screen for player information **B**

No.	Remarks	Changing method
<sup>※1</sup> ①	To start A-B repeat play (See page 25.)	SELECT
<sup>※1</sup> ②	To select the repeat play mode (See page 24.) <ul style="list-style-type: none"> <li>● C (chapter repeat), T (title repeat) or OFF (normal play) [DVD]</li> <li>● T (track repeat), A (disc repeat) or OFF (normal play) [Video CD/CD]</li> </ul>	▲ ▼
③	To show the current play mode [Video CD/CD only] (See pages 22 and 23.) <ul style="list-style-type: none"> <li>● “----” (normal play), PRG (program play) or RND (random play)</li> </ul>	—
<sup>※1</sup> ④	To store a marker	SELECT
	To recall a marker	◀▶→▲
	To clear a marker	◀▶ →CLEAR
	(See page 26.)	

●“◀▶▲▼” means pressing ◀/▶/▲/▼.

※1This function does not work with an interactive DVD or during menu play of Video CD.

### Screen for slow-motion play and rapid advance (reverse) **C**

#### ① Still/Pause

Press ▲ to select “▶◀”.

#### ② Slow-motion play

Press ◀/▶.\*

◀I: Backward [DVD only]

I▶: Forward [DVD/Video CD only]

#### ③ Play

Press ▼ to select “▶”.

#### ④ Rapid reverse/advance

Press ◀ (Backward)/▶ (Forward).\*

\*Each time the button is pressed, the speed increases in up to 5 steps.

## A

ENG	English	FRA	French	DEU	German
ITA	Italian	ESP	Spanish	NLD	Dutch
SVE	Swedish	NOR	Norwegian	DAN	Danish
POR	Portuguese	RUS	Russian	JPN	Japanese
CHI	Chinese	KOR	Korean	MAL	Malay
VIE	Vietnamese	THA	Thai	*	Others

## B



## C

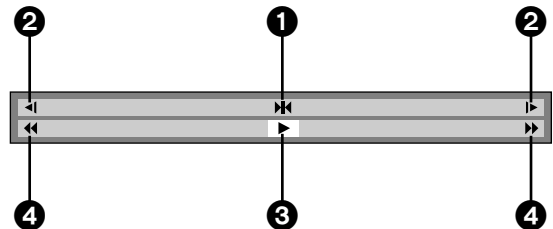

## Program play [Video CD/CD]

The player plays the tracks in the disc in an order you specify.

### 1 Press PLAY MODE in the stop mode.

The program playback screen appears on the TV monitor.

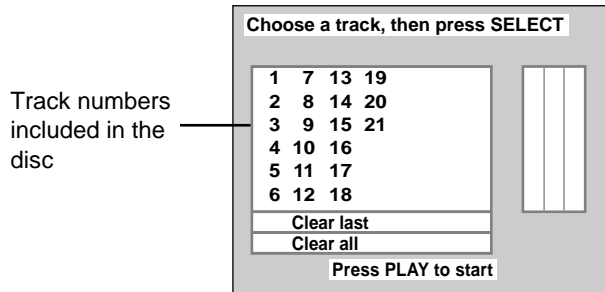

### 2 Press ◀▶/▲▼ and press SELECT, or press the numeric button(s), to select the preferred track number.

The selected track is stored in the memory.

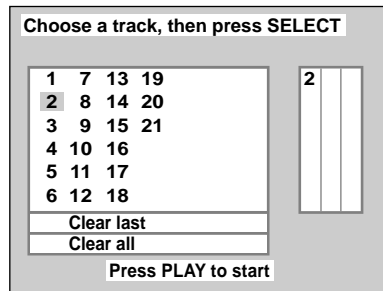

- Repeat step 2 to select another track.
- Up to 18 tracks can be programmed.

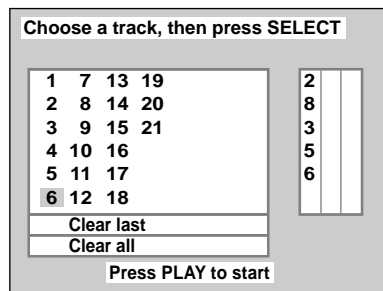

### 3 Press PLAY.

Play now begins in the programmed sequence.

#### After playback

Play is stopped and the program playback screen is displayed.

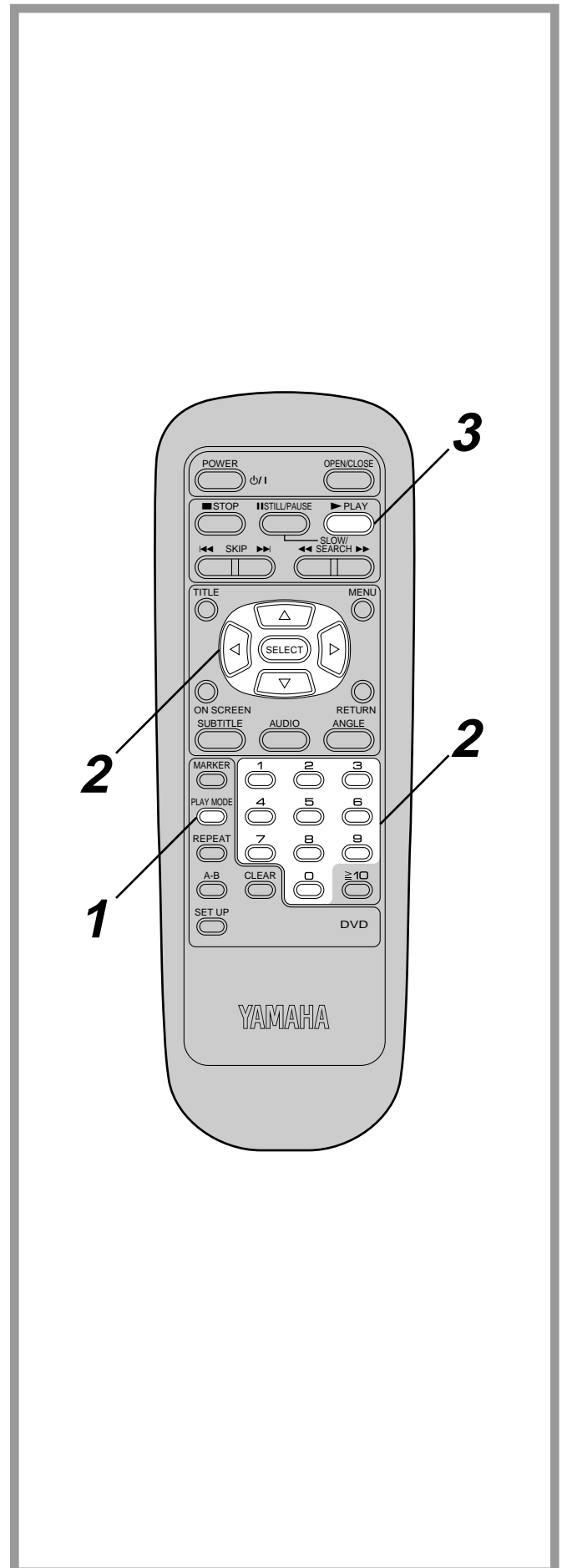

## Program play [Video CD/CD]

### Returning to normal play **A**

1. Press STOP. (Program play is suspended.)
2. Press PLAY MODE twice.
3. Press PLAY.

Normal play begins.

(The content of the program is still retained in the memory.)

### Clearing the program **A**

When the program playback screen is displayed

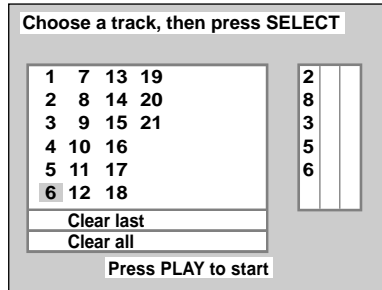

#### •To clear the last program one by one

Move to "Clear last" and press SELECT.

(Pressing CLEAR of the remote control unit also clears the last program.)

#### •To clear all the programs

Move to "Clear all" and press SELECT.

(The programs are also cleared when the power is switched to the standby mode or the disc is removed.)

## Random play [Video CD/CD] **B**

The player plays the tracks in the disc in random order.

### 1 Press PLAY MODE twice in the stop mode.

The random playback screen appears on the TV monitor.



### 2 Press PLAY.

Play now begins in the random order.

### After playback

Play is stopped and the random playback screen is displayed.

### Returning to normal play

1. Press STOP. (Random play is suspended.)
2. Press PLAY MODE.
3. Press PLAY.

Normal play begins.

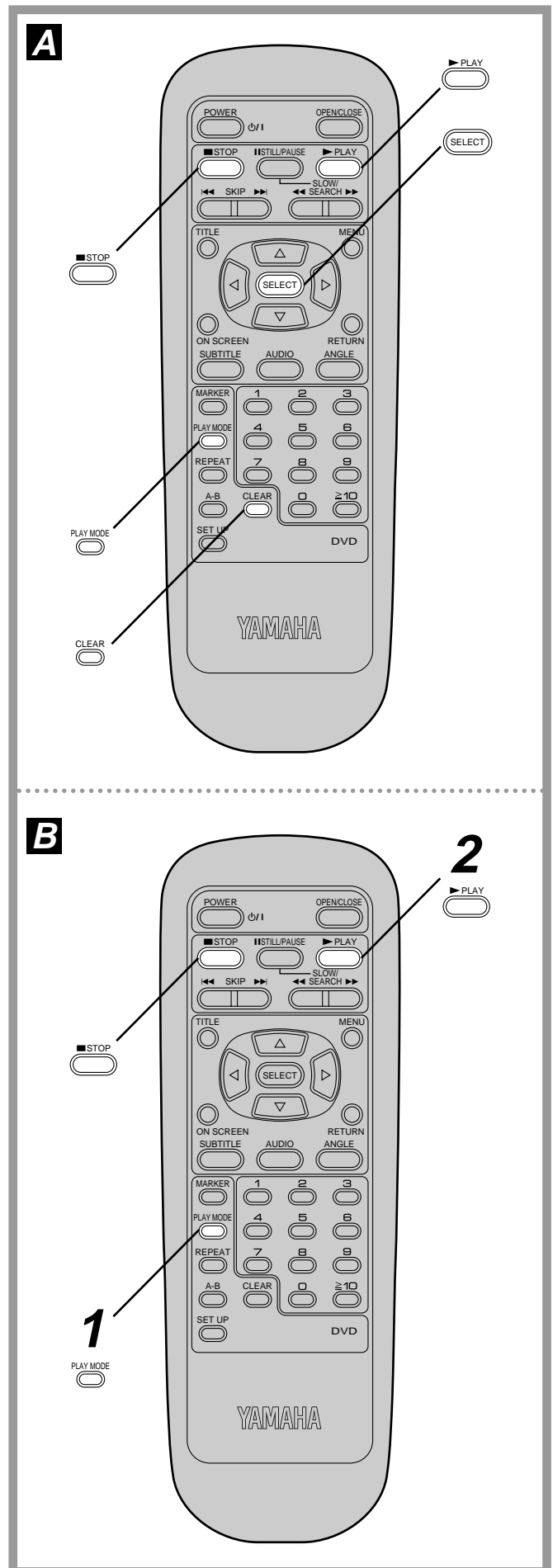

# Repeat play

## Repeat viewing (listening)

### Press REPEAT during play.

Each time this button is pressed, the TV monitor changes as shown below and the disc will repeat a chapter or title (DVD) or a track (Video CD/CD).

#### •DVD

Repeat of chapter being played

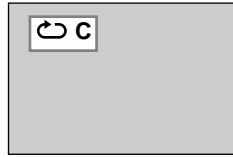

Repeat of title being played

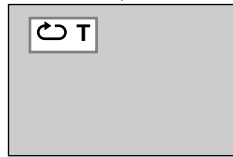

Cancel repeat mode  
(Normal play)

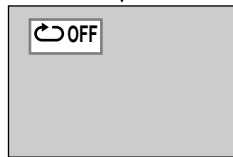

#### •Video CD/CD

Repeat of track being played

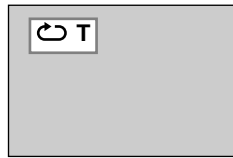

Repeat of entire disc contents

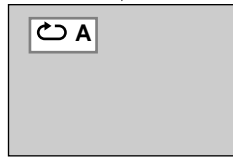

Cancel repeat mode  
(Normal play)

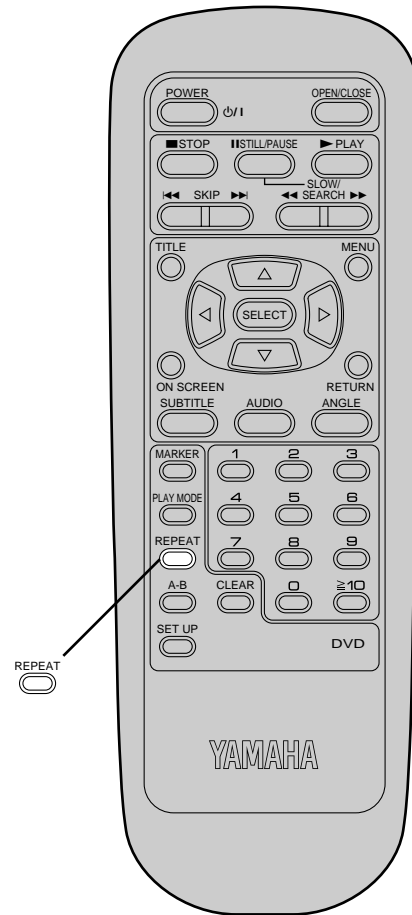
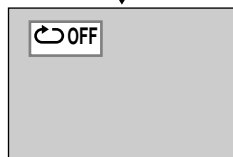

### To return to normal play

Press REPEAT several times until "OFF" is displayed.

#### Note:

- Repeat play works only with discs for which the elapsed playing time appears on the unit's display during playback.
- Repeat play may not work correctly with some DVDs.



## Repeat play

### To enjoy program repeat play

If REPEAT is pressed during program play (see pages 22 and 23), the display changes as follows:

Repeat of programmed track being played

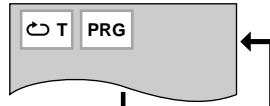

Repeat of all programs

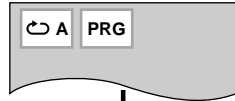

Cancel repeat mode (Normal program play)

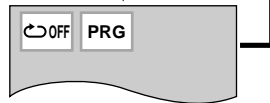

### Repeating sections between two specific points (A-B repeat)

**1** Press A-B during play at the point where repeat play is to commence (A).

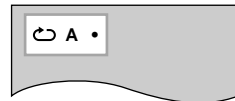

**2** Press A-B at the point where repeat play is to be concluded (B).

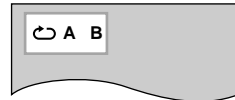

Repeat play of the selection between points A and B starts.

### To return to normal play

Press A-B several times until " ••" is displayed.

#### Note:

- A-B repeat play works only within a title [DVD] or a track [Video CD/CD].
- A-B repeat play works only with discs for which the elapsed playing time appears on the unit's display during playback.
- Some subtitles recorded around point A or B may fail to appear. [DVD]

**A**

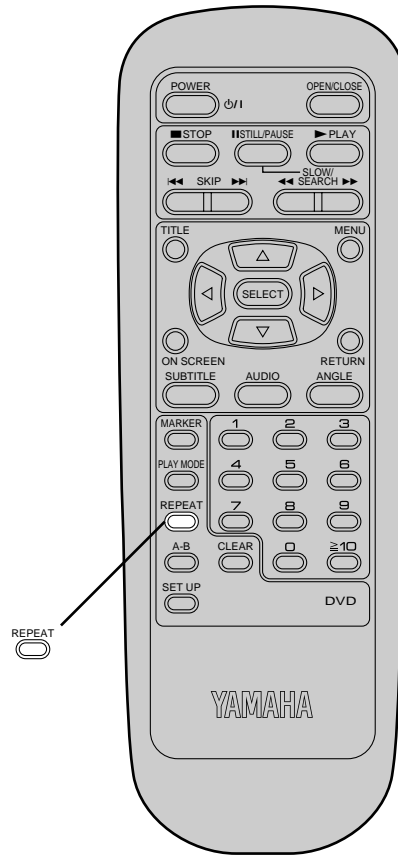

**B**

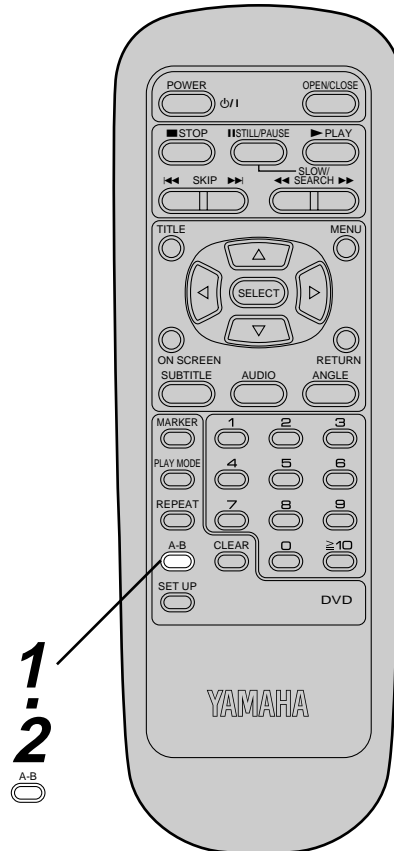

# Storing markers in memory to be viewed (listened) again

## Storing a marker in the memory **A**

**1** Press **MARKER** during play.

"\*" indicates no marker has been stored yet.

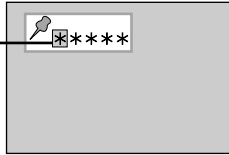

**2** Press **SELECT** during play at the starting point to be viewed (listened) again.

Indicates "MARKER 1" is stored in the memory. (If SELECT is pressed where any number is already displayed, the previous starting point will be replaced by the new one.)

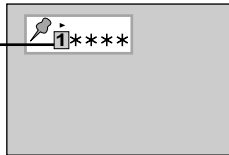

Up to 5 markers can be stored in the memory.

- To store markers 2 to 5, press ◀/▶ to move to "\*" and press SELECT.
- Press MARKER to clear the display.

## Recalling/clearing a marker **B**

**1** Press **MARKER** during play.

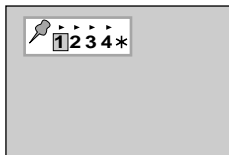

**2** Press ◀/▶ to select the marker to be recalled/cleared.

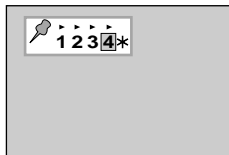

**3** Press ▲ to recall a marker.

or

Press **CLEAR** to clear a marker.

Play resumes from the point corresponding to the selected marker. (The display will be cleared automatically.)

or

The selected marker is cleared. (Press MARKER to clear the display.)

### Note:

- These operations work only with discs for which the elapsed playing time appears on the unit's display during playback.
- Some subtitles recorded around the marker may fail to appear. [DVD]

### For your reference:

- All the markers are cleared when the unit is switched to the standby mode or the disc tray is opened.

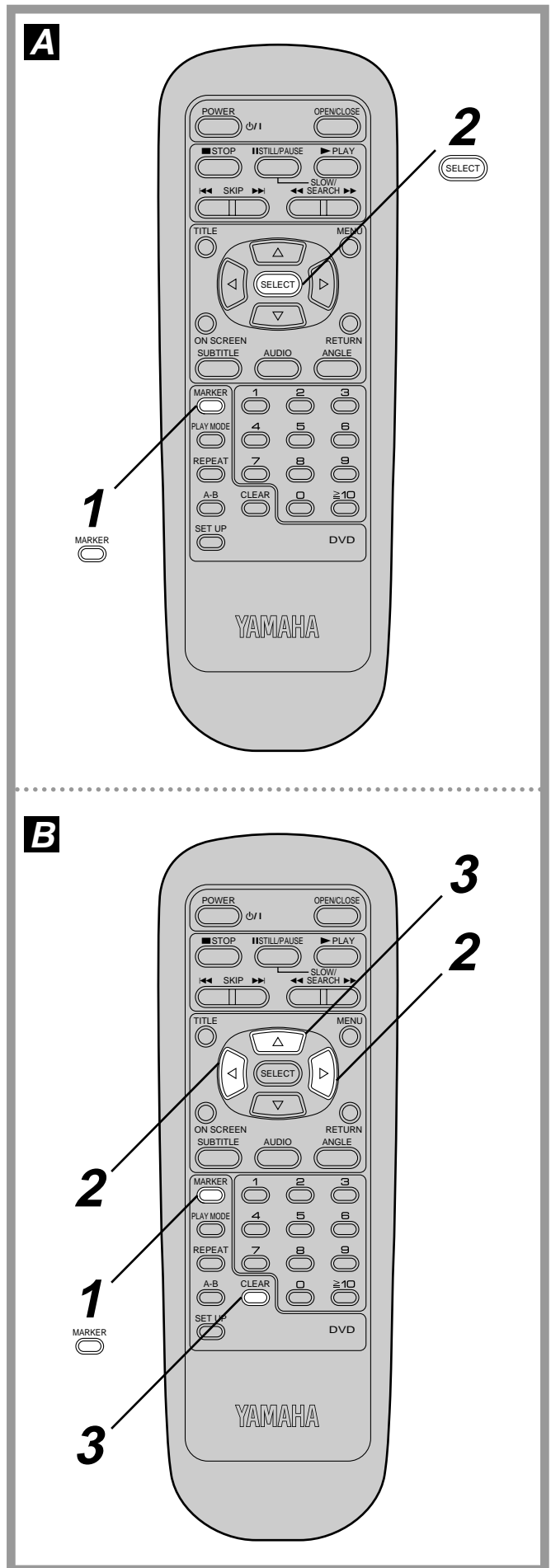

# Changing subtitle language

## [DVD only]

It is possible to change the subtitle language from the one selected at the initial settings to a different language, if available. (See page 32.)

(This operation works only with discs on which multiple subtitle languages are recorded.)

### 1 Press **SUBTITLE** during play.

- When no subtitles are recorded, “-” will be displayed instead of the language number.

Number of the subtitle language being played back

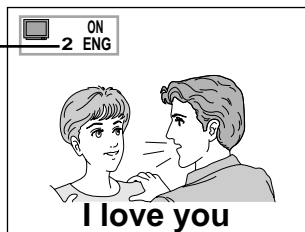

### 2 Press **▲/▼** until the preferred language is selected.

Pressing the numeric button(s) also changes the subtitle language.

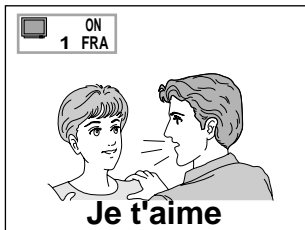

- Press **SUBTITLE** or **SELECT** to clear the display.

### To clear/display the subtitles

Press **◀/▶** to select ON or OFF at the step 2.

#### Note:

- In some cases, the subtitle language is not changed immediately to the selected one.

#### For your reference:

- When the preferred language is not selected even after pressing the button several times, it means that the language is not available on the disc.
- When the unit is switched to the standby mode or the disc tray is opened, subtitles appear in the language selected at the initial settings. If this language is not recorded on the disc, they appear in the disc's priority language.

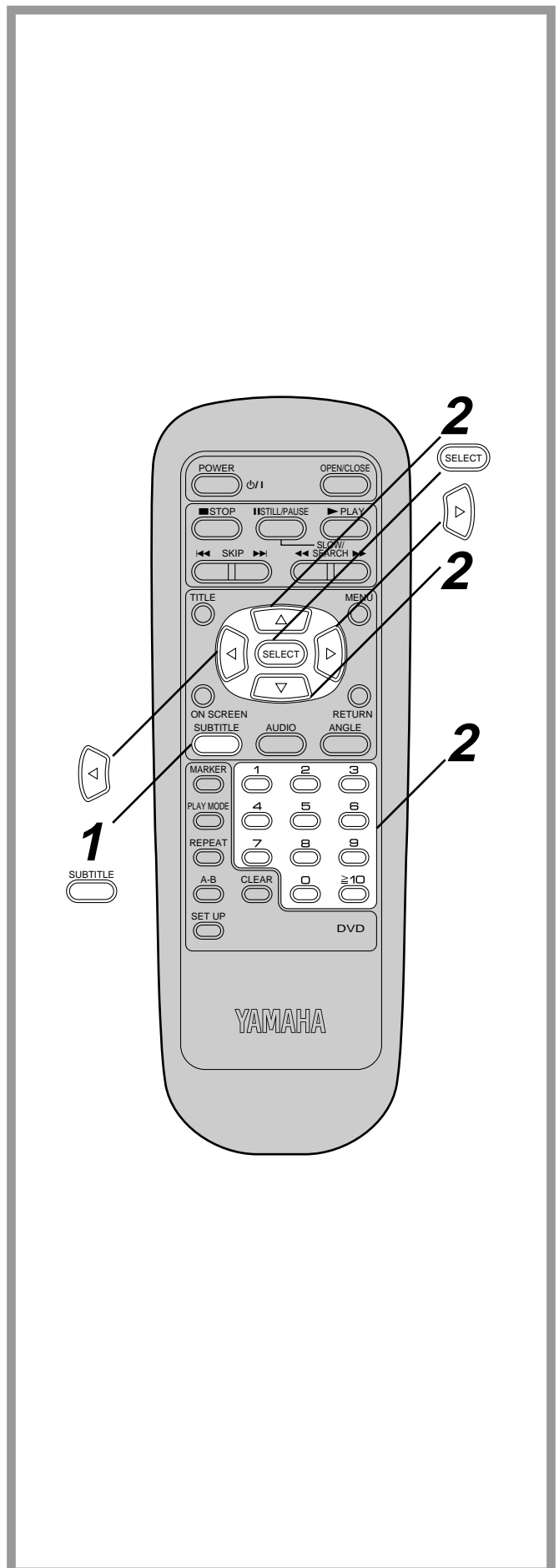

## Changing audio soundtrack language [DVD only]

It is possible to change the audio soundtrack language from the one selected at the initial settings to a different language, if available. (See page 32.)

(This operation works only with discs on which multiple audio soundtrack languages are recorded.)

### 1 Press AUDIO during play.

- When no audio soundtrack is recorded, “-” will be displayed instead of the language number.

Number of the audio soundtrack language being played back

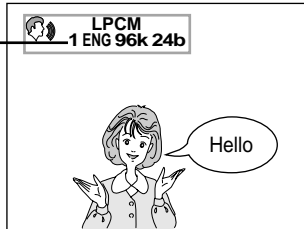

### 2 Press ▲/▼ until the preferred language is selected.

Pressing the numeric button(s) also changes the audio soundtrack language.

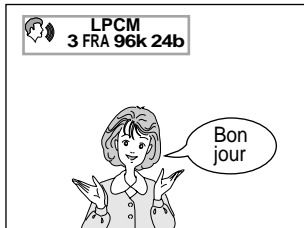

- Press AUDIO or SELECT to clear the display.

#### For your reference:

- When the preferred language is not selected even after pressing the button several times, it means that language is not available on the disc.
- When the unit is switched to the standby mode or the disc tray is opened, the language heard is the one selected at the initial settings. If this language is not recorded on the disc, only the available language on the disc will be heard.

## Switching vocals ON or OFF for Karaoke discs [DVD/Video CD]

### 1 Press AUDIO during play.

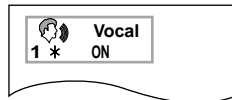

### 2 Press ◀/▶ until the preferred setting is selected.

- DVD Karaoke (1 vocal)  
ON ↔ ---- (OFF)



- DVD Karaoke (2 vocals)  
1+2 → V1 → V2 → ---- (OFF)

- Video CD  
LR → L → R



- Press AUDIO or SELECT to clear the display.

#### Note:

- This operation does not work with CDs.

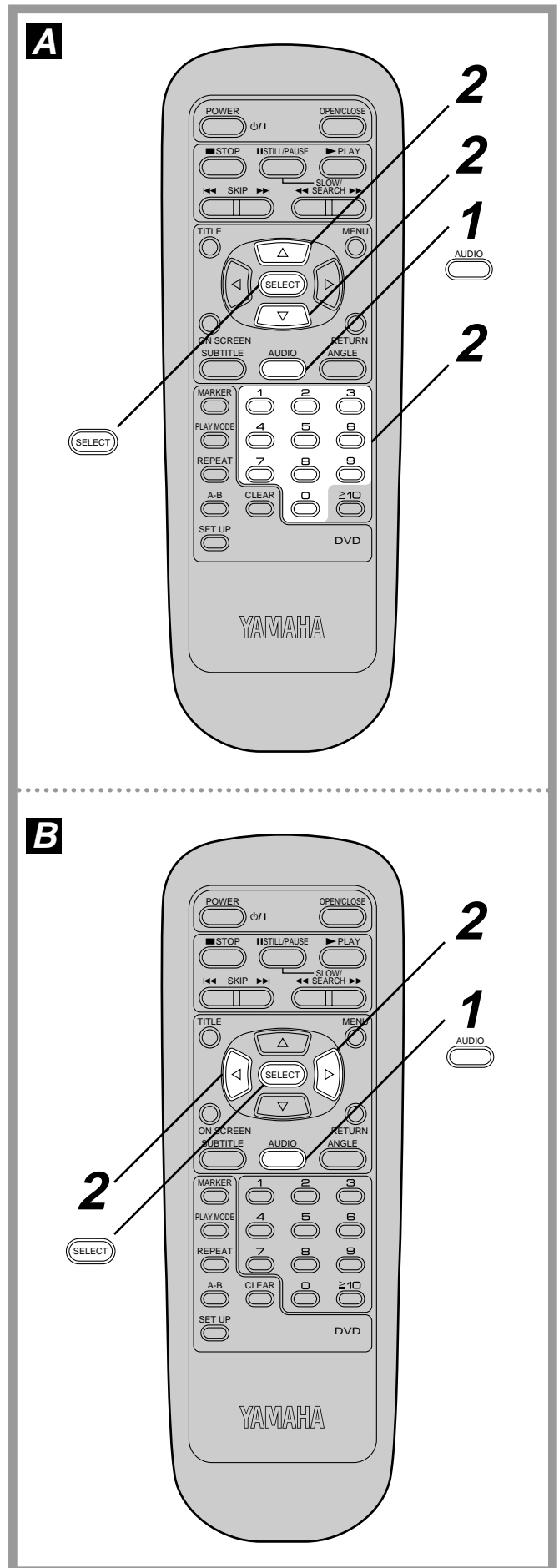

# Viewing from another angle

## [DVD only]

Some DVDs may contain scenes which have been shot simultaneously from a number of different angles. For these discs, the same scene can be viewed from each of these different angles using the ANGLE button. (The recorded angles differ depending on the disc used.)

### 1 Press ANGLE during play.

Number of angle being played back

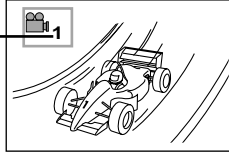

### 2 Press ▲/▼ until the preferred angle is selected.

Pressing the numeric button(s) also changes the angle.

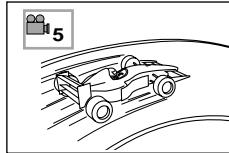

- Press ANGLE or SELECT to clear the display.

#### Note:

- This function only works for discs having scenes recorded at different angles.
- "ANGLE" lights up on the FL display at scenes recorded at different angles to indicate that angle switching is possible. The angle number can be programmed beforehand; the angle will be switched to the selected number when "ANGLE" lights up.

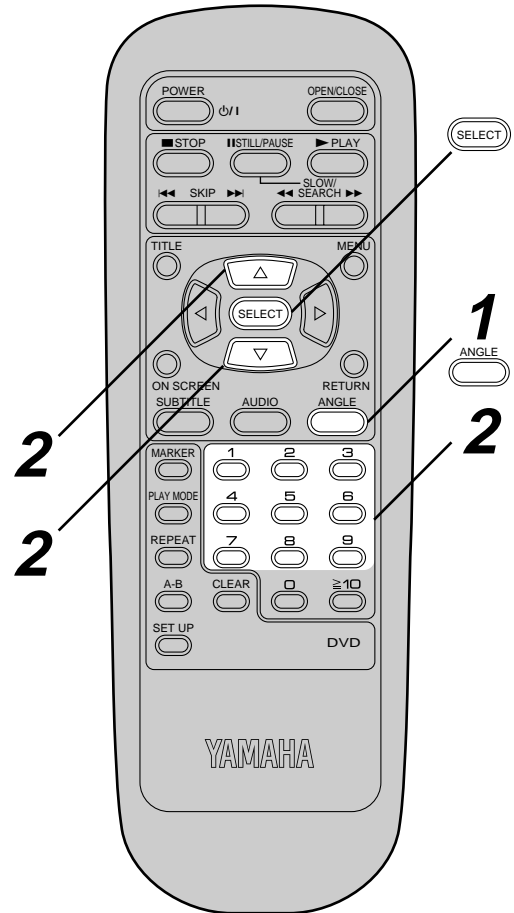

## Using a title menu [DVD only]

Some discs with movies, for example, may be available with two or more titles. If the disc has a title menu recorded on it, the TITLE button can be used to select the movie title. (The details of operation differ depending on the disc used.)

### 1 Press TITLE during play.

A list of the titles on the disc is now displayed.

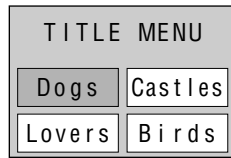

(Example)

- Pressing TITLE again resumes play from the scene when TITLE was first pressed.

### 2 Press ◀▶/▲/▼ and press SELECT or PLAY, or press the numeric button(s), to select the preferred title.

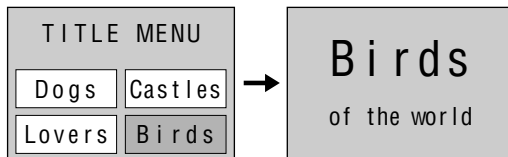

The selected title now starts playing.

## Using a DVD menu [DVD only]

Some DVDs have unique menu structures called DVD menus. For example, DVDs programmed with complex contents provide guide menus, and those recorded with various languages provide menus for audio and subtitle language. Although the DVD menu's contents and operation differ from disc to disc, the following explains basic operation when this feature is used.

### 1 Press MENU during play.

The DVD menu available on the disc is now displayed.

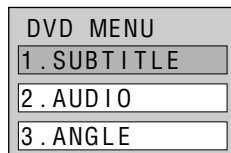

(Example)

- Pressing MENU again resumes play from the scene when MENU was first pressed.

### 2 Press ◀▶/▲/▼ and press SELECT, or press the numeric button(s), to select the preferred item.

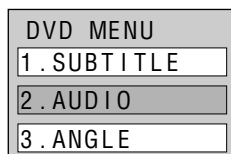

The selected item is now executed.

### When the menu continues onto another screen

Repeat step 2.

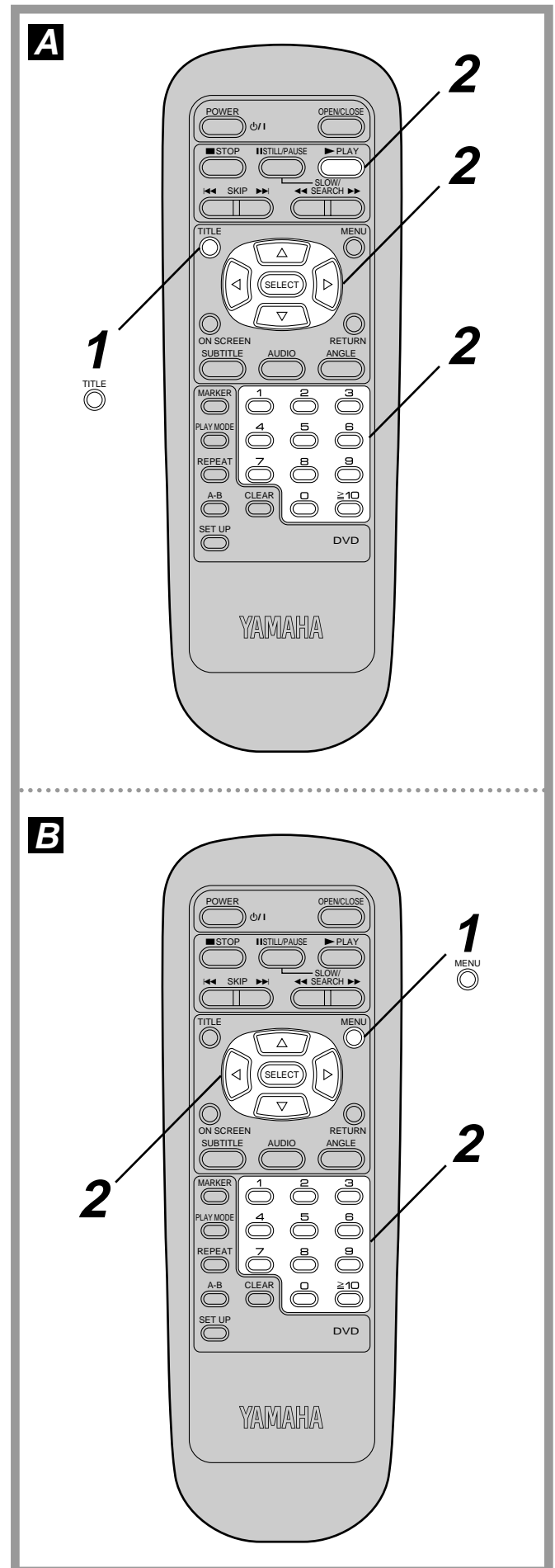

# Initial settings

Once the initial settings have been completed, the player can always be operated under the same conditions (especially with DVD discs).

The settings will be retained in the memory even after switching the power to the standby mode until the settings are changed.

## Common procedures of initial settings

### 1 Press SET UP in the stop mode.

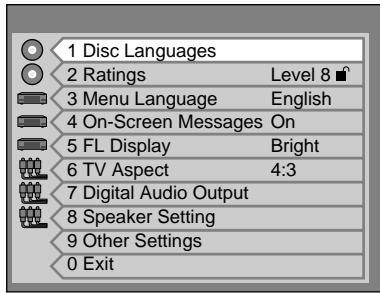

### 2 Press ▲/▼ to select the preferred item and SELECT.

Each screen for setting the value is displayed.

- 1 Disc Languages (see page 32)
- 2 Ratings (see page 33)
- 3 Menu Language (see page 34)
- 4 On-Screen Messages (see page 35)
- 5 FL Display (see page 35)
- 6 TV Aspect (see page 36)
- 7 Digital Audio Output (see page 37)
- 8 Speaker setting (see page 39)
- 9 Other Settings (see page 41)

### 3 Press ▲/▼ to select the preferred value and press SELECT.

- Some items require additional steps. (See the respective page.)

Setting is finished and the initial settings screen is displayed.

#### To cancel during setup operation

Press RETURN or select "0". (The previous screen is displayed.)

#### To clear the initial settings screen

Press ▼ to select "0" and press SELECT. (Pressing SET UP or RETURN also clears the initial settings screen.)

#### For your reference:

- The numeric buttons can also be used for selecting items or values instead of ▲/▼; in this case, pressing SELECT is not necessary.

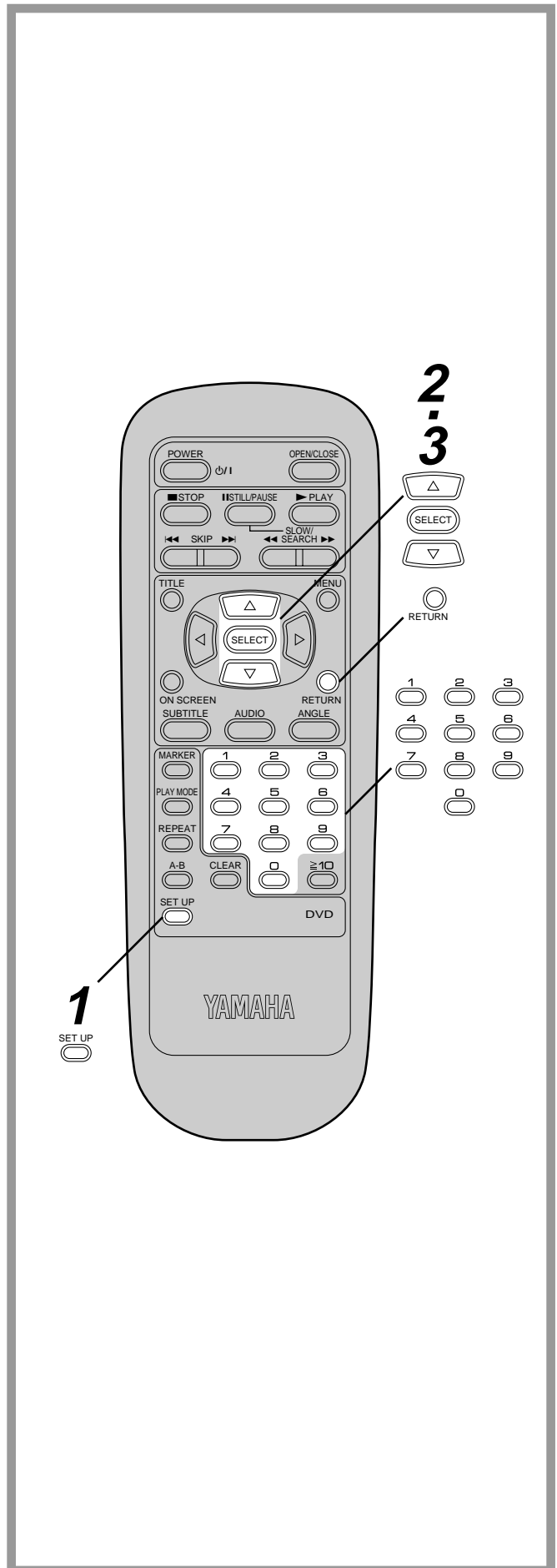

## Initial settings

### Selecting disc languages [DVD only]

This is to select the audio soundtrack language, subtitle language and the language used in title menus or DVD menus which will always be used for every disc to be played back.

- 1 At the initial settings screen  
Press ▲/▼ to select “1 Disc Languages” and press SELECT.



- 2 Press ▲/▼ to select the preferred item (1–3) and press SELECT.

#### When “1 Audio” is selected

**English:** English is selected (Factory setting)

**French/German/Italian/Spanish:\***

Each language is selected.

**Original:** The original language of each disc will be selected.

**Other \*\*\*\*\*:** Another language can be selected.  
(Refer to the language codes on page 43. Press CLEAR if an incorrect language code is entered.)

#### When “2 Subtitle” is selected

**Automatic:** The same language selected for the “Audio” will be selected. (Factory setting)

- If the language selected for the “Audio” is actually used during playback, the subtitles will not appear.
- If another language is used during playback, the subtitles will appear in the language selected at the setup “Audio”.

**English/French/German/Italian/Spanish:\***

Each language is selected.

**Other \*\*\*\*\*:** Another language can be selected.

#### When “3 Menu” is selected

**English:** English is selected (Factory setting)

**French/German/Italian/Spanish:\***

Each language is selected.

**Other \*\*\*\*\*:** Another language can be selected.

\*German and Italian can be selected only in Continental Europe, United Kingdom and Australia models.

- 3 Press ▲/▼ to select the preferred language at each screen and press SELECT.

The screen at the step 1 is displayed. Press ▼ to select “0” and press SELECT to return to the initial settings screen.

#### Note:

- If the language selected is not available on the disc, the language designated by each disc will be selected.

Also refer to “Common procedures of initial settings” on page 31.

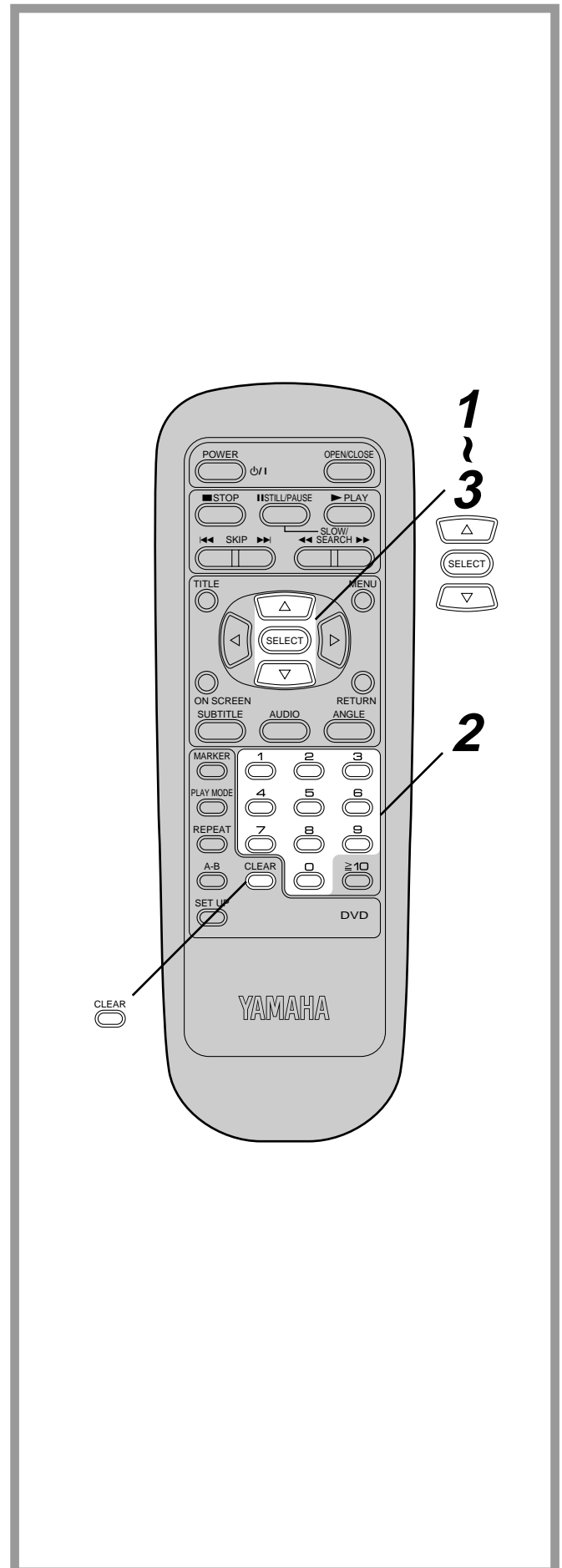



## Initial settings

### Selecting rating level [DVD only]

This is to disable the playing of specified DVDs which are unsuitable for children.

- Some DVDs are encoded with specific rating level. If the rating level of the disc is higher than that preset in the setup operation, playback of the disc will be prohibited.

#### 1 At the initial settings screen

Press **▲/▼** to select “2 Ratings” and press **SELECT**.

All DVDs can be played back. (Factory setting)

DVDs for general audiences/children can be played back. (DVDs for adults are prohibited.)

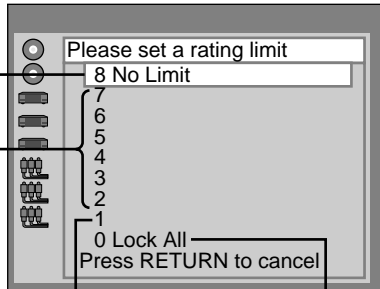

DVDs for children can be played back. (DVDs for adults/general audiences are prohibited.)

Playback of all DVDs is prohibited. (e.g. to prohibit playback of DVDs for adults which are not encoded with rating level information)

#### 2 Press **▲/▼** to select the preferred level and press **SELECT**.

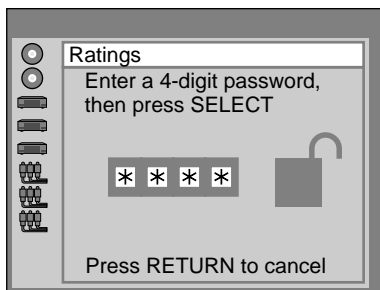

#### 3 When level 7 or lower is selected Input a 4-digit password and press **SELECT**.

The lock symbol appears closed to show the rating is locked.

Example: “4343”  
Do not forget your password.



#### 4 Press **SELECT**.

Setting is finished and the initial settings screen is displayed.

- The rating is locked. Any discs whose rating is higher than the setting cannot be played back unless the correct password is entered.

Also refer to “Common procedures of initial settings” on page 31.

(Continued on the next page)

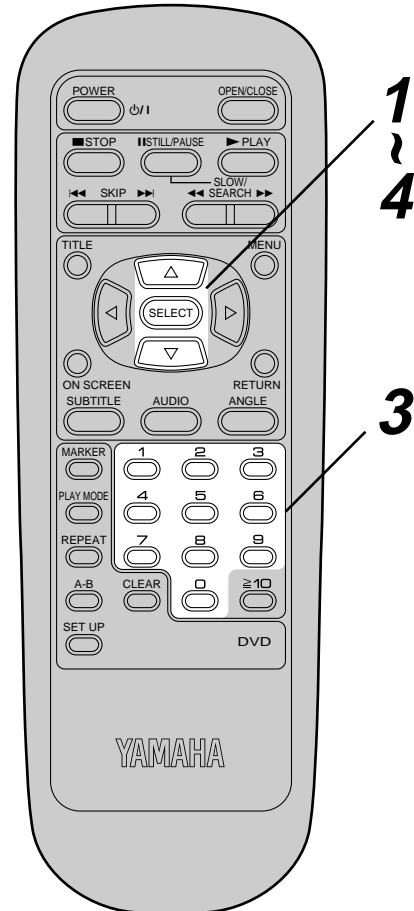

## Initial settings

### To change the settings **A**

1. Press ▲/▼ to select "2" at the initial settings screen and press SELECT.



2. Input a 4-digit password and press SELECT.

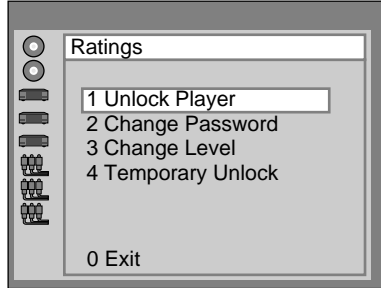

3. Press ▲/▼ to select the preferred item (1–4) and press SELECT.
  - Press ▼ to select "0" and press SELECT to exit. (Setting is finished and the initial settings screen is displayed.)
4. **When "1 Unlock Player" is selected**  
Press SELECT.
- When "2 Change Password" is selected**  
Enter a new 4-digit password and press SELECT. Press SELECT again.
- When "3 Change Level" is selected**  
Select a level and press SELECT.
- When "4 Temporary Unlock" is selected**  
(The rating is unlocked temporarily only for the current disc.)  
Press SELECT.

Setting is finished and the initial settings screen is displayed.

#### Note:

- Some discs may not be encoded with specific rating level information though its disc jacket says that it is for "adults". For those discs, the age restriction will not work.

### Selecting language of On-Screen Display menu **B**

- 1 At the initial settings screen  
Press ▲/▼ to select "3 Menu Language" and press SELECT.

Factory settings

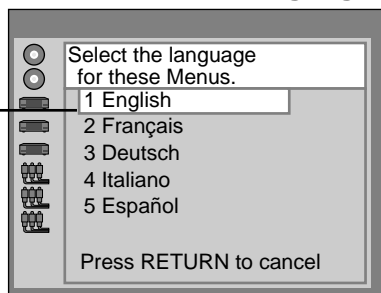

- 2 Press ▲/▼ to select the preferred language and press SELECT.

\*German and Italian can be selected only in Continental Europe, United Kingdom and Australia models.

Setting is finished and the initial settings screen is displayed.

Also refer to "Common procedures of initial settings" on page 31.

### A

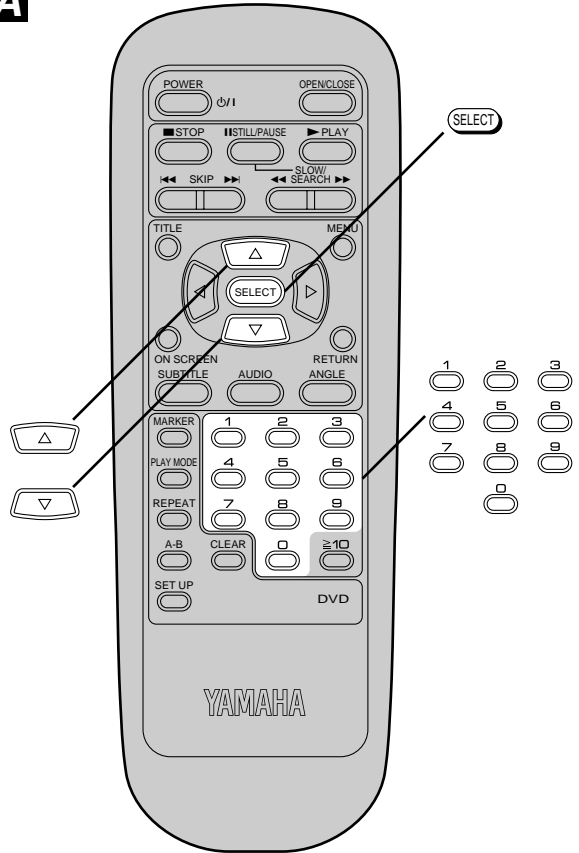

### B

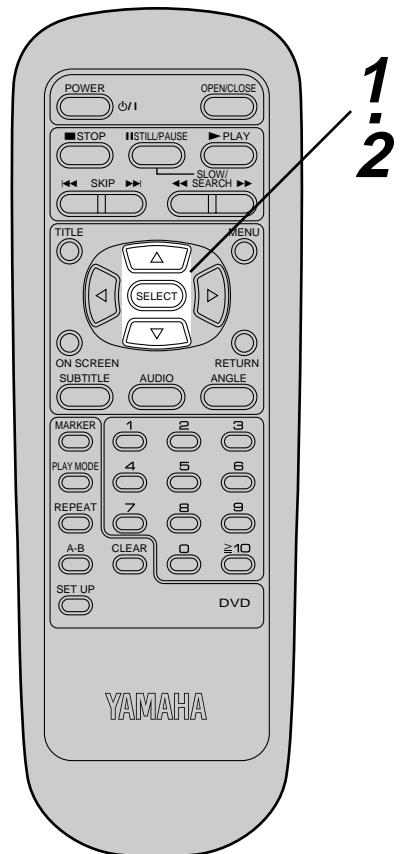

## Initial settings

### Switching the On-Screen Display ON or OFF **A**

You can select whether On-Screen Display messages such as PLAY and STOP will be displayed or not.

- 1 At the initial settings screen  
Press ▲/▼ to select “4 On-Screen Messages” and press SELECT.

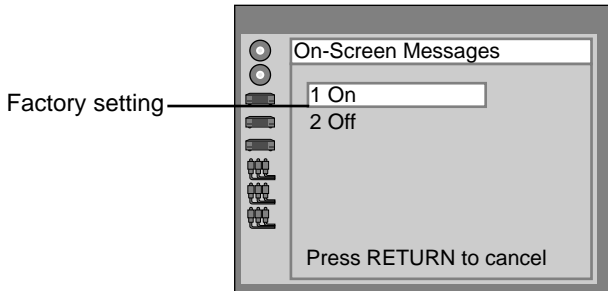

- 2 Press ▲/▼ to select the preferred item (1 or 2) and press SELECT.

Setting is finished and the initial settings screen is displayed.

### Selecting the display brightness **B**

- 1 At the initial settings screen  
Press ▲/▼ to select “5 FL Display” and press SELECT.

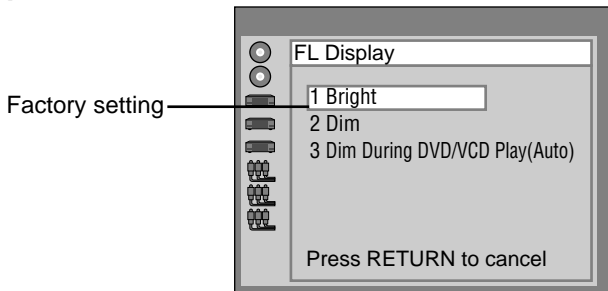

- 2 Press ▲/▼ to select the preferred item (1–3) and press SELECT.

Setting is finished and the initial settings screen is displayed.

#### For your reference:

- Even if “3 Dim During DVD/VCD Play (Auto)” is selected, the display resumes brightness when a button for special play such as SLOW/SEARCH and STILL/PAUSE is pressed.

Also refer to “Common procedures of initial settings” on page 31.

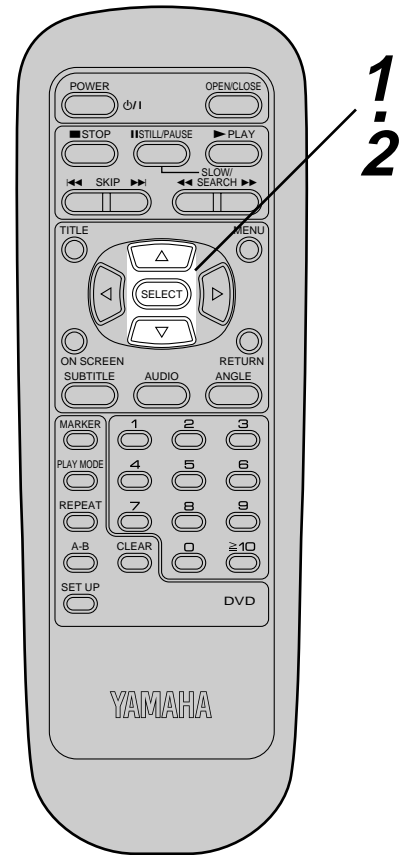
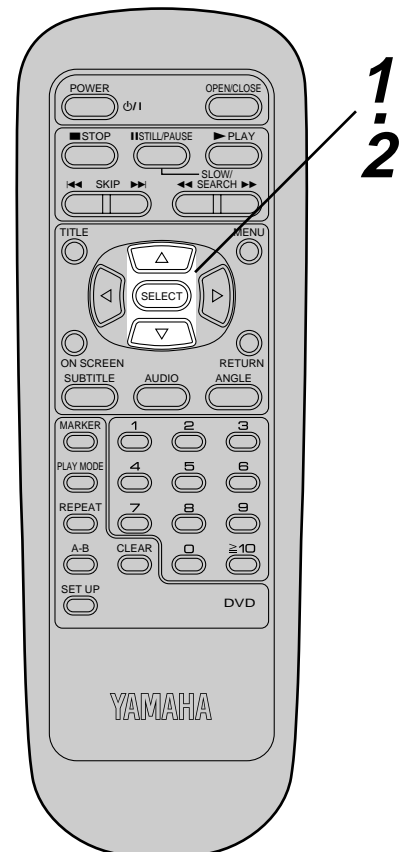
**A****B**

## Initial settings

### Selecting TV screen type

Select the appropriate screen type according to your TV set; conventional size screen (4:3) or wide-screen (16:9).

#### 1 At the initial settings screen

Press ▲/▼ to select “6 TV Aspect” and press SELECT.

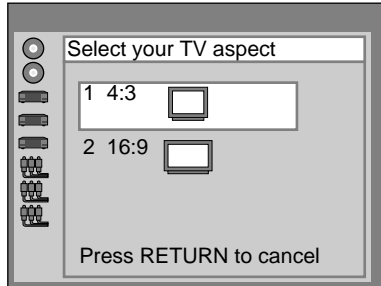

#### 2 Press ▲/▼ to select the preferred item (1 or 2) and press SELECT.

4:3  Select when a conventional TV set is connected. (factory setting)

The video material formatted in the Pan & Scan style is played back in that style (the left and right edges are cut off).

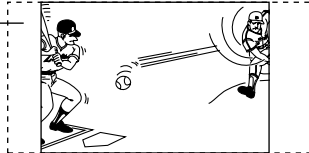

The video material not formatted in the Pan & Scan style is played back in the letterbox style (black bands appear at top and bottom of screen).

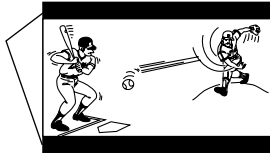

16:9  Select when a wide-screen TV set is connected.

Played in “FULL” size. (Setting the wide-screen TV to “FULL” mode is also necessary.)

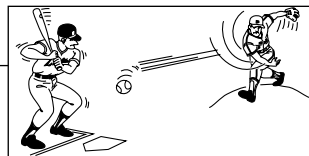

※ Each screen shows an example when the video material for a wide-screen is played. (This setting does not affect the video material for conventional size.)

Setting is finished and the initial settings screen is displayed.

Also refer to “Common procedures of initial settings” on page 31.

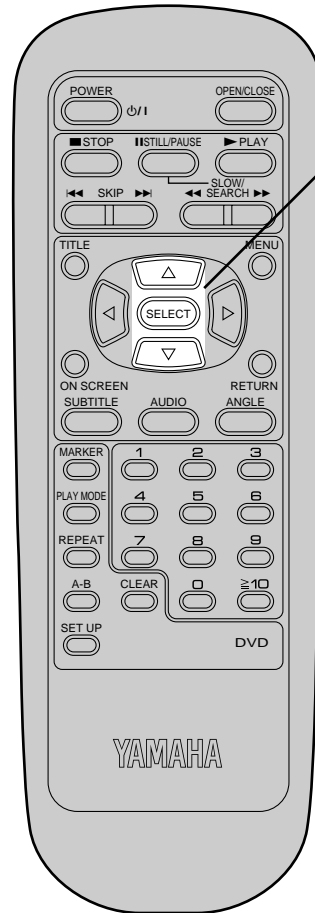

## Initial settings

### Selecting digital output

Select the digital output to be output from the optical/coaxial digital audio output connector of the unit.

- 1** At the initial settings screen  
Press **▲/▼** to select “7 Digital Audio Output” and press **SELECT**.

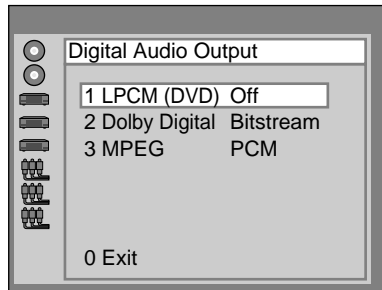

- 2** Press **▲/▼** to select the preferred item (1–3) and press **SELECT**.

#### When “1 LPCM (DVD)” is selected

**Off:** Only linear PCM of 48 kHz/16 bit is output from the digital audio output connector. During playback of the DVD recorded in the linear PCM of 48 kHz/20 bit/24 bit or 96 kHz, no digital audio is output. (Factory setting)

**PCM:** During playback of the DVD recorded in the linear PCM of 48 kHz/20 bit/24 bit or 96 kHz, digital audio converted to 48 kHz/16 bit is output. (Digital output of PCM audio is restricted to 48 kHz/16 bit or below for copyright protection.)

#### When “2 Dolby Digital” is selected

**Bitstream:** Dolby Digital (AC-3) bitstream (2ch–5.1ch) is output. (Factory setting)

**PCM:** PCM (2ch) of 48 kHz/16 bit is output.

#### When “3 MPEG” is selected

**PCM:** PCM of 16 bit is output. (Factory setting)

**Bitstream:** Bitstream is output.

- 3** Press **▲/▼** to select the preferred value at each screen and press **SELECT**.

The screen at the step 1 is displayed. Press **▼** to select “0” and press **SELECT** to return to the initial settings screen.

Also refer to “Common procedures of initial settings” on page 31.

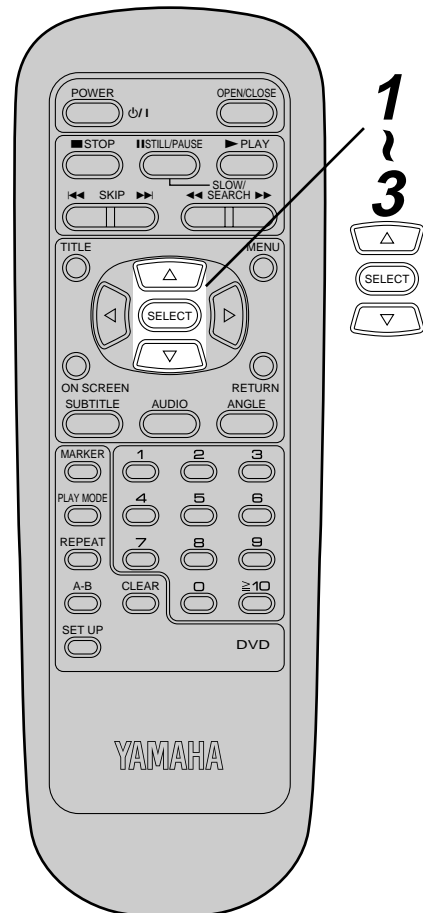

## Initial settings

---

### For your reference:

● Make settings as shown in the table **A** depending on the kind of amplifier that is connected to the optical/coaxial digital audio output connector.

\* Audio output from the unit's audio output connectors is converted to 48 kHz/16 bit in addition to audio from the digital audio output connector.

To enjoy high quality sound at 48 kHz/20 bit/24 bit or 96 kHz, connect the amplifier or decoder directly to the audio output connectors, not to the digital audio output connector. [Select "Off" at the "1 LPCM (DVD)".]

**A**

Type of amplifier to be connected	Recommendable setting		
	LPCM (DVD)	Dolby Digital	MPEG
No amplifier is connected	Off	Bitstream	PCM
AV amplifier including Dolby Digital decoder	PCM*	Bitstream	PCM
AV amplifier including Dolby Digital/MPEG audio decoder	PCM*	Bitstream	Bitstream

## Initial settings

### Speaker setting

- At the initial settings screen  
Press **▲/▼** to select **“8 Speaker Setting”** and press **SELECT**.

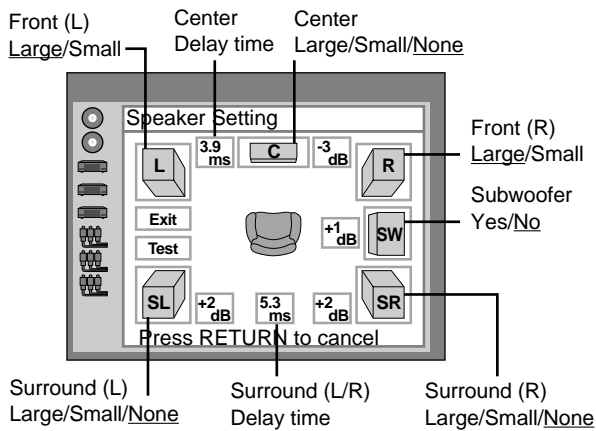

- Press **◀/▶/▲/▼** to select the preferred item and press **SELECT**.

- Press **◀/▶/▲/▼** to select the preferred value and press **SELECT**.

#### Speaker icons

- If the speaker is connected, display the icon. Clear the icon if the speaker is not connected.
- If the speaker supports low-frequency (under 100 Hz) reproduction, select the larger icon. If the speaker's low-frequency (under 100 Hz) reproduction ability is poor, select the smaller icon. [When the subwoofer is not connected, be sure to select “Large” for the front speakers (L/R).]

#### Delay time:

If the surround speakers or the center speaker can't be installed at an equal distance to (or further away) the front speakers from the listening position, change the delay time to get better surround effect.

- When D2 or D3 is equal to or larger than D1, no setting is necessary (**B**). Otherwise, change the setting according to the table below.

Speaker	Delay time	Difference between D1 and D2/D3
Center speaker (D2)	1.3 ms	approx. 50 cm
	2.6 ms	approx. 100 cm
	3.9 ms	approx. 150 cm
	5.3 ms	approx. 200 cm
Surround speakers (D3)	5.3 ms	approx. 200 cm
	10.6 ms	approx. 400 cm
	15.9 ms	approx. 600 cm

#### Channel balance:

While listening to the test signal, adjust the volume of the center, surround (L), surround (R) speakers and the subwoofer so that the volume is equal to that of the front speakers.

**A**

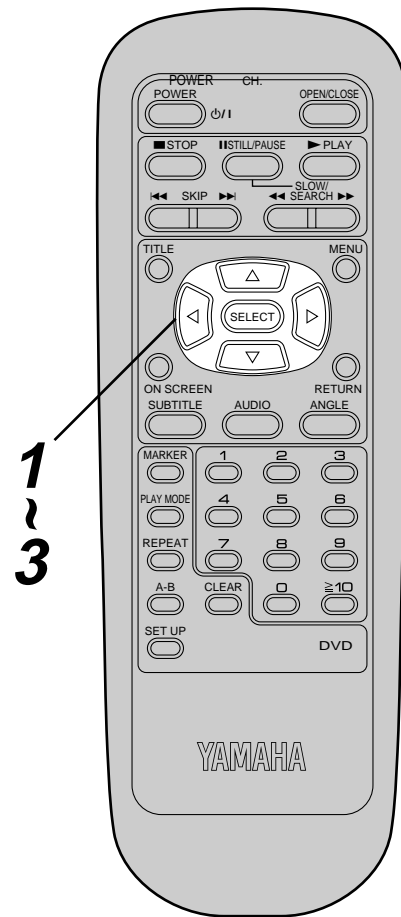

1  
2  
3

**B**

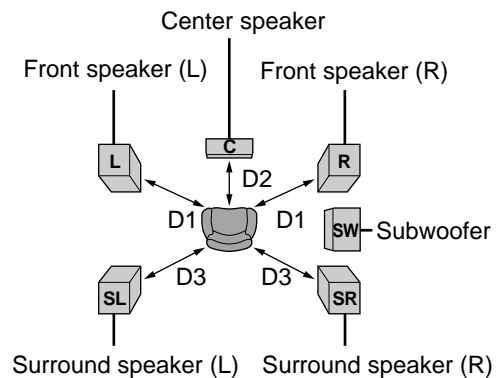

## Initial settings

### 4 Press ◀/▶/▲/▼ to select “Exit” and press SELECT.

Setting is finished and the initial settings screen is displayed.

#### Note:

- The “Large/Small” setting has no effect on DVDs recorded in MPEG 2 audio.

#### For your reference:

##### •To output the test signal

1. Press ◀/▶/▲/▼ to select “Test”, and then press SELECT.  
(Test signals will be output consecutively from each speaker clockwise.)
2. Press ◀/▶/▲/▼ to select the appropriate volume (−6 dB through +6 dB) while the test signal is being output from the speaker.
3. Press SELECT. (The test signals are stopped.)

Also refer to “Common procedures of initial settings” on page 31.

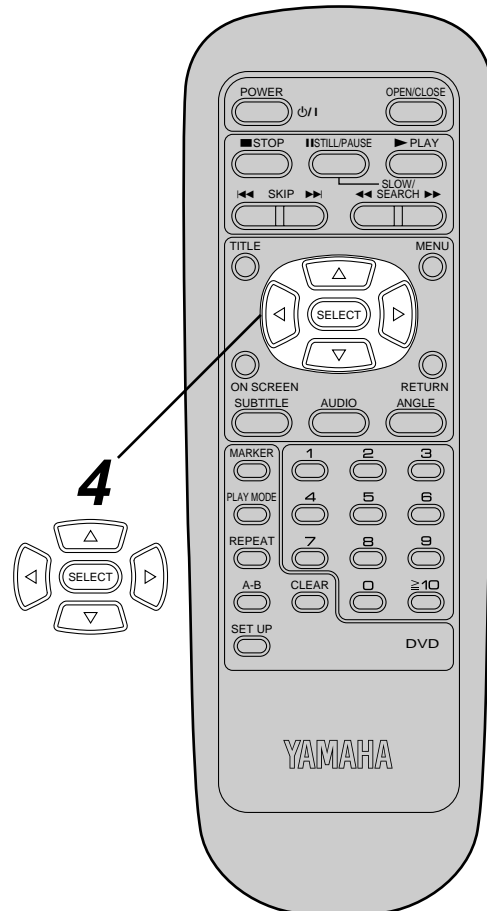



## Initial settings

### Other settings

- 1 At the initial settings screen  
Press ▲/▼ to select “9 Other Settings” and  
press SELECT.

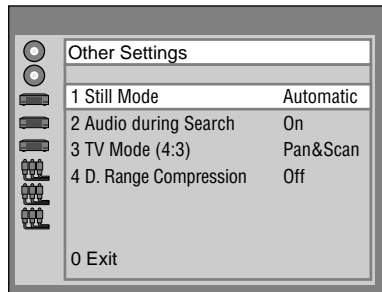

- 2 Press ▲/▼ to select the preferred item  
(1–4) and press SELECT.

#### When “1 Still Mode” is selected

**Automatic:** “Frame still” and “Field still” are automatically selected during the still mode.  
(Factory setting)

**Field:** Select this setting when jittering occurs in the pictures even when “Automatic” is selected.

#### When “2 Audio during Search” is selected

**On:** Factory setting (When noises during search are disagreeable, select “Off”.)

**Off:** Select this setting if audio during search is not necessary.

#### When “3 TV Mode (4:3)” is selected

**Pan & Scan:** The video material for a wide-screen will be played back in the Pan & Scan style on a conventional size TV.  
(Factory setting)

- Video material not formatted in the Pan & Scan style will be played back in the letterbox style. (See page 36.)

**Letterbox:** Select this setting to play back the video material for a wide-screen in the letterbox style on a conventional size TV.

#### When “4 D. (Dynamic) Range Compression” is selected

**Off:** Normal audio range is selected. (Factory setting)

**On:** Select this setting to enjoy listening to dynamic sound even on a low volume. This is useful for late-night listening. [This function only works with Dolby Digital (AC-3) DVDs.]

- 3 Press ▲/▼ to select the preferred value at  
each screen and press SELECT.

The screen at the step 1 is displayed. Press ▲/▼ to select “0” and press SELECT to return to the initial settings screen.

Also refer to “Common procedures of initial settings” on page 31.

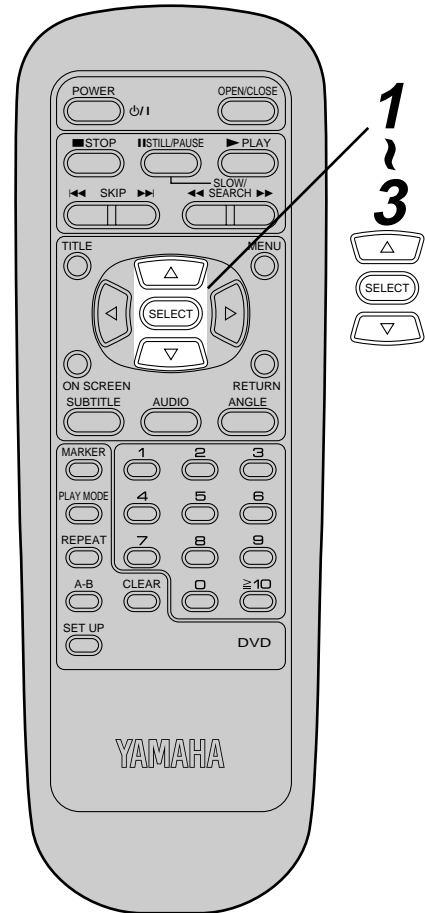

## Disc handling and maintenance

### Handling precautions

- Hold the disc by the edges so the surface will not be soiled with fingerprints. **(A)**  
Fingerprints, dirt and scratches can cause skipping and distortion.
- Do not write on the label side with a ball-point pen or other writing utensils.
- Do not use record cleaning sprays, benzine, thinner, static electricity prevention liquids or any other solvent.
- Be careful not to drop or bend the disc.
- Do not install more than 1 disc on the disc tray.
- Do not try to close the disc tray when the disc is not installed properly. **(B)**
- Be sure to store the disc in its exclusive case when not in use.

### If the surface is soiled **(C)**

Wipe gently with a soft, damp (water only) cloth.

When wiping discs, always move the cloth from the center hole toward the outer edge.

(If you wipe the discs using a circular motion, circular scratches are likely to occur, which will cause noise.)

### If the disc is brought from a cold to a warm environment, moisture may form on the disc

Wipe this moisture off with a soft, dry, lint-free cloth before using the disc.

### Improper disc storage

You can damage discs if you store them in the following places:

- Areas exposed to direct sunlight
- Humid or dusty areas
- Areas directly exposed to a heat outlet or heating appliance

### Discs which cannot be played with this player For Continental Europe and United Kingdom models

- DVD with Region No. other than "2" or "ALL"

#### For Australia model

- DVD with Region No. other than "4" or "ALL"

#### For other models

- DVD with Region No. other than "3" or "ALL"

- DVD-ROM
- DVD-R/DVD-RAM
- CD-ROM
- CDV
- CD-G

- **Do not try to play Photo CD or CD-R.**

### To prevent a malfunction of this unit

- Do not use any non standard shaped CD (heart etc.) available on the market, because it may damage the unit.
- Do not use a CD with tape, seals, or paste on it, because damage to the unit may result.

## Maintenance

- Be sure to switch the power to the standby mode and disconnect the AC mains lead before maintaining the unit.
- Wipe this unit with a dry soft cloth.  
If the surfaces are extremely dirty, wipe clean with a cloth which has been dipped in a weak soap-and-water solution and wrung out thoroughly, and then wipe again with a dry cloth.
- Never use alcohol, benzine, thinner, cleaning fluid or other chemicals. And do not use compressed air to remove dust.

**A**

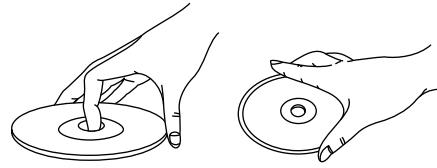

**B**

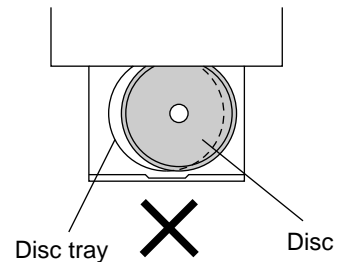

**C**

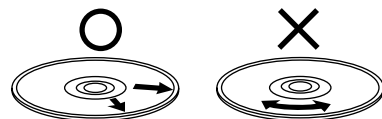

## Language code list

Enter the appropriate code number for the initial settings “Audio”, “Subtitle” and/or “Menus” (see page 32).

Code	Language Name	Code	Language Name	Code	Language Name	Code	Language Name
6565	Afar	7079	Faroese	7678	Lingala	8375	Slovak
6566	Abkhazian	7082	French	7679	Laothian	8376	Slovenian
6570	Afrikaans	7089	Frisian	7684	Lithuanian	8377	Samoan
6577	Ameharic	7165	Irish	7686	Latvian, Lettish	8378	Shona
6582	Arabic	7168	Scots Gaelic	7771	Malagasy	8379	Somali
6583	Assamese	7176	Galician	7773	Maori	8381	Albanian
6588	Aymara	7178	Guarani	7775	Macedonian	8382	Serbian
6590	Azerbaijani	7185	Gujarati	7776	Malayalam	8385	Sundanese
6665	Bashkir	7265	Hausa	7778	Mongolian	8386	Swedish
6669	Byelorussian	7273	Hindi	7779	Moldavian	8387	Swahili
6671	Bulgarian	7282	Croatian	7782	Marathi	8465	Tamil
6672	Bihari	7285	Hungarian	7783	Malay	8469	Telugu
6678	Bengali; Bangla	7289	Armenian	7784	Maltese	8471	Tajik
6679	Tibetan	7365	Interlingua	7789	Burmese	8472	Thai
6682	Breton	7378	Indonesian	7865	Nauru	8473	Tigrinya
6765	Catalan	7383	Icelandic	7869	Nepali	8475	Turkmen
6779	Corsican	7384	Italian	7876	Dutch	8476	Tagalog
6783	Czech	7387	Hebrew	7879	Norwegian	8479	Tonga
6789	Welsh	7465	Japanese	7982	Oriya	8482	Turkish
6865	Danish	7473	Yiddish	8065	Panjabi	8484	Tatar
6869	German	7487	Javanese	8076	Polish	8487	Twi
6890	Bhutani	7565	Georgian	8083	Pashto, Pushto	8575	Ukrainian
6976	Greek	7575	Kazakh	8084	Portuguese	8582	Urdu
6978	English	7576	Greenlandic	8185	Quechua	8590	Uzbek
6979	Esperanto	7577	Cambodian	8277	Rhaeto-Romance	8673	Vietnamese
6983	Spanish	7578	Kannada	8279	Romanian	8679	Volapük
6984	Estonian	7579	Korean	8285	Russian	8779	Wolof
6985	Basque	7583	Kashmiri	8365	Sanskrit	8872	Xhosa
7065	Persian	7585	Kurdish	8368	Sindhi	8979	Yoruba
7073	Finnish	7589	Kirghiz	8372	Serbo-Croatian	9072	Chinese
7074	Fiji	7665	Latin	8373	Singhalese	9085	Zulu

# Troubleshooting

If the unit fails to operate normally, check the following points to determine whether the fault can be corrected by the simple measures suggested. If it cannot be corrected, or if the fault is not listed in the SYMPTOM column, disconnect the power cord and contact your authorized YAMAHA dealer or service center for help.

Symptom (Common)	Remedy
No power.	Insert the AC mains lead securely into the power outlet.
Power is automatically switched to the standby mode.	The power is automatically switched to the standby mode after approx. 30 minutes have elapsed in the stop mode (auto turn-off function). Turn the power back on.
<ul style="list-style-type: none"> <li>● Play fails to start even when PLAY is pressed.</li> <li>● Play commences but then stops immediately.</li> </ul>	<ul style="list-style-type: none"> <li>● Condensation has formed: wait about 1 to 2 hours to allow the player to dry out.</li> <li>● This player cannot play discs other than DVDs, Video CDs and CDs.</li> <li>● The disc may be dirty and may require cleaning.</li> <li>● Ensure that the disc is installed with the label side up.</li> </ul>
No picture.	<ul style="list-style-type: none"> <li>● Ensure that the equipment is connected properly.</li> <li>● Ensure that the input setting for the TV is an Audio/Video (AV) position, e.g. AV1, AV2.</li> </ul>
<ul style="list-style-type: none"> <li>● No sound.</li> <li>● Distorted sound.</li> </ul>	<ul style="list-style-type: none"> <li>● Ensure that the equipment is connected properly.</li> <li>● Ensure that the input settings for the TV and stereo system are proper.</li> </ul>
Picture is distorted during rapid advance or rapid reverse.	The picture will be somewhat distorted at times: this is normal.
No rapid advance (or rapid reverse) play.	Some discs may have sections which prohibit rapid advance (or rapid reverse).
No 4:3 (16:9) picture.	Choose the correct setup "TV Aspect" item which matches the TV set used.
No on-screen display.	The "Off" setting is selected for "On-Screen Messages": select "On".
No surround sound.	Choose the correct setup at the "Speaker setting" which matches your stereo system.
No operations can be performed with the remote control.	<ul style="list-style-type: none"> <li>● Check the batteries are installed with the correct polarities (+ and -).</li> <li>● The batteries are depleted: replace them with new ones.</li> <li>● Point the remote control unit at the remote control sensor and operate.</li> <li>● Operate the remote control unit at a distance of not more than 7 meters from the remote control sensor.</li> <li>● Remove the obstacles between the remote control unit and remote control sensor.</li> </ul>
No key operation (by the unit and/or the remote control) is effective.	Switch the power to the standby mode and then return to ON. Alternatively, switch the power to the standby mode, disconnect the AC mains lead and then re-connect it. (The player may not be operating properly due to lightning, static electricity or some other external factor.)
GUI Screen not displayed or only partially displayed on the TV Screen.	Select the appropriate TV screen type by consulting the operation manual of the TV.

Symptom [DVD]	Remedy
Play does not commence even when title is selected.	Confirm the "Ratings" setting.

Symptom [DVD]	Remedy
Audio soundtrack and/or subtitle language is not the one selected at the initial settings.	If the audio soundtrack and/or subtitle language does not exist on the disc, the language selected at the initial settings will not be seen/heard.
The menu is displayed in French (example).	The setup "Menus" of "Disc Languages" is set to French: select English.
Lightening and darkening of the picture.	Some discs will be copy protected at the direction of copyright owners. During playback of those discs, picture may not be normally played back when video signals containing a copy protected signal are played back through a VCR. It is recommended to connect the DVD/Video CD/CD player directly to an AV amplifier or to a TV set, not through a VCR.
No subtitles.	<ul style="list-style-type: none"> <li>• Subtitles appear only with discs which contain them.</li> <li>• Subtitles are cleared from the TV monitor. Perform the steps on page 27 to display the subtitles.</li> </ul>
Alternative audio soundtrack (or subtitle) languages fail to be selected.	<ul style="list-style-type: none"> <li>• An alternative language is not selected with discs which do not contain more than one language.</li> <li>• In the case of some discs, the alternative language cannot be selected by operating the AUDIO or SUBTITLE button. Try selecting it from the DVD menu if one is available.</li> </ul>
Angle cannot be changed.	This function is dependent on software availability. Even if a disc has a number of angles recorded, these angles may be recorded for specific scenes only (when "ANGLE" lights up on the FL display.)
The password for age restriction has been forgotten.	While the unit is in the stop mode, hold the unit's ◀◀ SKIP button and the STILL/ PAUSE button down simultaneously and then hold the POWER button down for longer than 3 seconds (until "Initialized" disappears from the TV monitor). The lock will be released and all initial settings will return to the default values.

Symptom [Video CD]	Remedy
No menu play.	This function works only for Video CDs with playback control.

## Self-diagnosis display function

When an error or trouble is detected during operation, a service number appears in the display window. When a service number has appeared, check out the details given below.

Service number	Player status	Remedy
U11	Disc is dirty.	Wipe the disc clean.
H □ □	Trouble is likely to have occurred. The number following "H" differs depending on the status of the player.	Switch the power to the standby mode and then return to ON. Alternatively, switch the power to the standby mode, disconnect the AC mains lead and then re-connect it. If the service number fails to be cleared even when the remedial action is taken, ask for the service engineer to repair the player.

## Definition of terms

---

### Angle

Recorded onto some DVD discs are scenes which have been simultaneously shot from a number of different angles (the same scene is shot from the front, from the left side, from the right side, etc.). With such discs, the ANGLE button can be used to view the scene from different angles.

### Chapter number

These numbers are recorded on DVD discs. A title is subdivided into many sections, each of which is numbered, and specific parts of video presentations can be searched quickly using these numbers.

### DVD

This refers to a high-density optical disc on which high-quality pictures and sound have been recorded by means of digital signals. Incorporating a new video compression technology (MPEG II) and high-density recording technology, DVD enables esthetically pleasing full-motion video to be recorded over long periods of time (for instance, a whole movie can be recorded).

DVD has a structure consisting of two 0.6 mm thin discs which are adhered to each other. Since the thinner the disc, the higher the density at which the information can be recorded, a DVD disc has a greater capacity than a single 1.2 mm thick disc. Since the two thin discs are adhered to each other, there is the potential to achieve double-sided play sometime in the future for even longer duration play.

### Playback control

This is recorded on a Video CD (version 2.0). The scenes or information to be viewed (or listened to) can be selected interactively with the TV monitor by looking at the menu shown on the TV monitor.

### Subtitles

These are the printed lines appearing at the bottom of the screen which translate or transcribe the dialogue. They are recorded on DVD discs.

### Time number

This indicates the play time which has elapsed from the start of a disc or a title. It can be used to find a specific scene quickly. (It may not work with some discs.)

### Title number

These numbers are recorded on DVD discs. When a disc contains two or more movies, these movies are numbered as title 1, title 2, etc.

### Track number

These numbers are assigned to the tracks which are recorded on Video CDs and CDs. They enable specific tracks to be located quickly.

### Video CD

This contains recordings of pictures and sound whose quality is on a par with that of videotape. This player also supports Video CDs with playback control (version 2.0).

# Specifications

**Power requirements:** **For Continental Europe, United Kingdom and Australia models**  
AC 220–240 V, 50 Hz  
**For other models**  
AC 110–240 V, 50/60 Hz

**Power consumption:** 22 W (approx. 4 W when set to standby mode by the STANDBY/ON button or the remote control)

**Signal system:** **For Continental Europe, United Kingdom and Australia models**  
PAL 625/50, PAL 525/60  
**For other models**  
NTSC/PAL

**Weight:** 3.6 kg

**Dimensions:** 435 (W)×284 (D)×87.5 (H) mm  
(excluding protrusions)

**Operating temperature range:**  
+5 to +35°C

**Operating humidity range:**  
5 to 90% (no condensation)

**Discs played:**

**(1) DVD-VIDEO disc**

- 12 cm single-sided, single-layer
- 12 cm single-sided, double-layer
- 12 cm double-sided, double-layer (one layer per side)
- 8 cm single-sided, single-layer
- 8 cm single-sided, double-layer
- 8 cm double-sided, double-layer (one layer per side)

**(2) Compact disc (CD-DA, VIDEO CD)**

- 12 cm disc
- 8 cm disc

**S-video output:**

- Y output level: 1 Vp-p (75Ω)
- C output level: 0.300 Vp-p (75Ω)
- Output connector: S terminal (1 system)

**Video output:**

- Output level: 1 Vp-p (75Ω)
- Output connector: Pin jack (2 systems)

**Audio output:**

- Output level: 2 Vrms (1 kHz, 0 dB)
- Output connector: Pin jack
- 5.1ch mixed output: 1 system (2ch)
- 5.1ch discrete output: 1 system (5.1ch)

**Audio signal output characteristics:**

- (1) Frequency response:
  - DVD (linear audio):  
2 Hz–22 kHz (48 kHz sampling)
  - 2 Hz–44 kHz (96 kHz sampling)
  - CD audio: 2 Hz–20 kHz (EIAJ)
- (2) S/N ratio:
  - CD audio: 115 dB (EIAJ)
- (3) Dynamic range:
  - DVD (linear audio): 102 dB
  - CD audio: 99 dB (EIAJ)
- (4) Total harmonic distortion:
  - CD audio: 0.0025% (EIAJ)

**Digital audio output:**

- Optical digital output: Optical connector
- Coaxial digital output: pin jack

**Pickup:** Wave length: 655 nm  
Laser power: CLASS 2

Specifications are subject to change without notice.  
Weight and dimensions are approximate.

## Region Management Information

Region Management Information: This DVD/VIDEO CD/CD player is designed and manufactured to respond to the Region Management Information that is recorded on a DVD disc. If the Region number described on the DVD disc does not correspond to the Region number of this DVD/VIDEO CD/CD player, this DVD/VIDEO CD/CD player cannot play this disc.

### For Continental Europe and United Kingdom models

The Region number for this DVD/VIDEO CD/CD player is 2.

### For Australia model

The Region number for this DVD/VIDEO CD/CD player is 4.

### For other models

The Region number for this DVD/VIDEO CD/CD player is 3.



This product incorporates copyright protection technology that is protected by method claims of certain U.S. patents and other intellectual property rights owned by Macrovision Corporation and other rights owners. Use of this copyright protection technology must be authorized by Macrovision Corporation, and is intended for home and other limited viewing uses only unless otherwise authorized by Macrovision Corporation. Reverse engineering or disassembly is prohibited.

# YAMAHA

**YAMAHA ELECTRONICS CORPORATION, USA** 6660 ORANGETHORPE AVE., BUENA PARK, CALIF. 90620, U.S.A.

**YAMAHA CANADA MUSIC LTD.** 135 MILNER AVE., SCARBOROUGH, ONTARIO M1S 3R1, CANADA

**YAMAHA ELECTRONIK EUROPA G.m.b.H.** SIEMENSSTR. 22-34, 25462 RELLINGEN BEI HAMBURG, F.R. OF GERMANY

**YAMAHA ELECTRONIQUE FRANCE S.A.** PA PARIS-EST RUE AMBROISE CROIZAT CROISSY-BEAUBOURG BP70-77312 MARNE LAVALLEE, CEDEX 2 FRANCE

**YAMAHA ELECTRONICS (UK) LTD.** YAMAHA HOUSE, 200 RICKMANSWORTH ROAD WATFORD, HERTS WD1 7JS, ENGLAND

**YAMAHA SCANDINAVIA A.B.** J A WETTERGRENS GATA 1, BOX 30053, 400 43 VÄSTRA FRÖLUNDA, SWEDEN

**YAMAHA MUSIC AUSTRALIA PTY, LTD.** 17-33 MARKET ST., SOUTH MELBOURNE, 3205 VIC., AUSTRALIA

**YAMAHA CORPORATION**

 VQT7523-1 Printed in Japan