



# CDX-593/493/393MKII

*Compact Disc Player*

*Lecteur Compact Disque*

*Thank you for selecting this YAMAHA Compact Disc Player.  
Nous vous remercions d'avoir porté votre choix sur ce lecteur  
de disque audionumérique YAMAHA.*



## OWNER'S MANUAL

### FEATURES

- Random Access Programmable Play
- Random-Sequence Play
- Single Track/Entire Disc Repeat Play
- Automatic Spacing Capability
- Automatic Programming for Recording to Tape
- Automatic Peak Level Searching Capability
- CD Synchronized Recording with a Compatible YAMAHA Tape Deck
- Adjustable Display Brightness
- Remote Control Capability
- **CDX-593**  
Optical and Coaxial Digital Outputs
- **CDX-493 and 393MKII**  
Optical Digital Output

### CONTENTS

Safety Instructions .....	2
Connections .....	4
Identification of Components .....	6
Basic Operation .....	8
Random-Sequence Play .....	12
Repeat Play .....	12
Program Play .....	13
Index Search .....	14
Track Programming for Recording to Tape .....	15
CD Synchronized Recording .....	19
Notes about the Remote Control	
Transmitter .....	20
Notes about Handling Compact Discs .....	20
Troubleshooting .....	21
Specifications .....	22

## MODE D'EMPLOI

### CARACTERISTIQUES

- Lecture programmable à accès aléatoire
- Lecture en séquence aléatoire
- Lecture répétée de plage unique/disque entier
- Fonction d'espacement automatique
- Programmation automatique de pour l'enregistrement sur bande
- Fonction de recherche automatique du niveau de crête
- Enregistrement synchronisé de CD avec un magnétophone à cassette compatible YAMAHA
- Fonction de modification de luminosité de l'affichage
- Fonctionnement par télécommande
- **CDX-593**  
Sorties numérique optique et sortie numérique coaxiale
- **CDX-493 et 393MKII**  
Sortie numérique optique

### TABLE DES MATIERES

Attention .....	3
Connexions .....	4
Identification des composants .....	6
Fonctionnement de base .....	8
Lecture en séquence aléatoire .....	12
Lecture répétée .....	12
Lecture programmée .....	13
Recherche d'index .....	14
Programmation des plages pour enregistrement sur bande .....	15
Enregistrement synchronisé d'un CD .....	19
Remarques concernant la télécommande .....	20
Remarques concernant la manipulation des disques compacts .....	20
Dépistage de pannes .....	21
Caractéristiques techniques .....	22

# SAFETY INSTRUCTIONS

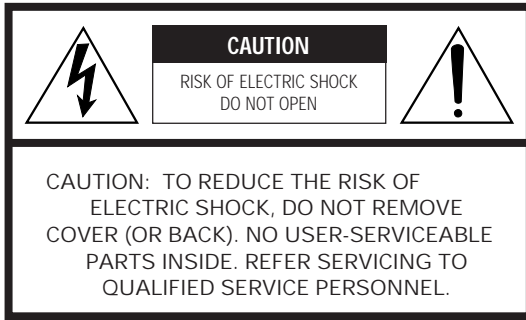

## • Explanation of Graphical Symbols

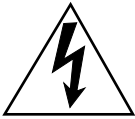

The lightning flash with arrowhead symbol, within an equilateral triangle, is intended to alert you to the presence of uninsulated "dangerous voltage" within the product's enclosure that may be of sufficient magnitude to constitute a risk of electric shock to persons.



The exclamation point within an equilateral triangle is intended to alert you to the presence of important operating and maintenance (servicing) instructions in the literature accompanying the appliance.

## WARNING

TO REDUCE THE RISK OF FIRE OR ELECTRIC SHOCK, DO NOT EXPOSE THIS UNIT TO RAIN OR MOISTURE.

- 1** Read Instructions – All the safety and operating instructions should be read before the unit is operated.
- 2** Retain Instructions – The safety and operating instructions should be retained for future reference.
- 3** Heed Warnings – All warnings on the unit and in the operating instructions should be adhered to.
- 4** Follow Instructions – All operating and other instructions should be followed.
- 5** Water and Moisture – The unit should not be used near water – for example, near a bathtub, washbowl, kitchen sink, laundry tub, in a wet basement, or near a swimming pool, etc.
- 6** Carts and Stands – The unit should be used only with a cart or stand that is recommended by the manufacturer.
- 6A** A unit and cart combination should be moved with care. Quick stops, excessive force, and uneven surfaces may cause the unit and cart combination to overturn.
- 7** Wall or Ceiling Mounting – The unit should be mounted to a wall or ceiling only as recommended by the manufacturer.
- 8** Ventilation – The unit should be situated so that its location or position does not interfere with its proper ventilation. For example, the unit should not be situated on a bed, sofa, rug, or similar surface, that may block the ventilation openings; or placed in a built-in installation, such as a bookcase or cabinet that may impede the flow of air through the ventilation openings.
- 9** Heat – The unit should be situated away from heat sources such as radiators, stoves, or other appliances that produce heat.



- 10** Power Sources – The unit should be connected to a power supply only of the type described in the operating instructions or as marked on the unit.
- 11** Power-Cord Protection – Power-supply cords should be routed so that they are not likely to be walked on or pinched by items placed upon or against them, paying particular attention to cords at plugs, convenience receptacles, and the point where they exit from the unit.
- 12** Cleaning – The unit should be cleaned only as recommended by the manufacturer.
- 13** Nonuse Periods – The power cord of the unit should be unplugged from the outlet when left unused for a long period of time.
- 14** Object and Liquid Entry – Care should be taken so that objects do not fall into and liquids are not spilled into the inside of the unit.
- 15** Damage Requiring Service – The unit should be serviced by qualified service personnel when:
  - A.** The power-supply cord or the plug has been damaged; or
  - B.** Objects have fallen, or liquid has been spilled into the unit; or
  - C.** The unit has been exposed to rain; or
  - D.** The unit does not appear to operate normally or exhibits a marked change in performance; or
  - E.** The unit has been dropped, or the cabinet damaged.
- 16** Servicing – The user should not attempt to service the unit beyond those means described in the operating instructions. All other servicing should be referred to qualified service personnel.
- 17** Power Lines – An outdoor antenna should be located away from power lines.
- 18** Grounding or Polarization – Precautions should be taken so that the grounding or polarization is not defeated.

## We Want You Listening For A Lifetime (for US customers only)

YAMAHA and the Electronic Industries Association's Consumer Electronics Group want you to get the most out of your equipment by playing it at a safe level. One that lets the sound come through loud and clear without annoying blaring or distortion – and, most importantly, without affecting your sensitive hearing. Since hearing damage from loud sounds is often undetectable until it is too late, YAMAHA and the Electronic Industries Association's Consumer Electronics Group recommend you to avoid prolonged exposure from excessive volume levels.



### IMPORTANT!

Please record the serial number of this unit in the space below.

Model:  
Serial No.:

The serial number is located on the rear of the unit. Retain this Owner's Manual in a safe place for future reference.

**CAUTION: READ THIS BEFORE OPERATING YOUR UNIT**

- 1** To ensure the finest performance, please read this manual carefully. Keep it in a safe place for future reference.
- 2** Install your unit in a cool, dry, clean place – away from windows, heat sources, vibration, dust, moisture, or cold. To avoid humming sounds, locate the unit away from other electrical appliances, motors, and transformers. To prevent fire or electrical shock, do not expose to rain and water.
- 3** Do not operate the unit upside-down. It may overheat, possibly causing damage.
- 4** Never open the cabinet. If a foreign object drops into the set, contact your dealer.
- 5** Do not use force on switches, knobs or cords. When moving the set, first turn the unit off. Always disconnect the cords from the AC outlet or other equipment by pulling the plug itself; never pull on the cord.
- 6** Do not clean the unit with chemical solvents; this might damage the finish. Use a clean, dry cloth.
- 7** Be sure to read the “TROUBLESHOOTING” section on common operating errors before concluding that your unit is faulty.
- 8** Do not place another component on top of this unit, as damage or discoloration on the surface of the unit may result.
- 9** To prevent damage by lightning, disconnect the power cord from the AC outlet during an electrical storm.
- 10** When disconnecting the power cord from the AC outlet, grasp the plug; do not pull the cord.
- 11 Voltage selector (General model only)**  
The voltage selector (on the rear panel of this unit) must be correctly set to the voltage used locally before making any connection to the AC power supply.

**WARNING****CAUTION**

Use of controls or adjustments or performance of procedures other than those specified herein may result in hazardous radiation exposure.

**DANGER**

Invisible laser radiation when open and interlock failed or defeated.  
Avoid direct exposure to beam.

**CAUTION (FOR CANADA MODEL)**

TO PREVENT ELECTRIC SHOCK, MATCH WIDE BLADE OF PLUG TO WIDE SLOT AND FULLY INSERT.

**FOR CANADIAN CUSTOMER**

THIS CLASS B DIGITAL APPARATUS MEETS ALL REQUIREMENTS OF THE CANADIAN INTERFERENCE-CAUSING EQUIPMENT REGULATIONS.

As the laser beam used in this compact disc player is harmful to the eyes, do not attempt to disassemble the cabinet. Refer servicing to qualified personnel only.

To avoid electrical shock, do not open the unit. Refer servicing to qualified personnel only.

**DANGER:** The use of optical instrument with this product will increase eye hazard.

**Laser Diode Properties**

- Material: GaAIAs
- Wavelength: 780 nm
- Emission Duration: continuous
- Laser Output: max. 44.6  $\mu$ W\*

\* This output is the value measured at a distance of about 200 mm from the objective lens surface on the Optical Pick-up Block.

**FCC INFORMATION (for US customers only)****1. IMPORTANT NOTICE: DO NOT MODIFY THIS UNIT!**

This product, when installed as indicated in the instructions contained in this manual, meets FCC requirements. Modifications not expressly approved by Yamaha may void your authority, granted by the FCC, to use the product.

- 2. IMPORTANT:** When connecting this product to accessories and/or another product use only high quality shielded cables. Cable/s supplied with this product **MUST** be used. Follow all installation instructions. Failure to follow instructions could void your FCC authorization to use this product in the USA.

- 3. NOTE:** This product has been tested and found to comply with the requirements listed in FCC Regulations, Part 15 for Class “B” digital devices. Compliance with these requirements provides a reasonable level of assurance that your use of this product in a residential environment will not result in harmful interference with other electronic devices.

This equipment generates/uses radio frequencies and, if not installed and used according to the instructions found in the users manual, may cause interference harmful to the operation of other electronic devices.

Compliance with FCC regulations does not guarantee that interference will not occur in all installations. If this product is found to be the source of interference, which can be determined by turning the unit “OFF” and “ON”, please try to eliminate the problem by using one of the following measures:

Relocate either this product or the device that is being affected by the interference.

Utilize power outlets that are on different branch (circuit breaker or fuse) circuits or install AC line filter/s.

In the case of radio or TV interference, relocate/reorient the antenna. If the antenna lead-in is 300 ohm ribbon lead, change the lead-in to coaxial type cable.

If these corrective measures do not produce satisfactory results, please contact the local retailer authorized to distribute this type of product. If you can not locate the appropriate retailer, please contact Yamaha Electronics Corp., U.S.A. 6660 Orangethorpe Ave, Buena Park, CA 90620.

The above statements apply **ONLY** to those products distributed by Yamaha Corporation of America or its subsidiaries.

# CONNECTIONS

- Before making any connections, switch OFF the power to the unit and the amplifier or other components.
- Connections should be made to the correct input terminals of the amplifier or other components.
- If the placement of this unit creates interference (noise) in other equipment, such as a tuner, relocate this unit away from the affected equipment.

## CDX-593

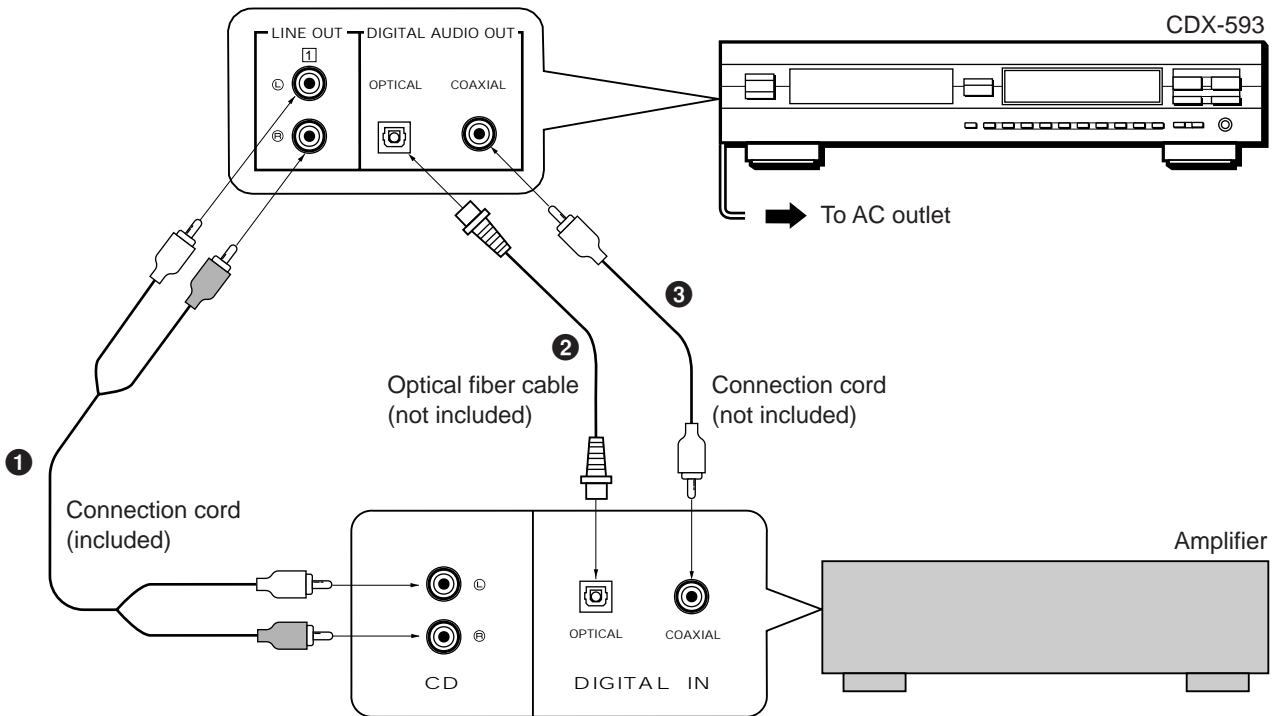

## CDX-493

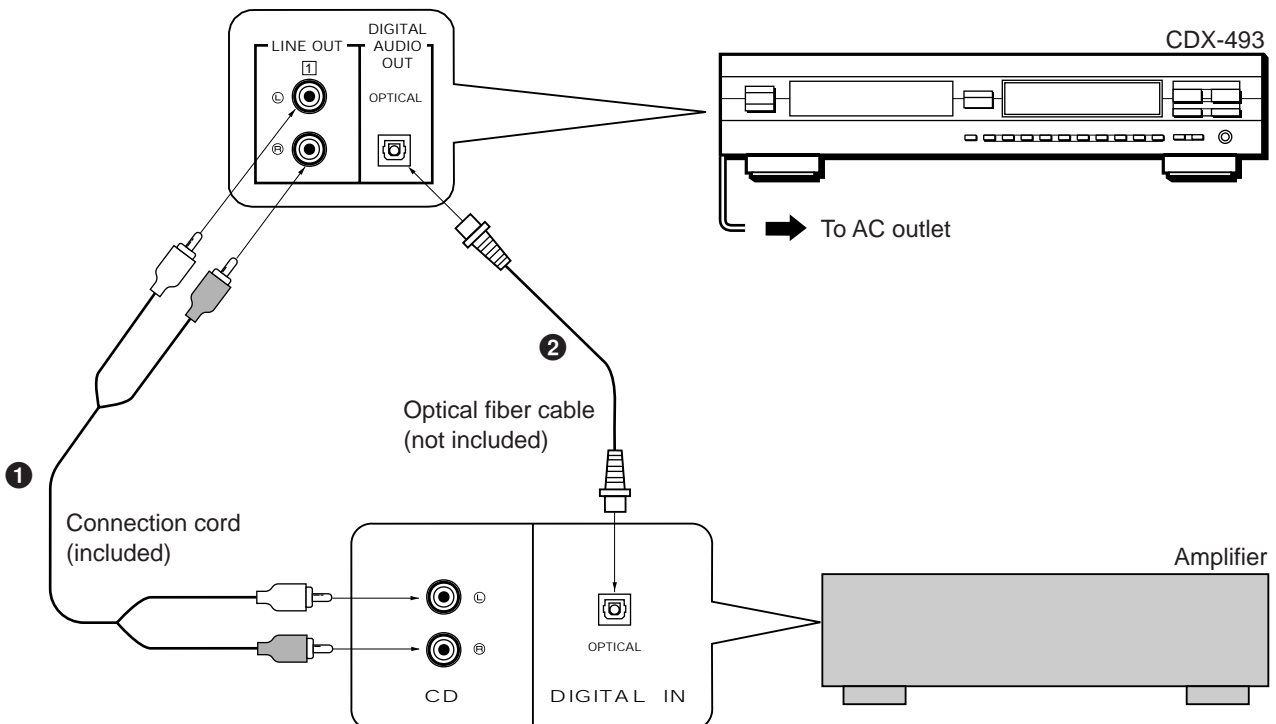

## CDX-393MKII

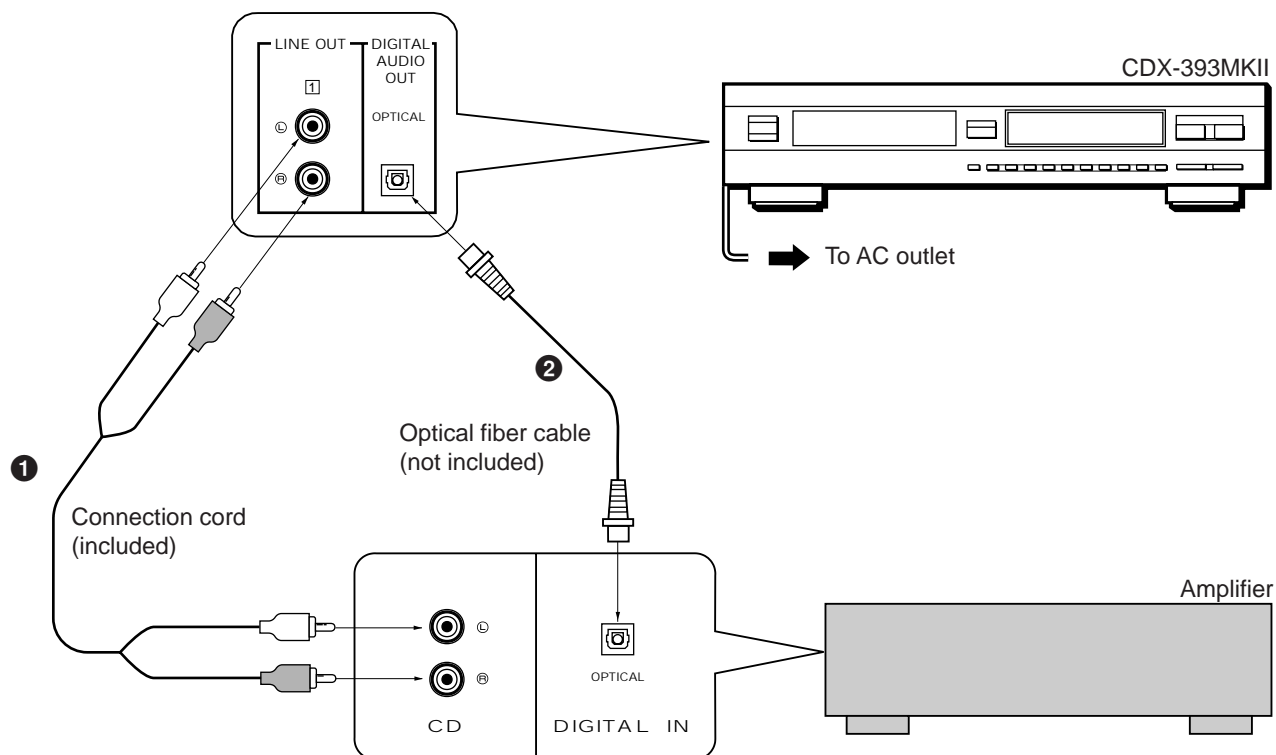

To connect this unit to your amplifier, choose one of the following procedures:

### 1 When the LINE OUT (analog) terminals of this unit are used

- Be sure that the left ("L") and right ("R") LINE OUT terminals are connected to the corresponding (left and right) terminals of the amplifier or other component.
- Connect the "LINE OUT" terminals to the "CD" (or "AUX") terminals of the amplifier. If the amplifier does not have such terminals, use the "TAPE PB" terminals. For additional details concerning these connections, refer to the operation instructions for the amplifier being used.
- The LINE OUT terminals of this unit are numbered 1. When connecting this unit with a YAMAHA amplifier or receiver whose terminals on the rear panel are numbered as 1, 2, 3, etc., connect the LINE OUT terminals of this unit to the input terminals numbered 1 on the rear of the amplifier or receiver.

### 2 When the DIGITAL OUT (OPTICAL) terminal of this unit is used

- Before using this terminal, remove the terminal's cover.
- Make the connection from this terminal to the optical input terminal of an amplifier by using a commercially available optical fiber cable.
  - \* Use an optical fiber cable that conforms to EIAJ standards. Other cables might not function correctly.
- Be sure to replace the terminal's cover when this terminal is not being used, in order to protect the terminal from dust.
- This terminal can also be connected to the optical input terminal of a digital audio tape deck (DAT) etc. to record CD onto a tape directly.

#### CDX-593 and CDX-493

- The signal output level to an amplifier can be adjusted by using the **OUTPUT LEVEL** button.

### 3 CDX-593

#### When the DIGITAL OUT (COAXIAL) terminal of this unit is used

- Make the connection from this terminal to the digital input terminal of an amplifier by using a connection cord.
- The signal output level to an amplifier can be adjusted by using the **OUTPUT LEVEL** button.

# IDENTIFICATION OF COMPONENTS

( ) indicates the page number on which the control part is best described.

## FRONT PANEL

- The control functions on the main unit and on the remote control transmitter are virtually identical, with the exceptions below.
- **▷/□□ (PLAY/PAUSE)** button on the main unit has both the functions of the **PLAY** button and the **PAUSE** button on the remote control transmitter.
- The **SKIP/SEARCH** button on the main unit has both the functions of the **SKIP** button and the **SEARCH** button on the remote control transmitter.

### CDX-593, CDX-493

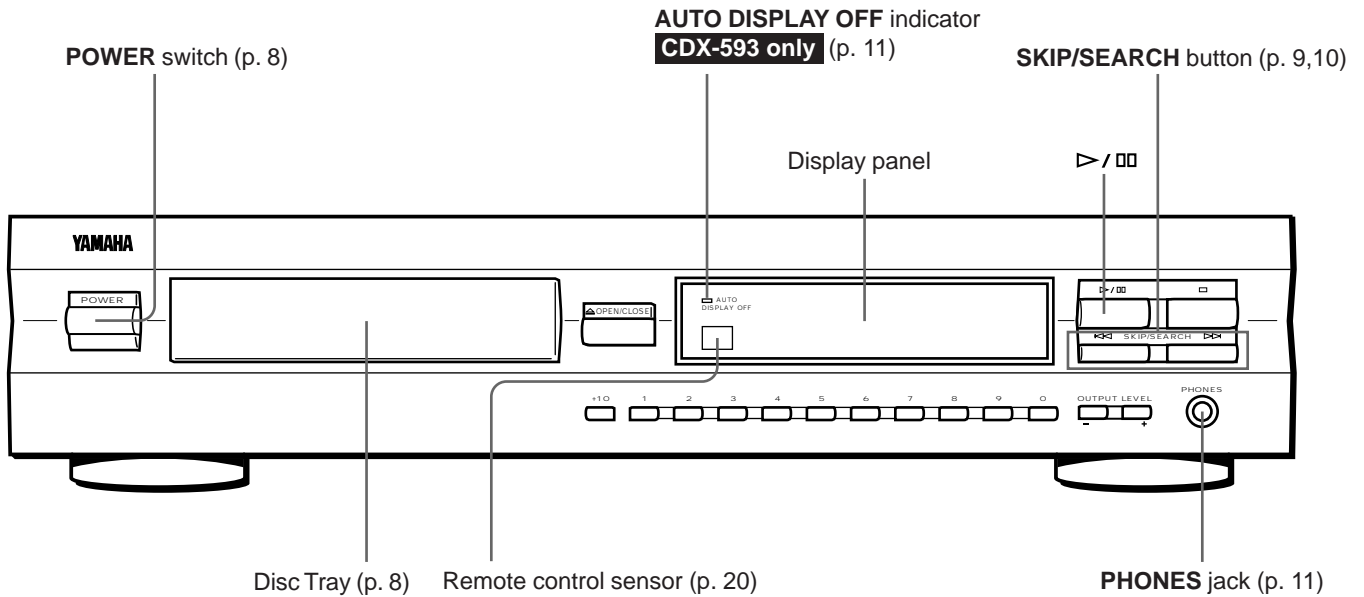

### CDX-393MKII

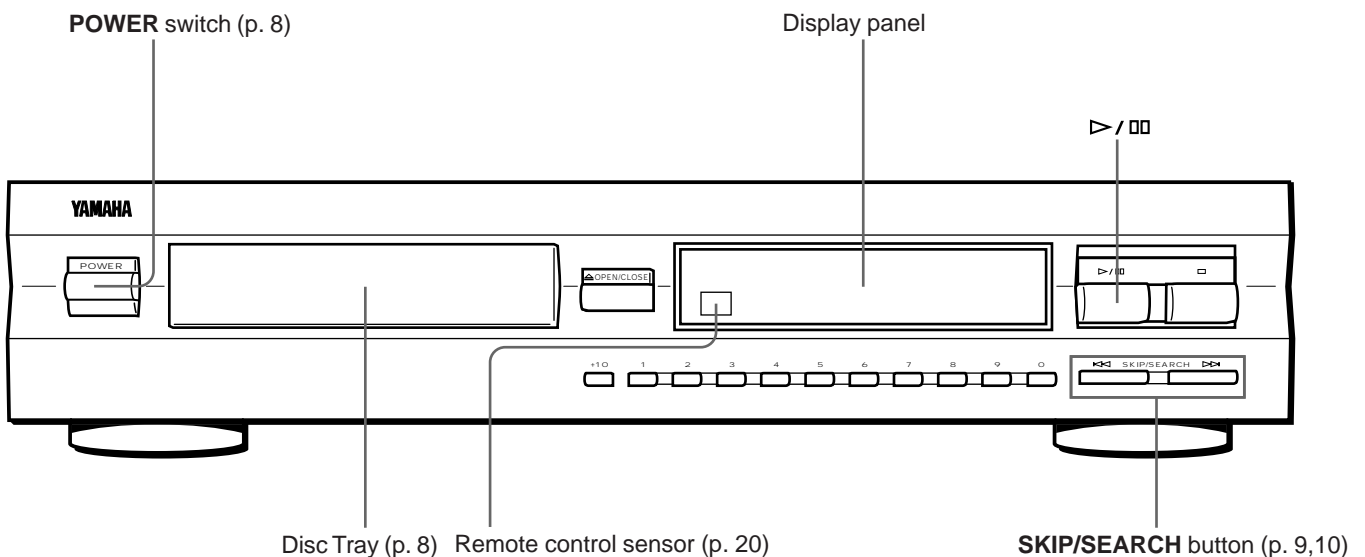

# REMOTE CONTROL TRANSMITTER

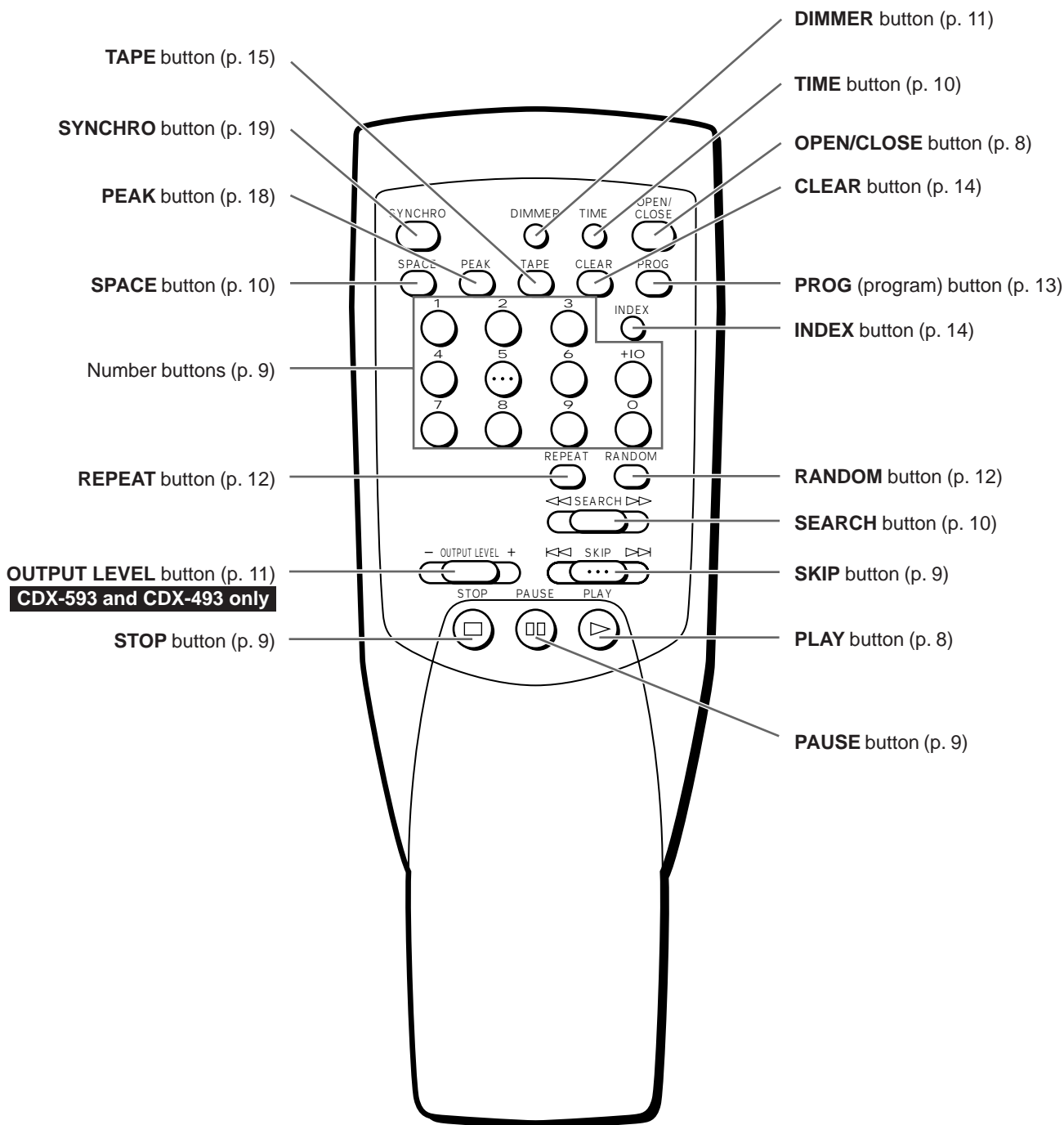

\* The CDX-593 is used for illustration purposes in this manual. Any difference in the operation of other models is clearly indicated in this instruction (for example, "CDX-593 only").  
 This manual describes how to operate this unit by using the remote control transmitter. To operate this unit from the front panel, use the corresponding buttons on the front panel.

# BASIC OPERATION

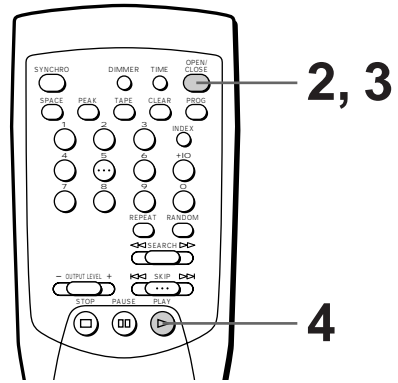
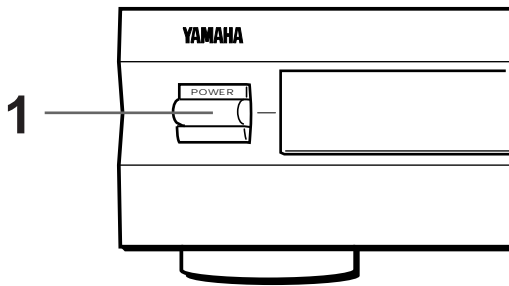

**1** Turn the power on.

**2** Load a disc.

**3** Close the disc tray.

**4**

Play will begin from the first track of the disc.

## Display information during disc play

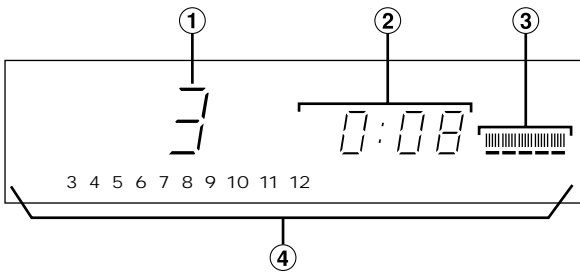

- ① Shows the track number selected or being played.
- ② Shows the time displays. (Refer to "Selecting time displays" on page 10.)
- ③ **CDX-593 and CDX-493**  
Shows the signal output level to an amplifier or the headphones, adjusted by using the **OUTPUT LEVEL** button.
- ④ Displays the CD track numbers (up to 20). After each track is played, its corresponding number disappears so that remaining track numbers can be seen at a glance.

## Notes

- After closing the disc tray by pressing the **OPEN/CLOSE** button, the display shows the total number of tracks and the total recorded time of the disc for a few seconds.

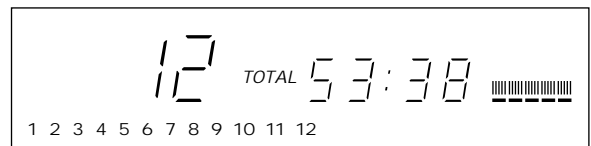

- You can also close the disc tray by pressing the **PLAY** button (or **▶/⏸** button on the front panel), a number button, the **RANDOM** button, or by pressing the front edge of the disc tray gently. If the tray is closed in any of these ways, play will begin automatically, however, the display will not show the total number of tracks and the total recorded time of the disc.

## To turn off the power

Press the **POWER** switch again.

\* If you turn on the power again with a CD in the tray, you can start playing the CD automatically.



## To stop play temporarily

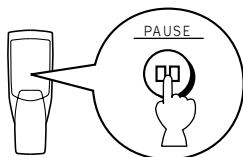

To resume play, press the **PAUSE** button again (or press the **PLAY** button).

\*  $\triangleright / \square$  button on the front panel can also be used to stop play temporarily or to resume play.

## To stop play completely

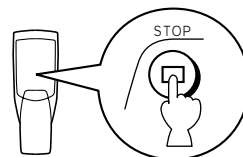

## To play a desired track on the disc

### DIRECT PLAY

Select a desired track using the number buttons.

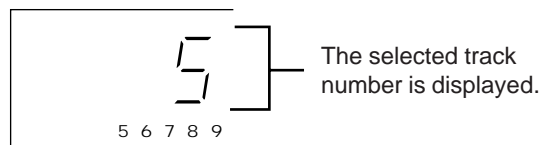
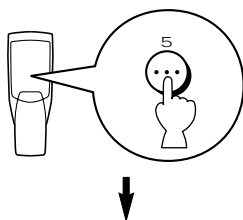

**Example:** To select track 25,  
Press the number 10 button twice, then press the number 5 button once.

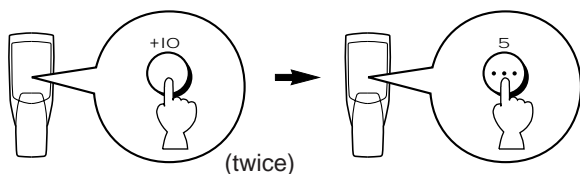

\* If you enter a number that is higher than the last track number on the disc, the final track is played.

### Caution

When the disc tray is open, **do not touch the inside gear wheel**. If you touch the gear wheel, your finger may be caught in the closing tray and injured.

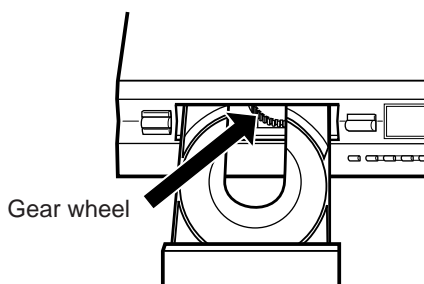

### SKIP PLAY

To skip to a succeeding track, press the **SKIP**  $\triangleright \triangleright$  button once or repeatedly until the desired track number appears.

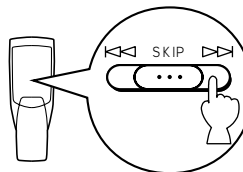

To skip to the beginning of the current track, press the **SKIP**  $\triangleleft \triangleleft$  button once.

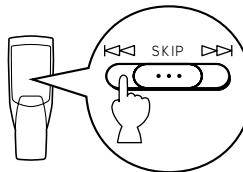

To skip to a preceding track, press the **SKIP**  $\triangleleft \triangleleft$  button repeatedly until the desired track number appears.

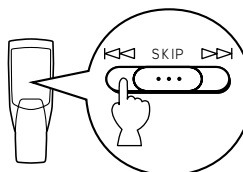

- These operations can also be performed when the unit is in the pause or stop mode.
- When using the **SKIP** button on the remote control transmitter:
  - If the button is pressed and held, the track number continuously changes to higher numbers (or lower numbers).
- When using the **SKIP/SEARCH** button on the front panel:
  - Be careful not to press and hold the button, otherwise the selected track is played forward (or backward) rapidly.

## To advance or reverse play rapidly (MANUAL SEARCH)

### To advance rapidly

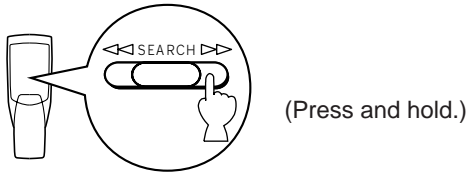

- The sound can be heard (although slightly garbled) during manual search in either direction. This is convenient for locating a precise position within a track, or for reviewing the contents quickly.
- Manual search can also be performed while disc play is paused, though no sound will be heard.
- When using the **SKIP/SEARCH** button on the front panel: Be careful not to release the button just after it is pressed, otherwise the play is skipped to the beginning of the next track or returned to the beginning of the current track.

### To reverse rapidly

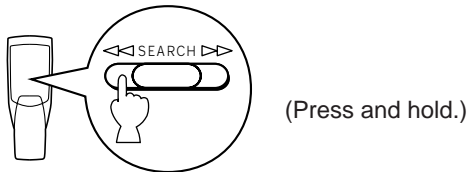

## Selecting time displays

You can select any of the four time displays by pressing the **TIME** display mode-select button.

#### ① Elapsed time of the track now playing

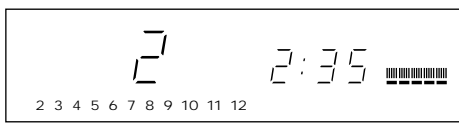

#### ④ Total remaining time on the disc

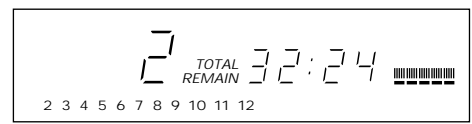

#### ② Remaining time of the track now playing

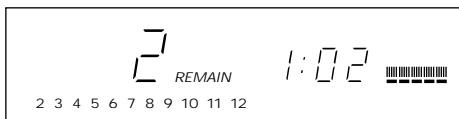

#### ③ Total disc play time

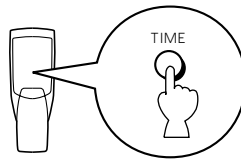

#### Note

The remaining time ② will not be displayed if the track number is 25 or higher.

## Automatic spacing

If you record a disc onto tape with an insufficient time space between tracks, the tape deck will not be able to perform blank search operations on the tape correctly. Such a search mistake of the deck can be prevented by pressing the auto-**SPACE** button to insert spaces of about 4 seconds between the tracks before recording.

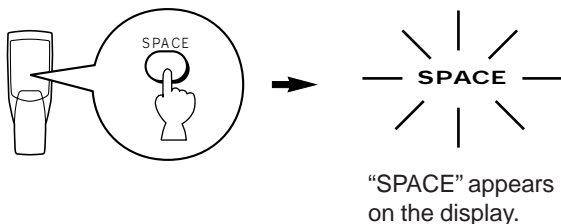

#### Note

When the automatic spacing function is in effect, the display of the total time and of the total remaining time will include each of the 4 second non-recorded intervals placed between tracks.

#### To cancel the automatic spacing function

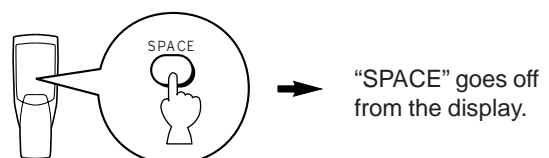

## Changing the brightness of the display

### CDX-593

You can change the brightness of the display (or turn off the illumination) by pressing the **DIMMER** button.

#### During play

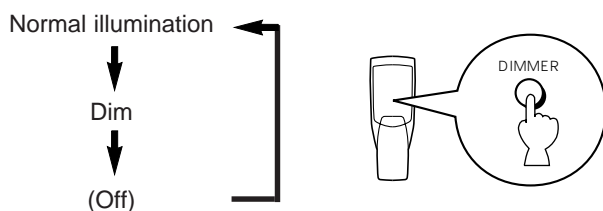

\* While the display illumination is off, the **AUTO DISPLAY OFF** indicator on the front panel is illuminated.

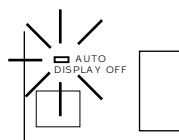

#### During stopped or paused

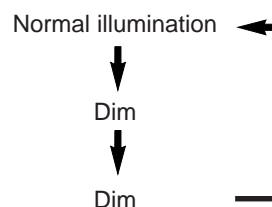

(The **AUTO DISPLAY OFF** indicator lights up. In this state, if a disc is played, the display illumination will be turned off.)

### CDX-493, CDX-393MKII

If desired, you can change the brightness of the display in three degrees by pressing the **DIMMER** button.



## When you listen with headphones

### CDX-593 and CDX-493 only

Connect the headphones to the **PHONES** jack and adjust the volume by using the **OUTPUT LEVEL** button. Note that this adjustment will also vary the signal output level to the amplifier.

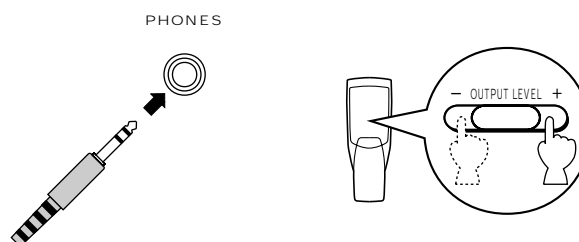

# RANDOM-SEQUENCE PLAY

The unit can play the tracks on a disc in a random sequence selected by the unit's microcomputer.

## To perform random-sequence play

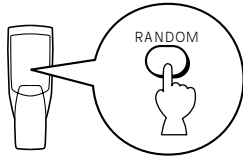

## To cancel random-sequence play

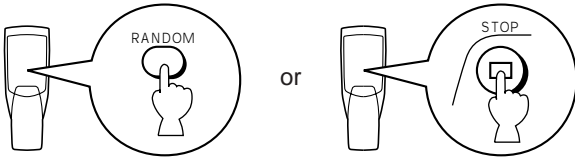

### Notes

- This feature will not function during programming, or during programmed play.
- If the **SKIP** >>> button is pressed during random-sequence play, the next randomly programmed track will be played. If the **SKIP** <<< button is pressed, play will return to the beginning of the current track.

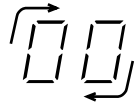
-  This indication appears during random track selection.

- Total remaining time on the disc will not be displayed during random-sequence play.

### **CDX-593 and CDX-493 only**

If the power is switched off during the random-sequence play, pressing the **POWER** switch again to turn the unit on will automatically restore the random-sequence play. This feature is useful for timer play.

# REPEAT PLAY

You can play any desired track or the entire disc repeatedly by pressing the **REPEAT** button. The repeat play mode will change whenever you press the **REPEAT** button.

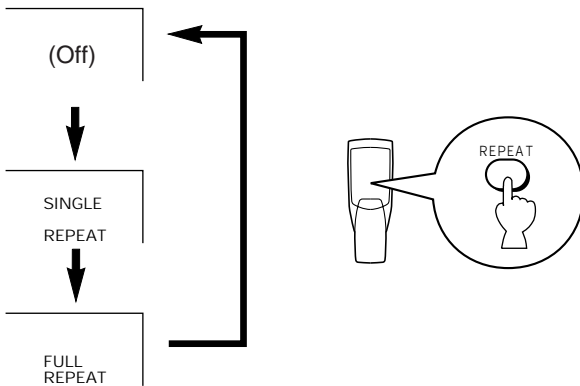

### SINGLE REPEAT

A single track is repeatedly played.

- \* This is also available in the programmed-play mode and the random-sequence play mode.
- \* If the repeat play mode is switched off, the programmed-play mode or the random-sequence play mode will be resumed.

### FULL REPEAT

All tracks (the entire disc) are played repeatedly.

- \* In the programmed-play mode, all programmed tracks are repeatedly played.
- \* In the random-sequence play mode, all randomly sequenced tracks are repeatedly played in the same order.

### **CDX-593 and CDX-493 only**

If the power is switched off during FULL REPEAT play mode, pressing the **POWER** switch again to turn the unit on will automatically restore FULL REPEAT play.

# PROGRAM PLAY

By programming tracks, you can enjoy listening to your favorite tracks in any desired order. As many as 25 tracks can be programmed in sequence.

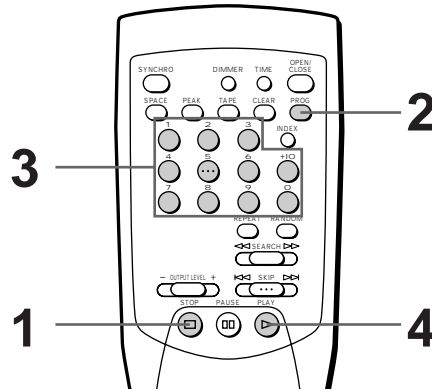

**1** Stop the unit.

**2**

**3** Program a desired track by pressing the corresponding number button.

\* Repeat this operation to program more tracks. You can select the same track again.

**4**

## Display information during programming

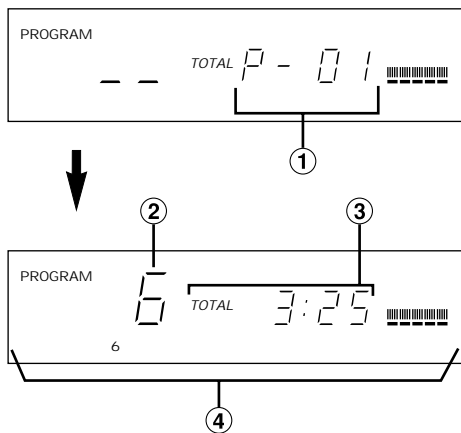

- ① Shows the program number for the track to be entered next.
- ② Shows the selected track number.
- ③ Shows the total time of the tracks currently programmed.
- ④ Shows only the numbers of programmed tracks.

## Notes

- In step 2, if "P-01" does not appear in the display, press the **TIME** display mode-select button.
- If, during programming, the **TIME** display mode-select button is pressed, the program number display is changed to display the total time of the programmed tracks. To return to the previous display, press the **TIME** display mode-select button again.
- The **SKIP** (◀◀ and ▶▶) button can be used during Program Play to skip to tracks within the Program.
- The **SEARCH** (◀◀ and ▶▶) button can be used during Program Play to search all tracks, including unprogrammed tracks.
- You can insert a pause in your program by pressing the **TAPE** button instead of a number button. (In this case, "OO B" appears on the display.)
- If, for a compact disc with 25 tracks or more, track number 25 or higher is programmed, the total time will disappear from the display.

\* If the total time becomes 100 minutes or more, the highest position of a figure will not be displayed.

### To stop program play

Press the **STOP** button. The first programmed track number will be displayed.

To resume play, press the **PLAY** button. Play will begin from the beginning of the program.

### To check program data

1. Press the **STOP** button to stop the program play.
2. Press the **PROG** button.
3. Press the **SKIP**  $\triangleright\triangleright$  button. Each time you press this button, the track number and the program number is displayed in the order of the program. When you want to check the preceding tracks, press the **SKIP**  $\triangleleft\triangleleft$  button.

### To correct program data

1. Follow the procedure described in "To check program data."
2. Display the track number to be corrected by pressing the **SKIP** button.
3. Press a number button to select a track to replace the one displayed. The previously programmed track will be cleared from the memory and the new one will be programmed.
4. After the correction has been completed, press the **PROG** button or the **PLAY** button.

### To cancel a program sequence

There are three methods, as described below.

- Press the **STOP** button or the **CLEAR** button while the unit is stopped.
- Open the disc tray.
- Switch off the power.

## INDEX SEARCH

If the disc includes index numbers, play can be started from any desired index number.

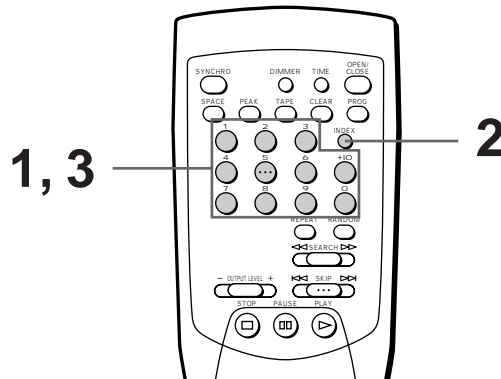

- 1** Select a track which has index numbers.

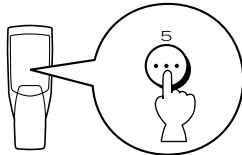

- 2** Press the **INDEX** button. The display shows track 5 and index 01.

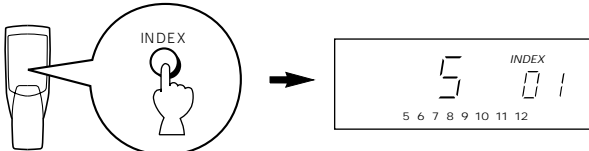

- 3** Select the desired index number.

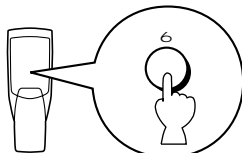

### To cancel the index search function

Press the **INDEX** button.

#### Notes

- Not all discs have index numbers. The index system is a method for sub-dividing tracks into smaller divisions (for example, the movements within classical symphonies) for easier location of those parts. The liner notes with the disc usually tell if such index numbers are included.
- If an index number is selected that is higher than any index number on that disc, play will start from the last index number point on the disc.
- For some discs, play may begin slightly prior to the actual designated index point.
- If the disc has no encoded index points, play will begin from the start of the selected track.
- The index number can be designated only while the **INDEX** number display is illuminated.

# TRACK PROGRAMMING FOR RECORDING TO TAPE

The unit can automatically program tracks considering the tape's total time. This convenient feature can help you to program tracks so that they fit onto the tape with the least amount of unrecorded space remaining at the end of each side (A and B) of the tape.

## Automatic tape-programming

The unit can automatically program tracks on a disc in their original order.

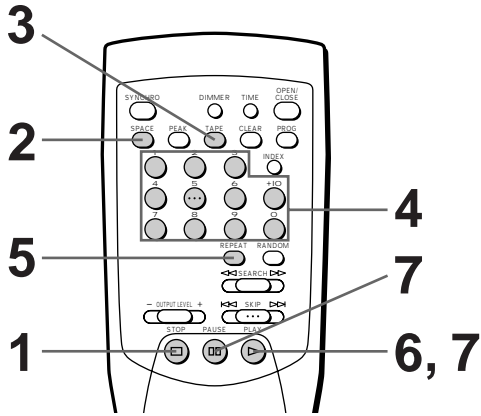

**1** Stop the unit.

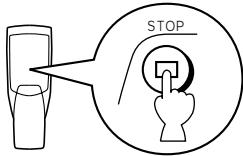

\* The peak level searching function of this unit is useful for adjusting the recording level on the tape deck. (Refer to page 18.)

**2** You can automatically insert additional time space between tracks. (Refer to page 10.)

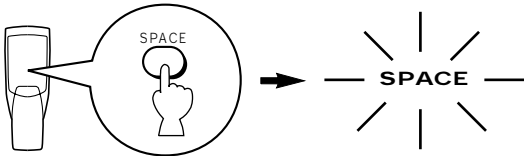

**3** Enter the tape's total possible recording time.

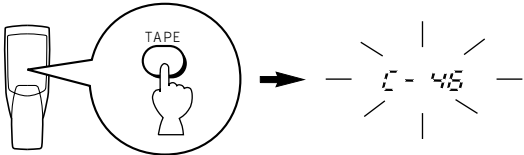

You can select any of four tape lengths by pressing the **TAPE** button.

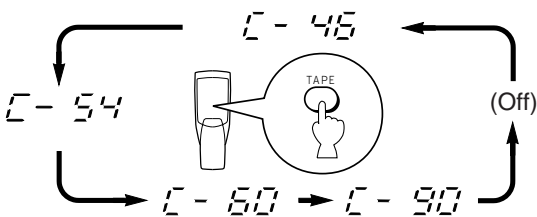

**4** Otherwise, you can enter the tape's total possible recording time manually.  
**Example:** For a C-64 tape (32 minutes on each side)

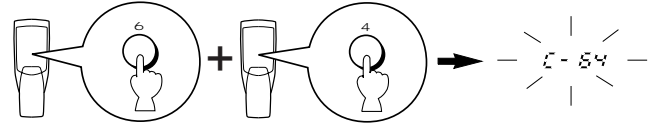

**5** Press the **REPEAT** button.

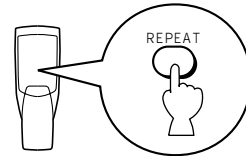

The unit automatically programs tracks for side A and side B separately considering the tape's total time.

**6** Begin recording on the tape deck and press the **PLAY** button on this unit at the same time.

**7** The unit will pause at the end of side A of the tape. Turn the tape over to side B, resume recording and, at the same time, press the **PLAY** or **PAUSE** button on this unit.

### Notes

- All the tracks may not be programmed if the tape's length is not enough. To program all tracks, use a longer tape.
- In step 5, you can check the program data for side A and side B.

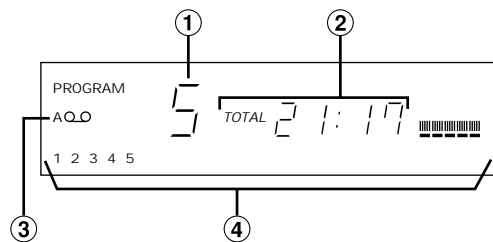

- ① The total number of programmed tracks of each side appears momentarily when the automatic programming is finished. Then the first programmed track number for side A reappears.
- ② Shows the total time of programmed tracks for each side.
- ③ Shows the side of the tape.
- ④ Shows the programmed track numbers for each side.

- To check, cancel or correct program data, refer to page 14.
- \* In checking the program data, note that "Pu" appears between track numbers for side A and side B.
- You can use "CD SYNCHRONIZED RECORDING" if you have a YAMAHA tape deck with this function. In step 6 and 7, press the **SYNCHRO** button then press the **PLAY** button on this unit's remote control transmitter. Recording automatically begins (for details, refer to page 19.)

## Manual tape-programming

For recording tracks in any desired order onto a tape.

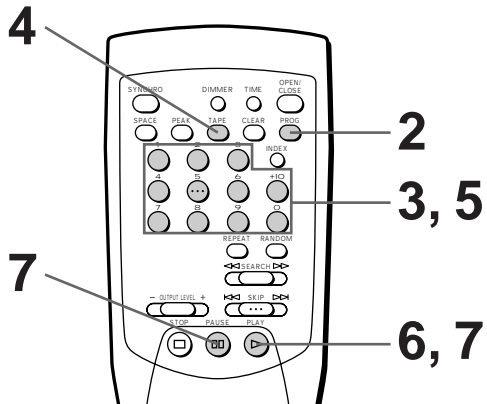

**1** Follow steps 1 – 4 on page 15.

**2**

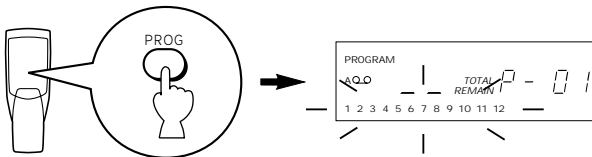

The track numbers you can program flash.

**3** Select the track numbers to be recorded on side A in any desired order.

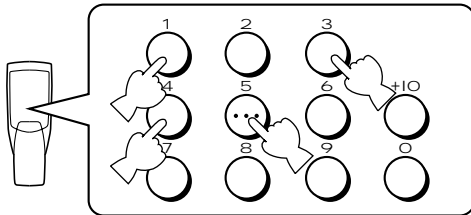

The selected track numbers stop flashing and remain lit. If a track is too long to fit on the remaining portion of side A, the number stops flashing and disappears. You can not program a number that stops flashing and disappears.

**4** When track selection for side A is finished, press the **TAPE** button.

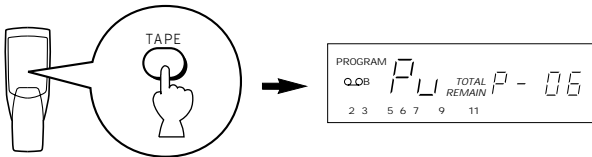

A pause is inserted.

**5** Select the track numbers to be recorded on side B in any desired order.

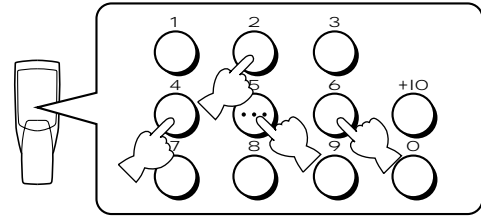

**6** Begin recording on the tape deck and press the **PLAY** button on this unit at the same time.

**7** The unit will pause at the end of side A of the tape. Turn the tape over to side B, resume recording and, at the same time, press the **PLAY** or **PAUSE** button on this unit.

### Notes

- If, in step 3 or 5, "E rr" appears on the display, the track number just selected cannot be programmed because there is not enough time remaining on the tape. However, at this time, if any other track number is flashing continuously on the display, you can program it instead of the unprogrammable one.
- In step 3 or 5, each time a selection is made, the track number and the tape's remaining time will be displayed, and then the display will change to indicate the next program number.
- You can use "CD SYNCHRONIZED RECORDING" if you have a YAMAHA tape deck with this function. In step 6 and 7, press the **SYNCHRO** button then press the **PLAY** button on this unit's remote control transmitter. Recording automatically begins (for details, refer to page 19.)
- To check, cancel or correct program data, refer to page 14.
  - \* In checking the program data, note that "Pu" appears between track numbers for side A and side B.
- A maximum of 25 tracks can be programmed. If you insert a pause in your program, it is counted as one track.
- This function can be used to program up to track number 24. If the disc has more than 24 tracks, track number 25 and thereafter can not be programmed.



## ■ Automatic Random Program tape recording

The unit can automatically program tracks in random order for recording to tape.

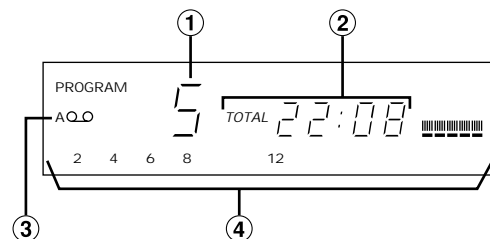
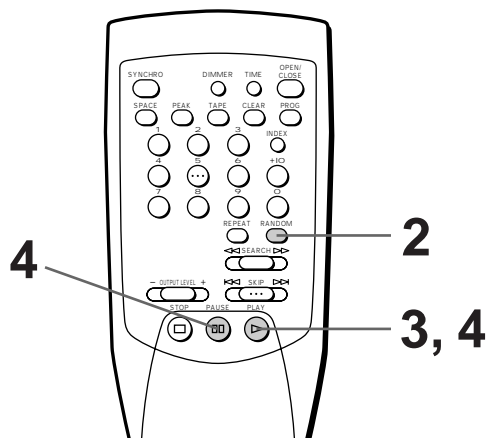

- ① The total number of programmed tracks of each side appears momentarily when the automatic programming is finished. Then the first programmed track number for side A reappears.
- ② Shows the total time of programmed tracks for each side.
- ③ Shows the side of the tape.
- ④ Shows the programmed track numbers for each side.
  - To check, cancel or correct program data, refer to page 14.
  - \* In checking the program data, note that "Pu" appears between track numbers for side A and side B.
- You can use "CD SYNCHRONIZED RECORDING" if your tape deck has this function. In step 3 and 4, press the **SYNCHRO** button then press the **PLAY** button on this unit's remote control transmitter. Recording automatically begins (for details, refer to page 19.)

**1** Follow steps 1 – 4 on page 15.

**2**

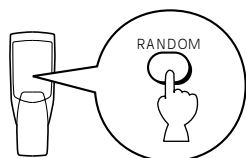

The unit will automatically program tracks for side A and side B separately considering the tape's total time.

**3** Begin recording on the tape deck and at the same time, press the **PLAY** button on this unit.

**4** The unit will pause at the end of side A of the tape. Turn the tape over to side B. Resume recording and, at the same time, press the **PLAY** or **PAUSE** button on this unit.

### Notes

- Because the programmed data changes every time the **RANDOM** button is pressed, the amount of time remaining at the end of the tape also changes accordingly.
- If the tape's length is not enough, not all tracks can be programmed. In this case, exchange the tape for a longer one.
- In step 2, you can check the program data for side A and side B.

## Automatic searching for the peak level on a disc

This convenient feature automatically finds level peak in the source. It then plays the peak repeatedly for a few moments in order for you to adjust the recording level on the tape deck, before you begin recording.

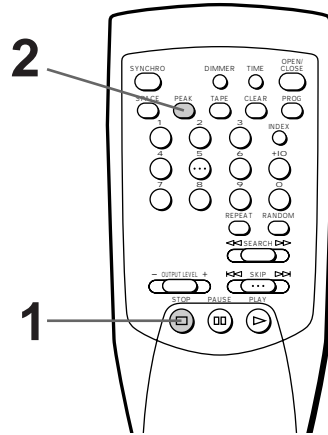

### 1 Stop the unit.

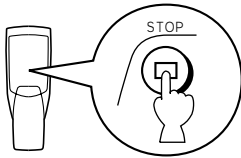

### 2

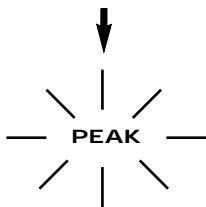
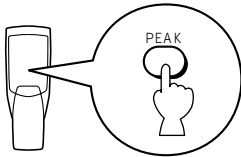

The peak level search is performed on the disc.

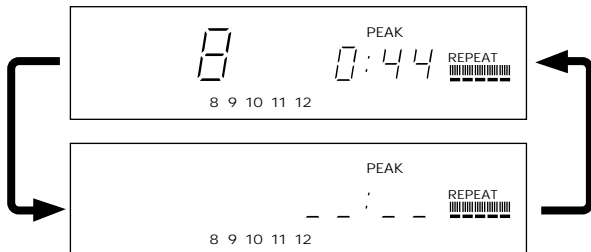

Next, the part where the source level peaks is repeatedly played. Adjust the recording level on the tape deck listening to this sound.

### To cancel this function

Press the **STOP** button. (Some other buttons can also be used to cancel this function.)

### Notes

- Sound peak levels are randomly selected by this unit's internal microcomputer. Therefore, even if a peak search is performed twice or more on the same disc, the same peak may not be selected each time. However, this will not greatly affect the adjustment of recording levels.
- In program play mode, this feature functions with programmed tracks only. If program play is being performed, first press the **STOP** button, and then press the **PEAK** button. If program play is not being performed, press only the **PEAK** button.

# CD SYNCHRONIZED RECORDING

This unit can perform automatic synchronized CD to tape recording. With this function, you can record a CD on tape very easily and more precisely.

This recording method requires a YAMAHA tape deck compatible with this function. (Refer to the tape deck's operation manual to know whether it is compatible or not.)

\* This unit and the tape deck must be placed near each other so that both can receive the signals from this unit's remote control transmitter.

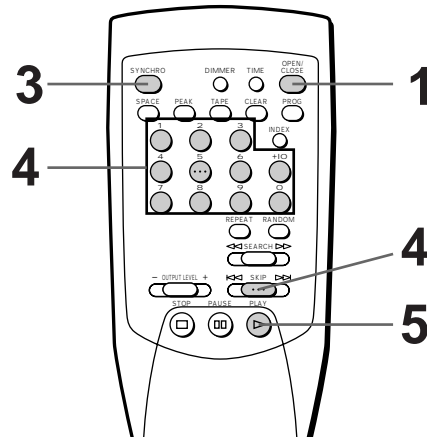

**1** Load the disc.

**2** Load a tape on the tape deck.  
\* The peak level search function of this unit is useful for adjusting the recording level on the tape deck. (Refer to page 18.)

**3**

This unit enters into the pause mode, and the tape deck enters into the REC/PAUSE mode.  
\* In this mode, the time display on this unit flashes on and off.

**4** If necessary, select a desired track.

**5**

Both CD play and tape deck recording begin.  
\* CD play begins a little later than recording starts.

**6** If you want to stop recording temporarily and restart recording from a desired track, follow steps 3 – 5 again.

### To cancel this function

Press the **STOP** button.

### Notes

- To finish or stop the recording, press the stop button on your tape deck.
- A programmed sequence of tracks can also be recorded with this function, instead of recording an entire disc. (Refer to page 13 – 14 for the programming procedure.)
- This function can also be used together with the automatic tape-programming function. (Refer to page 15 – 17.)

# NOTES ABOUT THE REMOTE CONTROL TRANSMITTER

## Battery installation

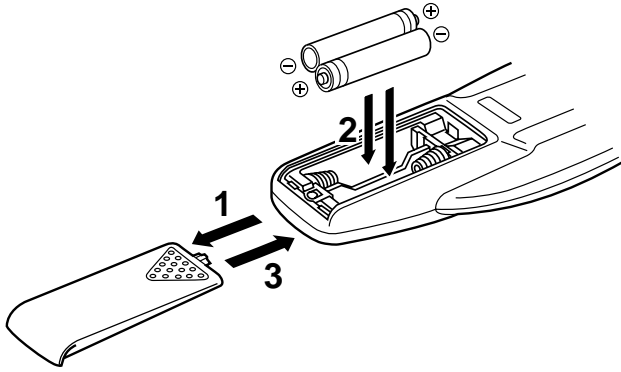

## Battery replacement

If you find that the remote control transmitter must be used closer to the main unit than usual, the batteries are weak. Replace both batteries with new ones.

### Notes

- Use only AA, R6, UM-3 batteries for replacement.
- Be sure the polarities are correct. (See the illustration inside the battery compartment.)
- Remove the batteries if the remote control transmitter will not be used for an extended period of time.
- If batteries leak, dispose of them immediately. Avoid touching the leaked material or letting it come in contact with clothing, etc. Clean the battery compartment thoroughly before installing new batteries.

## Remote control transmitter operation range

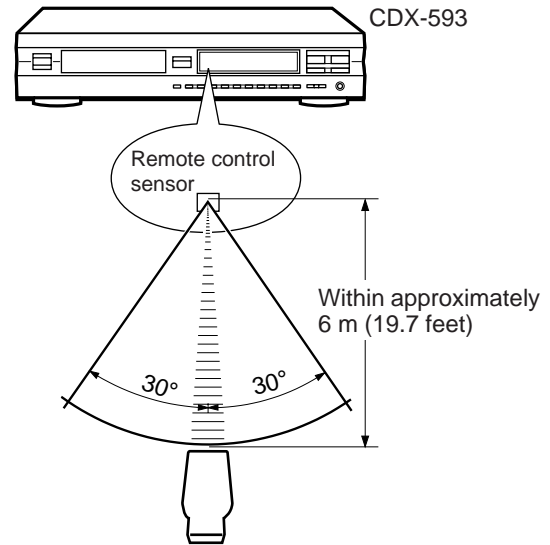

### Notes

- There should be no large obstacles between the remote control transmitter and the main unit.
- If the remote control sensor is directly illuminated by strong lighting (especially an inverter type of fluorescent lamp etc.), it might cause the remote control transmitter not to work correctly. In this case, reposition the main unit to avoid direct lighting.

# NOTES ABOUT HANDLING COMPACT DISCS

- This compact disc player is designed only for playing compact discs bearing the  mark. Never attempt to load any other type of disc into the unit. The unit will also play 8-cm (3-inch) compact discs.
- To remove a disc from its storage case, open the case and then press down at the center; with a finger through the center hole and the outer edges held as shown in the illustration, lift the disc out carefully.

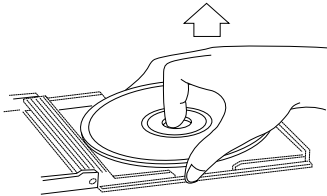

- Always handle the disc with care so that its surface is not scratched.

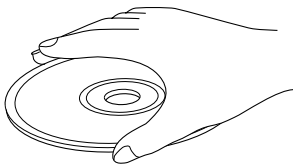

- Compact discs are not subjected to wear during play, but damage to the disc surface when the disc is being handled can adversely affect the disc's play.

- Compact discs are not affected by small particles of dust or fingerprints on their playing surface, but even so they should be kept clean. Wipe by using a clean, dry cloth. Do not wipe with a circular motion; wipe straight outward from the center.

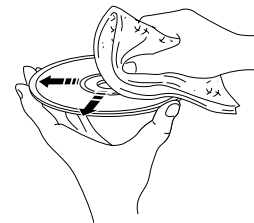

- Do not try to clean the disc's surface by using any type of disc cleaner, record spray, anti-static spray or liquid, or any other chemical-based liquid, because such substances might irreparably damage the disc's surface.
- Do not expose discs to direct sunlight, high temperature or high humidity for a long period of time, because these might warp or otherwise damage the disc.

**No!**



## To play a 8-cm (3-inch) CD

Place it in the inner recessed area of the disc tray. Do not put a normal (12-cm/5-inch) CD on top of a 8-cm CD.

# TROUBLESHOOTING

If the unit fails to operate normally, check the following points to determine whether the fault can be corrected by the simple measures suggested. If it cannot be corrected, or if the fault is not listed in the SYMPTOM column, disconnect the power cord and contact your authorized YAMAHA dealer or service center for help.

SYMPTOM	PROBABLE CAUSE	REMEDY
<b>The player does not switch ON when the POWER switch is pressed.</b>	The power cord is not connected or not completely connected.	Securely connect the power cord.
<b>It happens that this unit does not work normally.</b>	There is an influence of strong external noise (lightning, excessive static electricity, etc.) or a misoperation was performed while using this unit.	Turn this unit power off and disconnect the AC power from the AC outlet. After about 30 seconds have passed, connect the power and try again.
<b>The disc tray does not close completely.</b>	A foreign object is obstructing the tray.	Carefully check the disc tray and remove the foreign object.
<b>Play does not begin.</b>	The disc is damaged.	Check the disc carefully; replace it if necessary.
	There is moisture on the laser pickup.	Wait 20 to 30 minutes after switching the unit ON before trying to play a disc.
	The disc has been loaded upside down.	Reload the disc with the label side up.
	The disc is dirty.	Clean the disc.
<b>Play is delayed, or begins at the wrong place.</b>	The disc may be scratched or damaged.	Check the disc carefully; replace it if necessary.
<b>No sound.</b>	Improper output cable connections.	Connect the cables properly. If the problem persists, the cables may be defective.
	Improper amplifier operation.	Set the amplifier controls to the correct input selection.
<b>Sound "skips."</b>	The player is being subjected to vibrations or impacts.	Relocate the player.
	The disc is dirty.	Clean the disc.
<b>Sound "hums."</b>	Improper cable connections.	Securely connect the audio cables. If the problem persists, the cables may be defective.
<b>Noise from a nearby tuner.</b>	The tuner is too close to the player.	Move the tuner and player farther apart.
<b>Noise from inside of the disc tray.</b>	The disc may be warped.	Replace the disc.
<b>The remote control transmitter does not work.</b>	The batteries of this remote control transmitter are too weak.	Replace the batteries with new ones.
	Direct sunlight or lighting (of an inverter type of fluorescent lamp etc.) is striking the remote control sensor of the main unit.	Change position of the main unit.

# SPECIFICATIONS

---

## AUDIO SECTION

Frequency response ..... 2 Hz – 20 kHz,  $\pm 0.5$  dB

### Harmonic distortion + noise (1 kHz)

<CDX-593> ..... 0.0025% or less

<CDX-493, CDX-393MKII> ..... 0.003% or less

### S/N ratio

<CDX-593> ..... 115 dB or more

<CDX-493, CDX-393MKII> ..... 105 dB or more

### Dynamic range

<CDX-593> ..... 98 dB or more

<CDX-493, CDX-393MKII> ..... 95 dB or more

Wow & flutter ..... Unmeasurable

Output voltage (1 kHz, 0 dB) .....  $2.0 \pm 0.5$  V

### Headphones output (-20 dB)

<CDX-593 and CDX-493 only> .....  $200 \pm 40$  mV/150 ohms

## GENERAL

### Power requirements

U.S.A. and Canada models ..... 120 V, 60 Hz

Australia model ..... 240 V, 50 Hz

Europe and U.K. models ..... 230 V, 50 Hz

General model ..... 110/120/220/240 V, 50/60 Hz

Power consumption ..... 20 W

### Dimensions (W $\times$ H $\times$ D)

<CDX-593, CDX-493> .....  $435 \times 96 \times 272$  mm  
(17-1/4"  $\times$  3-7/8"  $\times$  10-3/4")

<CDX-393MKII> .....  $435 \times 96 \times 273$  mm  
(17-1/4"  $\times$  3-7/8"  $\times$  10-3/4")

### Weight

<CDX-593, CDX-493> ..... 3.6 kg (7 lbs. 15 oz.)

<CDX-393MKII> ..... 3.5 kg (7 lbs. 11 oz.)

Accessories ..... Connection cord

Remote control transmitter

Batteries (size AA, R6, UM-3)

Please note that all specifications are subject to change without notice.



---

YAMAHA ELECTRONICS CORPORATION, USA 6660 ORANGETHORPE AVE., BUENA PARK, CALIF. 90620, U.S.A.  
YAMAHA CANADA MUSIC LTD. 135 MILNER AVE., SCARBOROUGH, ONTARIO M1S 3R1, CANADA  
YAMAHA ELECTRONIK EUROPA G.m.b.H. SIEMENSSTR. 22-34, 25462 RELLINGEN BEI HAMBURG, F.R. OF GERMANY  
YAMAHA ELECTRONIQUE FRANCE S.A. RUE AMBROISE CROIZAT BP70 CROISSY-BEAUBOURG 77312 MARNE-LA-VALLEE CEDEX02, FRANCE  
YAMAHA ELECTRONICS (UK) LTD. YAMAHA HOUSE, 200 RICKMANSWORTH ROAD WATFORD, HERTS WD1 7JS, ENGLAND  
YAMAHA SCANDINAVIA A.B. J A WETTERGRENS GATA 1, BOX 30053, 400 43 VÄSTRA FRÖLUNDA, SWEDEN  
YAMAHA MUSIC AUSTRALIA PTY, LTD. 17-33 MARKET ST., SOUTH MELBOURNE, 3205 VIC., AUSTRALIA

YAMAHA CORPORATION  
Printed in Malaysia  V 341210