

YAMAHA KMS-301

Natural Sound
Bass-Reflex Type
Full-Range Speaker System

Thank you for selecting this Yamaha KMS-301 speaker system.

PRECAUTIONS

Read these precautions carefully before operating your speaker system.

- Any time you note distortion, reduce the volume control on your amplifier to a lower setting. Never allow your amplifier to be driven into "clipping". Otherwise, the speaker may be damaged.
- This speaker system incorporates a speaker protector. However, if you will drive speakers with a high-power amplifier, first decrease the volume to minimum, then turn the power on, and increase the volume slowly. If high power output above a certain level is applied to the speakers suddenly, the protector will not function and so the speakers will be damaged.
- Do not attempt to clean the speaker with chemical solvents as this might damage the finish. To clean, wipe with a dry, soft cloth.
- To prevent the enclosure from warping or discoloring, do not place the speaker where it will be exposed to direct sunlight or excessive humidity.
- Do not place the speaker where it is liable to be knocked over or struck by falling objects. Stable placement will also ensure better sound performance.
- Placing the speaker on the same shelf or rack as the turntable can result in feedback.
- **Secure placement or installation is the owner's responsibility.**
YAMAHA shall not be liable for any accident caused by improper placement or installation of the speaker.

CONNECTING TO YOUR AMPLIFIER

BEFORE MAKING CONNECTIONS, MAKE SURE THAT THE AMPLIFIER IS SWITCHED OFF.

■ CONNECTIONS

- Connect the push-type input terminals at the rear of the speakers to the speaker output terminals of your amplifier with commercially available speaker cables.

- Connect the left speaker to the left (marked L) terminals of your amplifier, and the right speaker to the right (marked R) terminals, making sure not to reverse the polarity (+, -). If one speaker is connected with reversed polarity, the sound will be unnatural and lack bass.

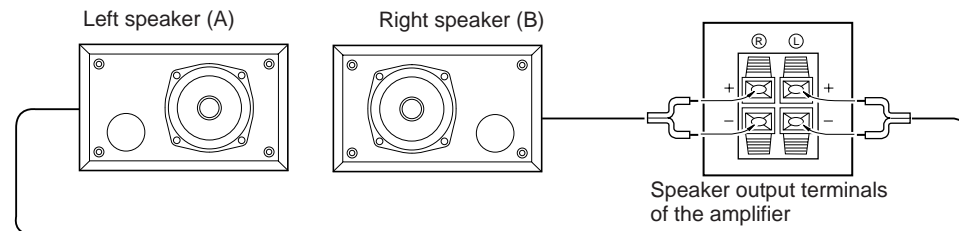

Procedures:

- ① Press the tab on the terminal down, as shown in the figure.
- ② Insert the bare wire end properly into the terminal hole. [Remove approx. 10 mm (3/8") insulation from the speaker cable.]
- ③ Remove your finger from the tab to allow it to lock snugly on the cable's wire end.
- ④ Test the security of the connection by tugging lightly on the cable at the terminal.

Note

Do not let the bare speaker wires touch each other as this could damage the speaker and/or the amplifier.

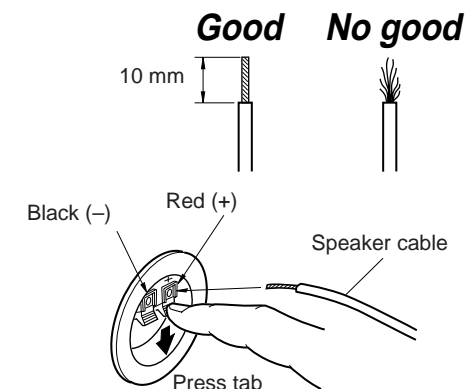

PLACING THE SPEAKER

This speaker system is designed for use in a side long way.

Left speaker (A)

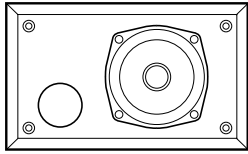

Right speaker (B)

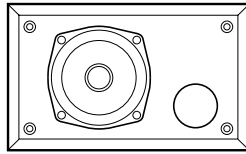

Note

Though this speaker system is a magnetic shielding type, there may be an influence on TV picture according to the type of TV or the placement of the speakers. In such a case, place the speakers apart from the TV so that there is no influence on TV picture.

You can also use the screw holes on the rear or on top of the speaker for installing the speakers on the wall or the ceiling by using commercially available mounting brackets.

Rear

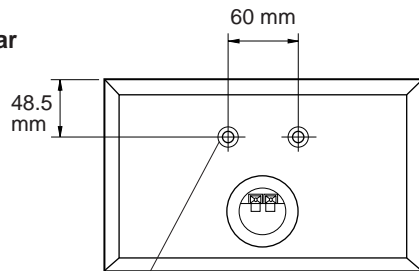

A screw with a diameter of 5 mm and a pitch of 0.8 mm can be used.
(Depth of hole : 8 mm)

Top

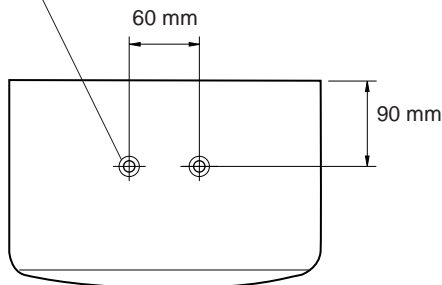

WARNING

- The required length of a screw differs depending on the mounting bracket to be used. Select a screw which is suitable for use with the mounting bracket and can be fully inserted into the hole on the speaker.
- Each speaker weigh 3.0 kg (6 lbs. 10 oz.). Do not attach them to thin plywoods or soft wall surface materials, as the screws may tear free from flimsy surfaces, causing the speakers to fall and be damaged, or result in personal injury.
- Do not fasten the speakers to walls with nails, adhesives, or other unsound hardware. Long-term use and vibrations may cause them to pull free.
- To avoid accidents resulting from tripping over loose speaker cables, fix these to the wall along with the speakers.

SPECIFICATIONS

Type.....	Full-range bass-reflex speaker system Magnetic-shielding type (EIAJ)
Speaker Unit.....	12 cm cone type (JA1234)
Input Terminal	Push-type
Nominal Impedance.....	6 ohms
Frequency Response.....	50 Hz – 20 kHz (–15 dB)
Nominal Input Power.....	40W
Maximum Input Power	120W
Sensitivity	90 dB/w/m
Dimensions (WxHxD).....	273 x 167 x 211 mm (10- ³ / ₄ " x 6- ⁹ / ₁₆ " x 8- ⁵ / ₁₆ ")
Weight.....	3.0 kg (6 lbs. 10 oz.)

* Specifications subject to change without notice due to product improvements.

* Care should be taken not to exceed the input power values noted above.

REMOVING THE FRONT COVER

The front cover is fastened to the enclosure at four points, and can be removed if desired. To remove the cover, hold on to both sides and slowly pull straight away from the speaker. To reattach, line up the four pegs on the inside surface of the cover with the four corresponding holes on the speaker and push gently.

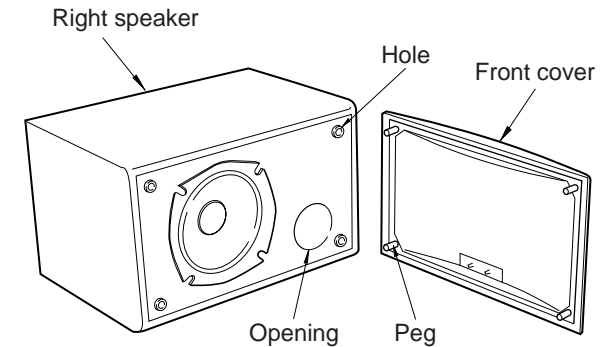

Notes

- When the cover is removed, take care not to touch the speaker units with your hands or to exert excessive force with tools.

- This bass-reflex type speaker has an opening on the front side.

Be careful not to obstruct the opening or put some objects into it. If doing so, the sound will be unnatural or it may cause damage to the speaker and/or amplifier.

Built-in speaker protector

This speaker system incorporates a speaker protector which protects the speakers from excessive input. Once an excessive input is applied to the speakers, the protector functions and cuts out sound output from the speakers. If it occurs, decrease the volume on the amplifier. After several seconds, the protector stops automatically and sound output revives.