

DSP-Z9



AV Amplifier
Amplificateur Audio-Vidéo

OWNER'S MANUAL
MODE D'EMPLOI
BEDIENUNGSANLEITUNG

CAUTION: READ THIS BEFORE OPERATING YOUR UNIT.

- 1 To assure the finest performance, please read this manual carefully. Keep it in a safe place for future reference.
- 2 Install this sound system in a well ventilated, cool, dry, clean place — away from direct sunlight, heat sources, vibration, dust, moisture, and/or cold. Allow ventilation space of at least 30 cm on the top, 20 cm on the left and right, and 20 cm on the back of this unit.
- 3 Locate this unit away from other electrical appliances, motors, or transformers to avoid humming sounds.
- 4 Do not expose this unit to sudden temperature changes from cold to hot, and do not locate this unit in an environment with high humidity (i.e. a room with a humidifier) to prevent condensation inside this unit, which may cause an electrical shock, fire, damage to this unit, and/or personal injury.
- 5 Avoid installing this unit where foreign object may fall onto this unit and/or this unit may be exposed to liquid dripping or splashing. On the top of this unit, do not place:
 - Other components, as they may cause damage and/or discoloration on the surface of this unit.
 - Burning objects (i.e. candles), as they may cause fire, damage to this unit, and/or personal injury.
 - Containers with liquid in them, as they may fall and liquid may cause electrical shock to the user and/or damage to this unit.
- 6 Do not cover this unit with a newspaper, tablecloth, curtain, etc. in order not to obstruct heat radiation. If the temperature inside this unit rises, it may cause fire, damage to this unit, and/or personal injury.
- 7 Do not plug in this unit to a wall outlet until all connections are complete.
- 8 Do not operate this unit upside-down. It may overheat, possibly causing damage.
- 9 Do not use force on switches, knobs and/or cords.
- 10 When disconnecting the power cord from the wall outlet, grasp the plug; do not pull the cord.
- 11 Do not clean this unit with chemical solvents; this might damage the finish. Use a clean, dry cloth.
- 12 Only voltage specified on this unit must be used. Using this unit with a higher voltage than specified is dangerous and may cause fire, damage to this unit, and/or personal injury. YAMAHA will not be held responsible for any damage resulting from use of this unit with a voltage other than specified.
- 13 To prevent damage by lightning, disconnect the power cord from the wall outlet during an electrical storm.
- 14 Do not attempt to modify or fix this unit. Contact qualified YAMAHA service personnel when any service is needed. The cabinet should never be opened for any reasons.
- 15 When not planning to use this unit for long periods of time (i.e. vacation), disconnect the AC power plug from the wall outlet.
- 16 Be sure to read the “TROUBLESHOOTING” section on common operating errors before concluding that this unit is faulty.
- 17 Before moving this unit, press STANDBY/ON to set this unit in the standby mode, and disconnect the AC power plug from the wall outlet.
- 18 **VOLTAGE SELECTOR** (General model only)
The **VOLTAGE SELECTOR** on the rear panel of this unit must be set for your local main voltage **BEFORE** plugging into the AC main supply. Voltages are 110/120/220/230-240 V AC, 50/60 Hz.

This unit is not disconnected from the AC power source as long as it is connected to the wall outlet, even if this unit itself is turned off. This state is called the standby mode. In this state, this unit is designed to consume a very small quantity of power.

WARNING

TO REDUCE THE RISK OF FIRE OR ELECTRIC SHOCK, DO NOT EXPOSE THIS UNIT TO RAIN OR MOISTURE.

■ For U.K. customers

If the socket outlets in the home are not suitable for the plug supplied with this appliance, it should be cut off and an appropriate 3 pin plug fitted. For details, refer to the instructions described below.

Note

The plug severed from the mains lead must be destroyed, as a plug with bared flexible cord is hazardous if engaged in a live socket outlet.

■ Special Instructions for U.K. Model

IMPORTANT

THE WIRES IN MAINS LEAD ARE COLOURED IN ACCORDANCE WITH THE FOLLOWING CODE:

Blue: NEUTRAL

Brown: LIVE

As the colours of the wires in the mains lead of this apparatus may not correspond with the coloured markings identifying the terminals in your plug, proceed as follows:

The wire which is coloured BLUE must be connected to the terminal which is marked with the letter N or coloured BLACK. The wire which is coloured BROWN must be connected to the terminal which is marked with the letter L or coloured RED.

Making sure that neither core is connected to the earth terminal of the three pin plug.

CONTENTS

INTRODUCTION

FEATURES	2
GETTING STARTED	3
Supplied accessories	3
Installing batteries in the remote controls	4
CONTROLS AND FUNCTIONS	5
Front panel	5
Remote control	7
GUI remote control	8
Using the remote controls	9
Front panel display	10
Rear panel	11

PREPARATION

SPEAKER SETUP	12
Speaker placement	12
Speaker connections	13
CONNECTIONS	16
Connecting components	16
Connecting video components	17
Connecting audio components	24
Connecting the power supply cord	27
Speaker impedance setting	28
Turning on the power	28
USING THE GUI REMOTE CONTROL	29
GUI remote control operations	29
AUTO SETUP	31
Introduction	31
Optimizer microphone setup	31
Starting the setup	32
Confirming the results	34

BASIC OPERATION

PLAYBACK	37
Basic operations	37
Selecting sound field programs	39
Listening to uncompromising pure audio	43
Selecting input modes	44
RECORDING	46

SOUND FIELD PROGRAMS

SOUND FIELD PROGRAM DESCRIPTIONS	48
For movie/video sources	48
For music sources	51

ADVANCED OPERATION

ADVANCED OPERATIONS	53
Selecting the OSD mode	53
Using the sleep timer	53
Using the test tone	54
SYSTEM OPTIONS	55
Changing parameter settings	57
Input Select	58
Manual setup: Sound	61
Manual setup: Basic	64
Manual setup: Video	71
Manual setup: Option	75
Memory Guard	78
REMOTE CONTROL FEATURES	80
Control area	80
Setting manufacturer codes	81
Programming codes from other remote controls	82
Changing source names in the display window	83
Using the macro feature	84
Clearing function sets	86
Clearing individual functions	87
Controlling components	88
ZONE 2	93
Zone 2 connections	93
Remote controlling Zone 2	94
USING i.LINK	96
What is i.LINK?	96
Connecting i.LINK components	96
Assigning i.LINK components	97
Listening to playback from an i.LINK component	97
Changing i.LINK Select parameters	98
i.LINK display messages	100

ADDITIONAL INFORMATION

SOUND FIELD OPTIONS	101
What is a sound field	101
Stereo/Surround menu	103
TROUBLESHOOTING	108
PARAMETRIC EQUALIZER INFORMATION	112
GLOSSARY	113
BLOCK DIAGRAMS	117
SPECIFICATIONS	119

INTRODUCTION

PREPARATION

BASIC OPERATION

SOUND FIELD PROGRAMS

ADVANCED OPERATION

ADDITIONAL INFORMATION

English

FEATURES

Built-in 9-channel power amplifier

- ◆ Minimum RMS output power (0.015% THD, 20 Hz – 20 kHz, 8Ω)
Front: 170 W + 170 W
Center: 170 W
Surround: 170 W + 170 W
Surround back: 170 W + 170 W
Presence: 50 W + 50 W

Sound field features

- ◆ Proprietary YAMAHA technology for the creation of sound fields
- ◆ THX Ultra 2
- ◆ Dolby Digital/Dolby Digital EX decoder
- ◆ Dolby Pro Logic/Dolby Pro Logic II/Dolby Pro Logic IIx decoder
- ◆ DTS/DTS ES Matrix 6.1, Discrete 6.1/DTS 96/24 decoder
- ◆ DTS Neo:6 decoder
- ◆ Virtual CINEMA DSP
- ◆ SILENT CINEMA™

Other features

- ◆ YPAO: YAMAHA Parametric Room Acoustic Optimizer for automatic speaker setup
- ◆ 192-kHz/24-bit D/A converter
- ◆ On-screen display menus that allow you to optimize this unit to suit your individual audio/video system
- ◆ 8-channel external decoder input for other future formats (compatible with DSP)
- ◆ PURE DIRECT for pure fidelity sound with multi or 2-channel sources
- ◆ On-screen display function with dedicated GUI remote control for performing all operations
- ◆ S Video signal input/output capability
- ◆ Component video input/output capability
- ◆ Video signal conversion (Composite video ↔ S Video ↔ Component video) capability for monitor out
- ◆ Faroudja DCDi for progressive video output
- ◆ Faroudja True Life Enhancer for smooth video images
- ◆ TBC (Time Base Corrector) for jitterless video images
- ◆ i.LINK interface for direct digital transfer of digital audio signals
- ◆ Optical and coaxial digital audio signal jacks
- ◆ Sleep timer
- ◆ Night listening mode
- ◆ Remote control with preset manufacturer codes and “learning” macro capability
- ◆ Zone 2 custom installation facility

-  indicates a tip for your operation.
- Some operations can be performed by using either the buttons on the main unit or on the remote control. In cases where the button names differ between the main unit and remote control, the button name on the remote control is given in parentheses.
- This manual is printed prior to production. Design and specifications are subject to change in part as a result of improvements, etc. In case of differences between the manual and product, the product has priority.



Manufactured under license from Dolby Laboratories. “Dolby”, “Pro Logic”, “Surround EX”, and the double-D symbol are trademarks of Dolby Laboratories.

SILENT CINEMA is a trademark of YAMAHA CORPORATION.



“DCDi” is a trademark of Faroudja, a division of Genesis Microchip, Inc.



“DTS”, “DTS-ES Digital Surround”, “Neo:6” and “DTS 96/24” are trademarks of Digital Theater Systems, Inc.



“THX” and the “THX” logo are registered trademarks of THX Ltd. “Surround EX” is a jointly developed technology of THX and Dolby Laboratories, Inc. and is a trademark of Dolby Laboratories, Inc. All rights reserved. Used under authorization.

“i.LINK” and the “i.LINK” logo  are trademarks of Sony Corporation.

GETTING STARTED

Supplied accessories

Please check that you received all of the following parts.

Remote control

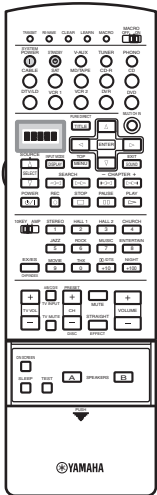

GUI Remote control

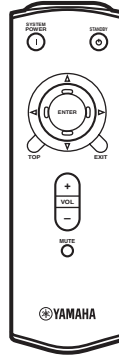

**Batteries (3)
(AA, LR6)**

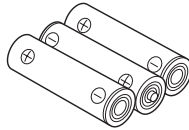

**Batteries (2)
(AAA, R03)**

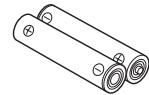

Power cord

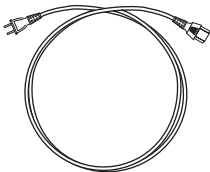

Speaker terminal wrench

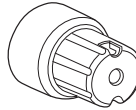

Optimizer microphone

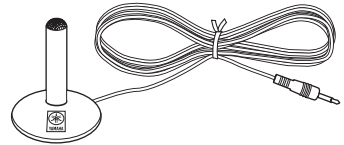

* The optimizer microphone is sensitive to heat.
– Keep it away from direct sunlight.
– Do not place it on top of this unit.

Installing batteries in the remote controls

Notes on batteries

- Change all of the batteries if you notice the following conditions: the operation range of the remote control decreases, the indicator does not flash or its light becomes dim.
- Do not use old batteries together with new ones.
- Do not use different types of batteries (such as alkaline and manganese batteries) together. Read the packaging carefully as these different types of batteries may have the same shape and color.
- If the batteries have leaked, dispose of them immediately. Avoid touching the leaked material or letting it come into contact with clothing, etc. Clean the battery compartment thoroughly before installing new batteries.

■ Remote control

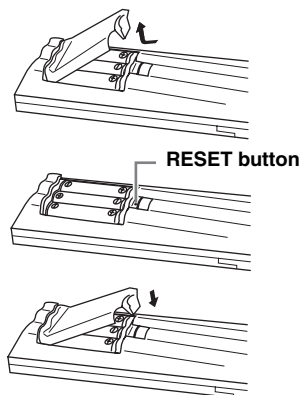

- 1** Open the battery compartment cover.
- 2** Insert three supplied batteries (AA, LR6) according to the polarity markings (+ and –) on the inside of the battery compartment.
- 3** After new batteries are correctly inserted, press the **RESET** button in the battery compartment using a ball point pen or similar object.
(This does not clear the contents of the memory.)
- 4** Replace the cover by pressing until it snaps into place.

If the remote control is without batteries for more than 3 minutes, or if exhausted batteries remain in the remote control, the contents of the memory may be cleared. If the memory is cleared, insert new batteries, set up the manufacturer code(s) and program any acquired functions that may have been cleared.

■ GUI remote control

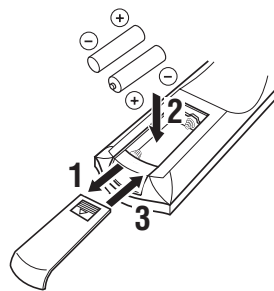

- 1** Press the ▼ part and slide the battery compartment cover off.
- 2** Insert two supplied batteries (AAA, R03) according to the polarity markings (+ and –) on the inside of the battery compartment.
- 3** Slide the cover back until it snaps into place.

CONTROLS AND FUNCTIONS

Front panel

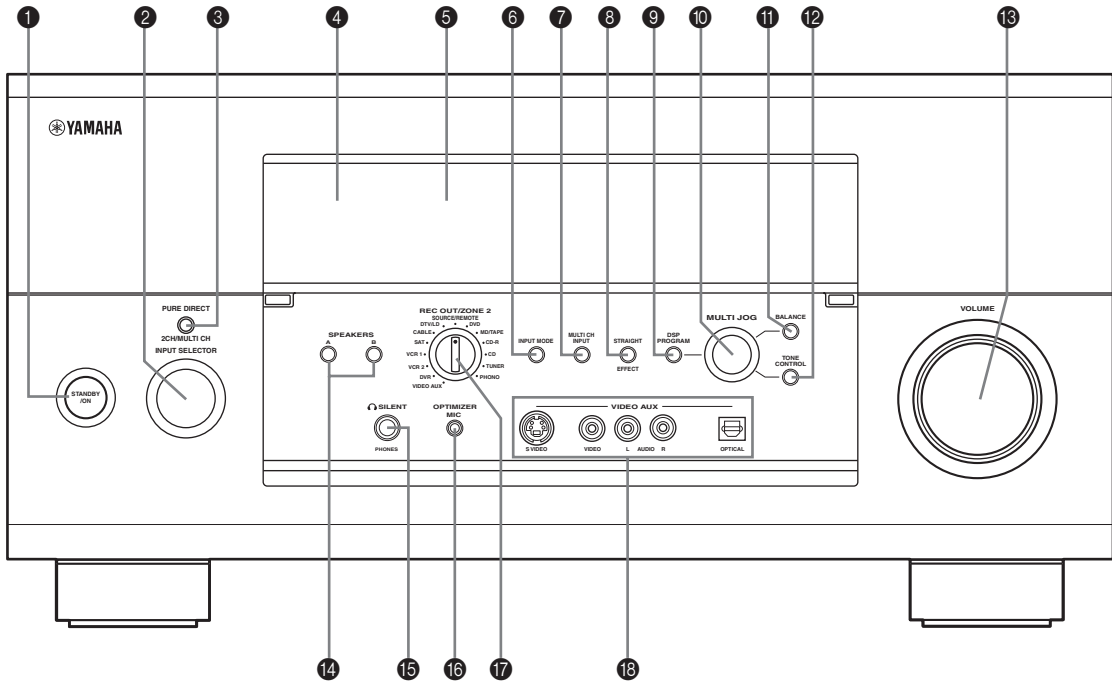

1 STANDBY/ON

Turns on this unit or sets it to the standby mode. When you turn on this unit, you will hear a click and there will be a delay of a few seconds before this unit can reproduce sound.

Note

In standby mode, this unit consumes a small amount of power in order to receive infrared-signals from the remote controls.

2 INPUT SELECTOR

Selects the input source you want to listen to or watch.

3 PURE DIRECT 2CH/MULTI CH

Turns on or off the 2-channel/multi-channel PURE DIRECT mode (see page 43).

4 Remote control sensor

Receives signals from the remote controls.

5 Front panel display

Shows information about the operational status of this unit.

6 INPUT MODE

Sets the priority for the type of input signal (AUTO, i.LINK, DTS, DIGITAL, D.D.RF, ANALOG) received when one component is connected to two or more input jacks on this unit (see page 44).

7 MULTI CH INPUT

Selects the source connected to the MULTI CH INPUT jacks. This source takes priority over the source selected with INPUT SELECTOR (or the input selector buttons on the remote control).

8 STRAIGHT/EFFECT

Switches the sound fields off or on. When STRAIGHT is selected, input signals (2-channel or multi-channel) are output directly from their respective speakers without effect processing.

9 DSP PROGRAM

Press this button before rotating MULTI JOG to select sound field programs.

10 MULTI JOG

Rotate to select or adjust items when used with the DSP PROGRAM, BALANCE or TONE CONTROL buttons.

11 BALANCE

Adjusts the left/right balance of the front, presence, surround and surround back speakers.

12 TONE CONTROL

Press this button before rotating MULTI JOG to adjust the bass/treble balance for the front left/right, center and subwoofer channels (see page 38).

13 VOLUME

Controls the output level of all audio channels. This does not affect the REC OUT level.

14 SPEAKERS A/B

Turns on or off the set of front speakers connected to the A and/or B terminals on the rear panel each time the corresponding button is pressed.

15 PHONES jack

Outputs audio signals for private listening with headphones. When you connect headphones, no signals are output to the OUTPUT jacks or to the speakers.

16 OPTIMIZER MIC jack

Use to connect and input audio signals from the supplied microphone for the AUTO SETUP function (see page 31).

17 REC OUT/ZONE 2

Selects the source you want to direct to the audio/video recorder and ZONE 2 outputs independently of the source you are listening to or watching in the main room. When set to the SOURCE/REMOTE position, the input source is directed to all outputs. The source in Zone 2 and the source you record are always identical.

18 VIDEO AUX jacks

Inputs audio and video signals from a portable external source such as a game console. To reproduce source signals from these jacks, select V-AUX as the input source.

Opening and closing the front panel door

When you want to use the controls behind the front panel door, open the door by gently pressing on the lower part of the panel. Keep the door closed when not using these controls.

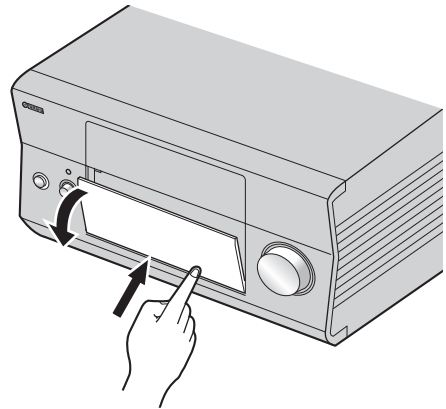

To open, press gently on the lower part of the panel.

Remote control

This section describes the functions of each control on the remote control. See “REMOTE CONTROL FEATURES” on page 80 to operate other components with this remote control.

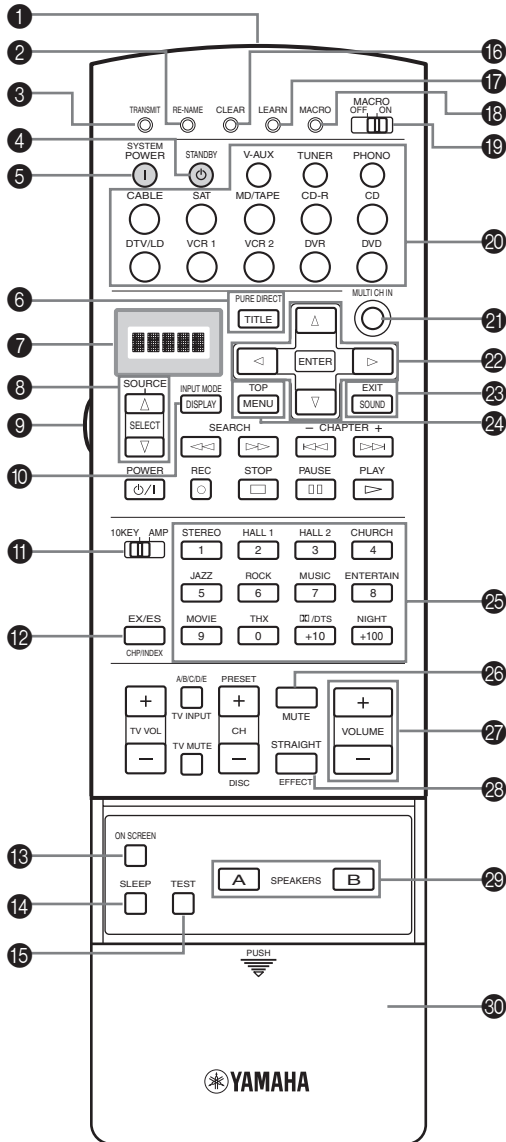

1 Infrared window

Outputs infrared control signals. Aim this window at the component you want to operate.

2 RE-NAME

Used for changing the input source name in the display window (see page 83).

3 TRANSMIT indicator

Flashes while the remote control is sending signals.

4 STANDBY

Sets this unit in the standby mode.

5 SYSTEM POWER

Turns on this unit's power.

6 PURE DIRECT

Turns on or off the 2-channel/multi-channel PURE DIRECT mode (see page 43).

7 Display window

Shows the name of the selected source component that you can control.

8 SOURCE SELECT Δ/∇

Selects another component that you can control independently of the input component selected with the input selector buttons.

9 LIGHT

Press to momentarily light up the display window and buttons on this remote control.

10 INPUT MODE

Sets the priority for the type of input signal (AUTO, i.LINK, DTS, DIGITAL, D.D.RF, ANALOG) received when one component is connected to two or more input jacks on this unit (see page 44).

11 10KEY/AMP

Slide to 10KEY to select a numeric button or operate the component selected using the input selector buttons. Slide to AMP to operate this unit.

12 EX/ES

Switches between 5.1- and 6.1/7.1-channel playback of multi-channel software.

13 ON SCREEN

Selects the GUI display mode for your video monitor.

14 SLEEP

Sets the sleep timer.

15 TEST

Outputs the test tone to adjust the speaker levels.

16 CLEAR

Used for clearing functions acquired when using the learn and rename features and setting manufacturer codes (see page 86).

17 LEARN

Used for setting up the manufacturer code or for programming the functions of other remote controls (see pages 81 and 82).

18 MACRO

Used to program a series of operations for control by a single button (see page 84).

19 MACRO ON/OFF

Turns the macro function on and off.

20 Input selector buttons

Selects the input source and changes the control area.

21 MULTI CH IN

Selects the source connected to the MULTI CH INPUT jacks. This source takes priority over the source selected with INPUT SELECTOR (or the input selector buttons on the remote control).

22 Operation buttons

Operate various parameters and commands shown in the on-screen display.

23 EXIT

Press to exit the on-screen display menus.

24 TOP

Press to display the top level of the on-screen display menus.

25 Sound field program

Use to select sound field programs.

26 MUTE

Mutes the sound. The MUTE indicator turns on when the MUTE function is on. Press again to restore the audio output to the previous volume level.

27 VOLUME +/-

Increases or decreases the volume level.

28 STRAIGHT/EFFECT

Switches the sound fields off or on. When STRAIGHT is selected, input signals (2-channel or multi-channel) are output directly from their respective speakers without effect processing.

29 SPEAKERS A/B

Turn on or off the set of front speakers connected to the A and/or B terminals on the rear panel each time the corresponding button is pressed.

30 Cover

Slide down to use the concealed buttons for various setup and parameter operations.

GUI remote control

This section describes the controls and functions of the GUI remote control. See “USING THE GUI REMOTE CONTROL” on page 29 for details.

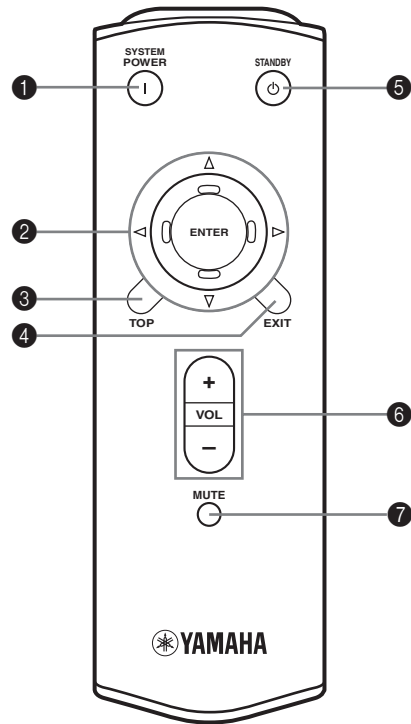

1 SYSTEM POWER

Turns on this unit’s power.

2 Multi-control/ENTER

Tilt up/down or left/right to navigate through the various parameters and commands shown in the on-screen display. Press to choose the selected item in the on-screen display.

3 TOP

Press to display the top level of the on-screen display menus.

4 EXIT

Press to exit the on-screen display menus.

5 STANDBY

Sets this unit in the standby mode.

6 VOLUME +/-

Increases or decreases the volume level.

7 MUTE

Mutes the sound. The MUTE indicator turns on when the MUTE function is on. Press again to restore the audio output to the previous volume level.

Using the remote controls

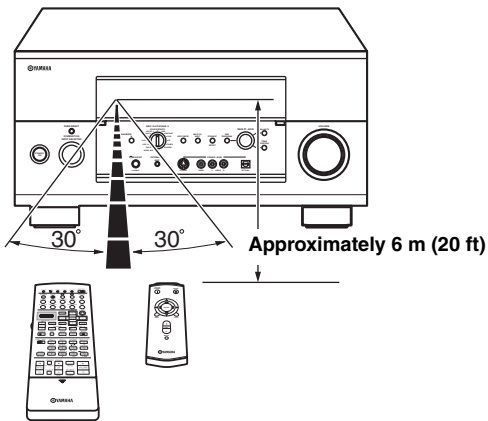

The remote controls transmit directional infrared beams. Be sure to aim the remote controls directly at the remote control sensor on the main unit during operation.

■ Handling the remote controls

- Do not spill water or other liquids on the remote controls.
- Do not drop the remote controls.
- Do not leave or store the remote controls in the following types of conditions:
 - high humidity such as near a bath
 - high temperature such as near a heater or stove
 - extremely low temperatures
 - dusty locations

Front panel display

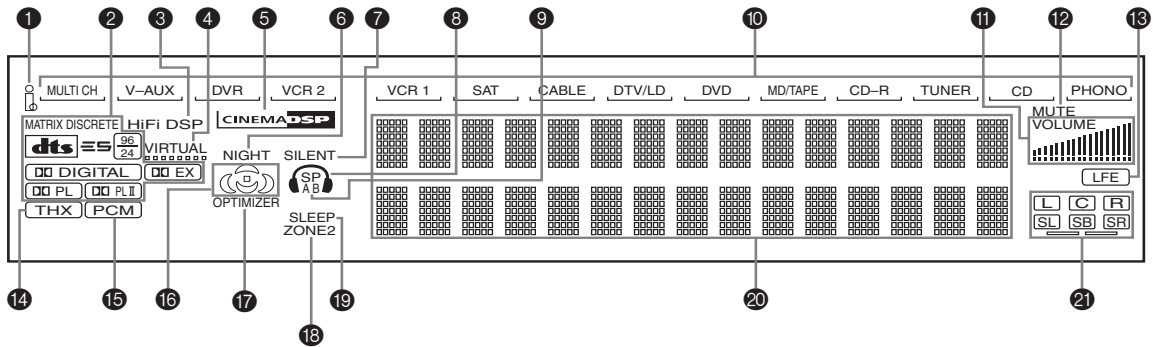

1 i.LINK indicator

Lights up when this unit is playing back i.LINK signals.

2 Decoder indicators

When any of this unit's decoders function, the respective indicator lights up.

3 HiFi DSP

Lights up when you select a HiFi DSP sound field program.

4 VIRTUAL indicator

Lights up when Virtual CINEMA DSP is active (see page 42).

5 CINEMA DSP indicator

Lights up when you select a CINEMA DSP sound field program.

6 NIGHT indicator

Lights up when you select the night listening mode.

7 SILENT CINEMA indicator

Lights up when headphones are connected and a sound field program selected (see page 38).

8 Headphones indicator

Lights up when headphones are connected.

9 SP A B indicators

Lights up according to the set of front speakers selected. Both indicators light up when both sets of speakers are selected, or when bi-wiring.

10 Input source indicators

A cursor lights to show the current input source.

11 VOLUME level indicators

Indicates the volume level.

12 MUTE indicator

Lights up when the MUTE function is on.

13 LFE indicator

Lights up when the input signal contains the LFE signal.

14 THX indicators

Lights up when a THX program is selected.

15 PCM indicator

Lights up when this unit is reproducing PCM (pulse code modulation) digital audio signals.

16 Sound field indicators

Lights to indicate the active DSP sound fields.

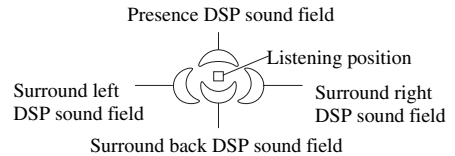

17 OPTIMIZER indicator

Lights up during the auto setup procedure and when the auto setup speaker settings are used without any modifications.

18 ZONE 2 indicator

Lights up when Zone 2 power is on.

19 SLEEP indicator

Lights up when the sleep timer is on.

20 Multi-information display

Shows the current sound field program name and other information when adjusting or changing settings.

21 Input channel indicators

Indicates the channel component of the current digital input signal.

Rear panel

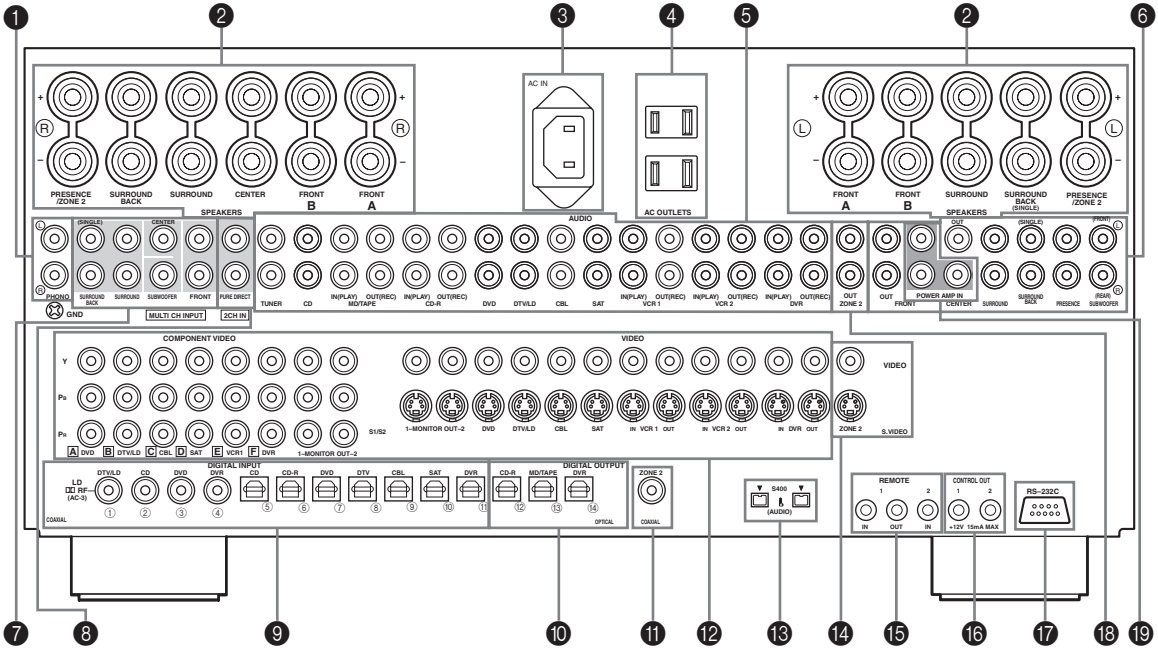

- 1 PHONO**
See page 24 for connection information.
 - 2 Speaker terminals**
See page 14 for connection information.
 - 3 AC INLET**
Use this inlet to plug in the supplied power cable (see page 27).
 - 4 AC OUTLET(S)**
Use to supply power to your other A/V components (see page 27).
 - 5 Audio component jacks**
See pages 24 and 25 for connection information.
 - 6 Pre out jacks**
See page 26 for connection information.
 - 7 MULTI CH INPUT jacks**
See page 18 for connection information.
 - 8 2CH IN jacks**
See page 18 for connection information.
 - 9 DIGITAL INPUT jacks**
See pages 17, 19-21 and 23-25 for details.
 - 10 DIGITAL OUTPUT jacks**
See pages 23 and 25 for details.
 - 11 ZONE 2 COAXIAL OUT**
See page 93 for details.
 - 12 Video component jacks**
See pages 17 and 19-23 for connection information.
 - 13 i.LINK connectors**
See pages 26 and 96 for connection information.
 - 14 ZONE 2 video jacks**
See page 93 for details.
 - 15 REMOTE IN/OUT jacks**
See page 93 for details.
 - 16 CONTROL OUT jacks**
These are control expansion terminals for commercial use.
 - 17 RS-232C terminal**
This is a control expansion terminal for commercial use. Consult your dealer for details.
 - 18 ZONE 2 audio jacks**
See page 93 for details.
 - 19 FRONT IN/CENTER IN**
See page 26 for connection information.
- < General models only >
- VOLTAGE SELECTOR**
See page 27 for details.

SPEAKER SETUP

Speaker placement

Since CINEMA DSP and THX are different surround post-processing technologies, we recommend the following speaker setup in order to enjoy the best surround sound of each technology.

■ CINEMA DSP speaker layout

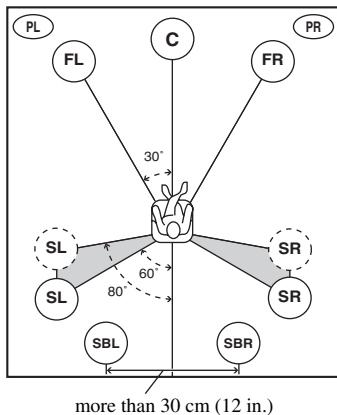

The speaker layout above shows the standard ITU-R speaker setup. You can use it to enjoy CINEMA DSP, multi-channel audio sources and THX.

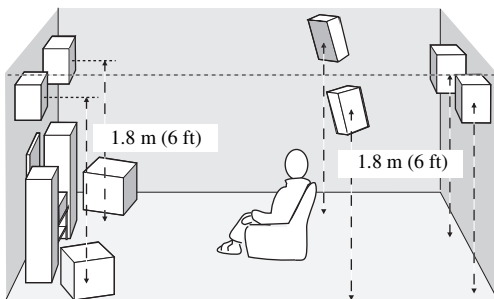

Front speakers (FR and FL)

The front speakers are used for the main source sound. Place these speakers an equal distance from the ideal listening position. The distance of each speaker from each side of the video monitor should be the same.

Center speaker (C)

The center speaker is for the center channel sounds (dialog, vocals, etc.). Align the front face of the center speaker with the front face of your video monitor. Place the speaker centrally between the front speakers and as close to the monitor as possible, such as directly over or under it.

Surround speakers (SR and SL)

The surround speakers are used for effect and surround sounds. Place these speakers behind your listening position, facing slightly inwards, about 1.8 m (6 ft) above the floor.

Surround back speakers (SBR and SBL)

The surround back speakers supplement the surround speakers and provide for more realistic front-to-back transitions. Place these speakers directly behind the listening position and at the same height as the surround speakers. They should be positioned at least 30 cm (12 in.) apart. Ideally, they should be positioned at the same width as the front speakers.

Subwoofer

The use of a subwoofer, such as the YAMAHA Active Servo Processing Subwoofer System, is effective not only for reinforcing bass frequencies from any or all channels, but also for high fidelity reproduction of the LFE (low-frequency effect) channel included in Dolby Digital and DTS software. The position of the subwoofer is not so critical, because low bass sounds are not highly directional. But it is better to place the subwoofer near the front speakers. Turn it slightly toward the center of the room to reduce wall reflections.

Presence speakers (PR and PL)

Presence speakers supplement the sound from the front speakers with extra ambient effects produced by CINEMA DSP (see page 38). These effects include sounds that filmmakers intend to locate a little farther back behind the screen in order to create more theater-like ambience. Place these speakers at the front of the room about 0.5 - 1 m (1 - 3 ft) outside the front speakers, facing slightly inwards, and about 1.8 m (6 ft) above the floor.

Di-pole speaker layout

Either di-pole or direct radiating speaker types can be used for THX surround. If you choose di-pole speakers, please place the surround and surround back speakers according to the speaker layout below.

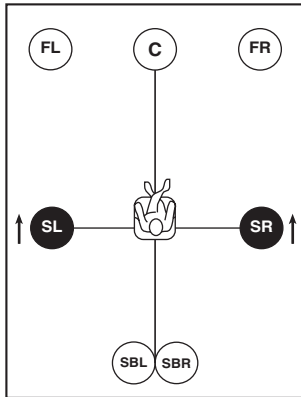

● : Di-pole speaker
 ↑ : Direction of di-pole speaker

Speaker connections

Be sure to connect the left channel (L), right channel (R), “+” (red) and “-” (black) properly. If the connections are faulty, no sound can be heard from the speakers, and if the polarity of the speaker connections is incorrect, the sound will be unnatural and lack bass.

CAUTION

- If you intend to use 6-ohm speakers, be sure to set this unit’s speaker impedance setting to 6 ohms before using (see page 28).
- Before connecting the speakers, make sure that this unit’s power is off.
- Do not let the bare speaker wires touch each other or any metal part of this unit. This could damage this unit and/or the speakers.
- Use magnetically shielded speakers. If this type of speaker still creates interference with the monitor, place the speakers away from the monitor.

A speaker cord is actually a pair of insulated cables running side by side. One cable is colored or shaped differently, perhaps with a stripe, groove or ridges. Connect the striped (grooved, etc.) cable to the “+” (red) terminals on this unit and your speaker. Connect the plain cable to the “-” (black) terminals.

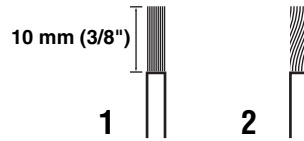

- 1 Remove approximately 10 mm (3/8") of insulation from each of the speaker cables.
- 2 Twist the exposed wires of the cable together to prevent short circuits.
- 3 Unscrew the knob.
 - ☛ The supplied speaker terminal wrench is useful for screwing or unscrewing knobs.
- 4 Insert one bare wire into the hole in the side of each terminal.
- 5 Tighten the knob to secure the wire.

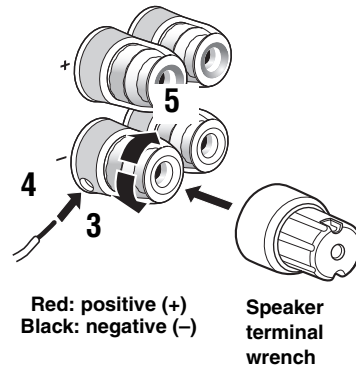

Banana plug connections

(With the exception of U.K. and Europe models)
 First, tighten the knob and then insert the banana plug connector into the end of the corresponding terminal.

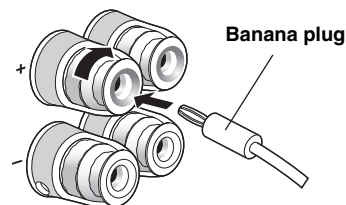

(With the exception of U.K. and Europe models)

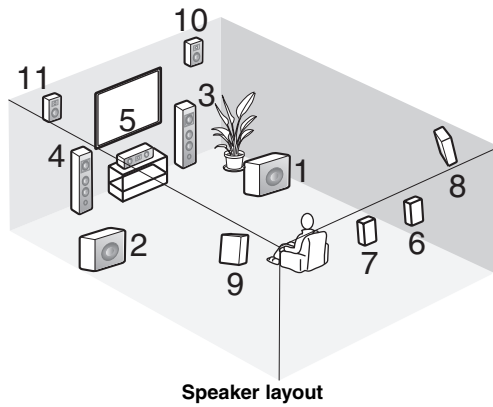
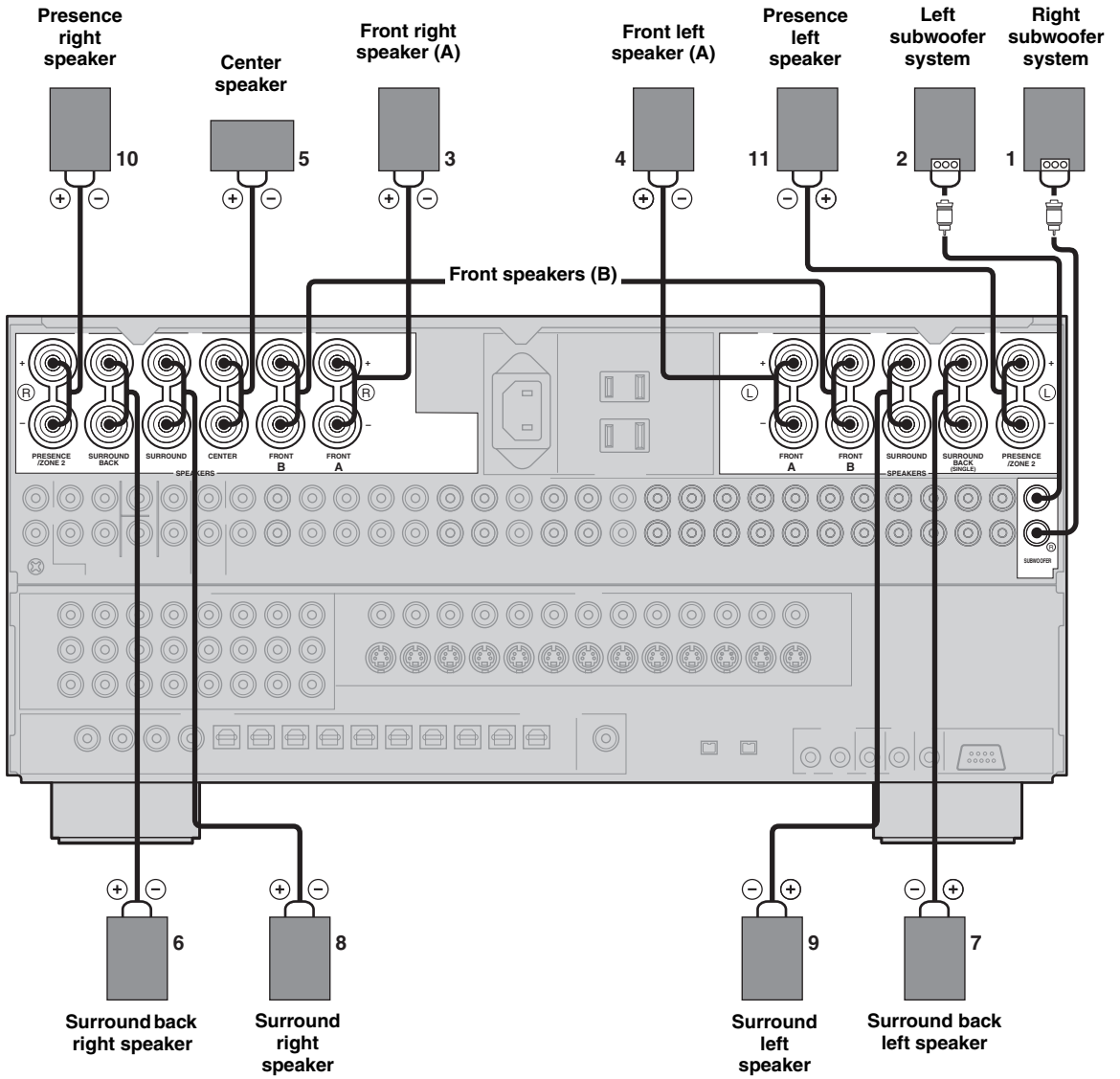

■ FRONT terminals

Connect one or two speaker systems to these terminals. If you use only one speaker system, connect it to either of the FRONT A or B terminals.

Note

The Canada model cannot output to two separate speaker systems simultaneously.

■ Bi-wired connection

The unit also allows you to make bi-wired connections to one speaker system. Use two pairs of speaker cables for each speaker (one pair for the woofer and one pair for the tweeter/mid-range). To use the bi-wired connections, press SPEAKERS A and SPEAKERS B on the front panel so that both SP A and B light up on the front panel display.

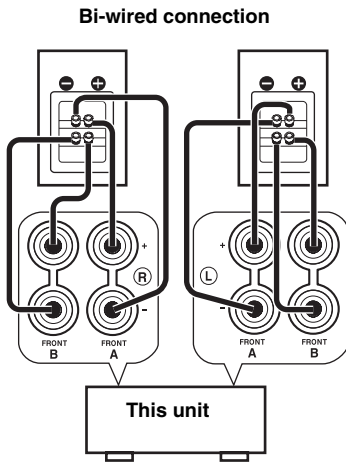

■ CENTER terminals

Connect a center speaker to these terminals.

■ SURROUND terminals

Connect a surround speaker system to these terminals.

■ SUBWOOFER jacks

Connect one or two subwoofer(s) with built-in amplifier, such as the YAMAHA Active Servo Processing Subwoofer System, to the jack(s).

■ SURROUND BACK terminals

Connect a surround back speaker system to these terminals. If you only connect one surround back speaker, connect it to the left (L) terminals.

■ PRESENCE/ZONE 2 terminals

Connect presence speakers to these terminals. You can also use these terminals for connecting Zone 2 speakers (see page 94).

Note

The presence speakers output ambient effects created by the DSP sound fields. They do not output sound when other sound fields are selected.

CONNECTIONS

Connecting components

CAUTION

Do not connect this unit or other components to the mains power until all connections between components are completed.

Signal directions and cable indications

audio signal direction 

video signal direction 

For analog signals

left analog cables 

right analog cables 

For digital signals

optical cables 

coaxial cables 

For video signals

video cables 

S video cables 

Analog jacks

You can input analog signals from audio components by connecting an audio pin cable to each of this unit's analog jacks. Connect red plugs to the right jacks and white plugs to the left jacks.

Digital jacks

This unit has digital jacks for direct transmission of digital signals through either coaxial or fiber optic cables. You can use the digital jacks to input PCM, Dolby Digital and DTS bitstreams. When you connect components to both the COAXIAL and OPTICAL jacks, priority is given to the input signals from the COAXIAL jack. COAXIAL jacks are compatible with digital signals with sampling frequencies up to 192 kHz, and OPTICAL jacks with sampling frequencies up to 96 kHz.

Note

This unit handles digital and analog signals independently. Thus, audio signals input to the analog jacks are only output to the analog OUT (REC) jacks. Likewise audio signals input to the digital (OPTICAL or COAXIAL) jacks are only output to the DIGITAL OUTPUT jacks.

i.LINK jacks

This unit can be connected with i.LINK equipped components using 4-pin, S400 i.LINK cables. This connection enables you to send and receive digital audio at high speed and with high fidelity.

Video jacks

This unit has three types of video jacks. The signals input through any type of VIDEO IN jack can be output through any of the VIDEO (MONITOR OUT) jacks (automatic video conversion).



VIDEO jack

For conventional composite video signals.

S VIDEO jack

For S video signals, separated into luminance (Y) and color (C) video signals to achieve high-quality color reproduction.

COMPONENT VIDEO jacks

For component signals, separated into luminance (Y) and color difference (Pb, Pr) to provide the best quality in picture reproduction.

Notes

- When signals are input simultaneously through the COMPONENT VIDEO, S VIDEO and VIDEO jacks, the input priority is as follows: COMPONENT VIDEO, S VIDEO then VIDEO.
- Video signal conversion is only possible for signals input through the COMPONENT VIDEO jack when Resolution is set to 480i/576i. Signals will not be converted when Resolution is set to 480p/576p, 720p or 1080i (see page 72).

Connecting video components

■ Connections for DVD playback

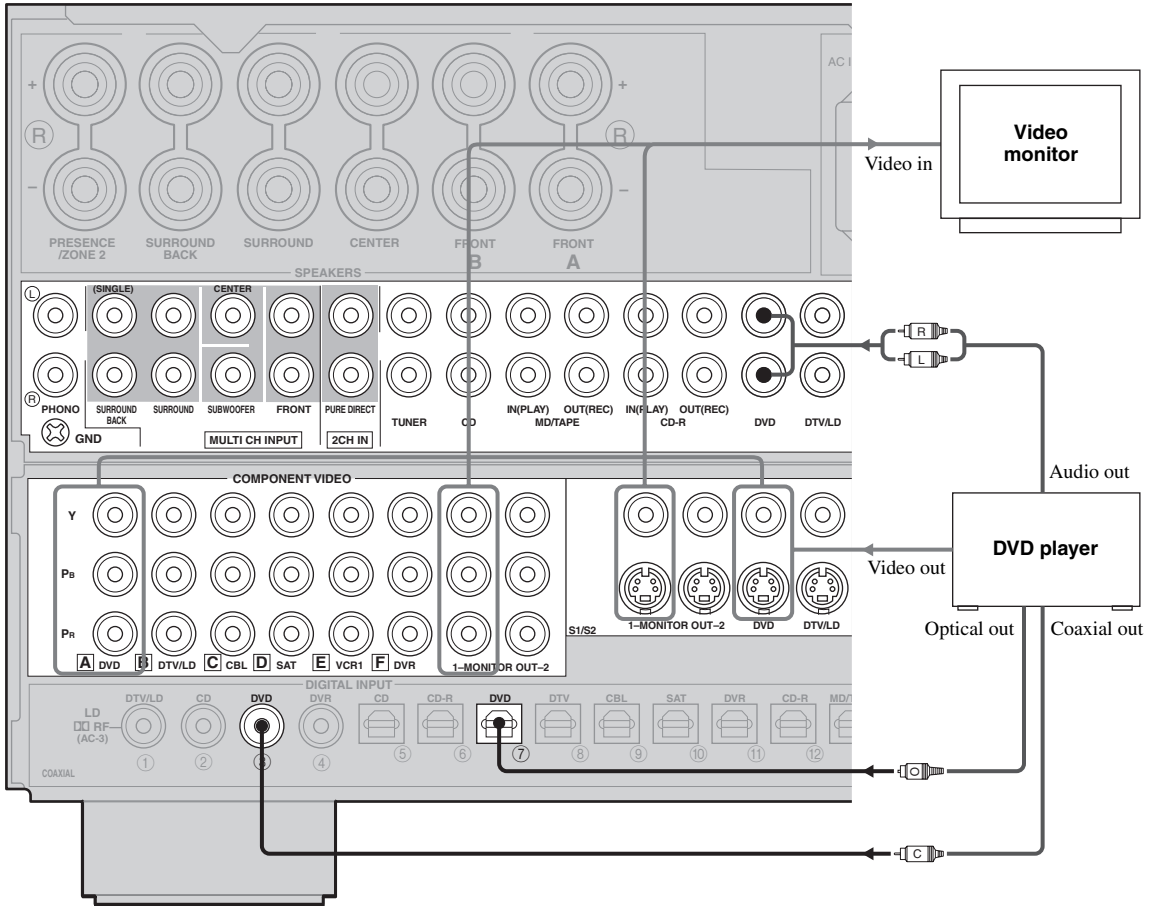

PREPARATION

English

■ **Connecting to the MULTI CH INPUT jacks**

This unit is equipped with 8 additional input jacks (left and right FRONT, CENTER, left and right SURROUND, left and right SURROUND BACK and SUBWOOFER) for discrete multi-channel input from a universal disc player, external decoder, sound processor or pre-amplifier.

Connect the output jacks on your multi-disc player or external decoder to the MULTI CH INPUT jacks. Be sure to match the left and right outputs to the left and right input jacks for the front and surround channels.

For multi-channel input

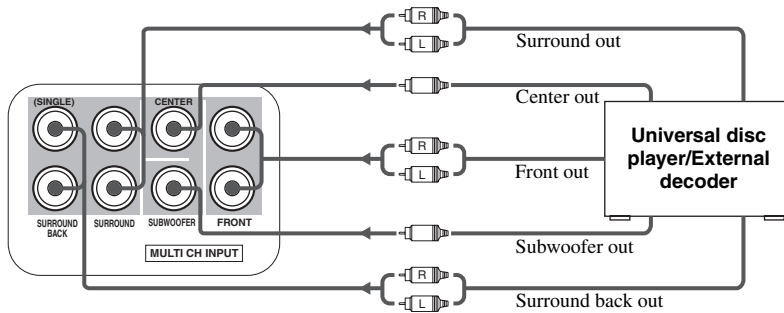

■ **Connecting to the 2CH IN jacks**

This unit is equipped with 2 additional input jacks for discrete 2-channel input from a universal disc player, passive input selector or other high-speed audio component.

The signals input to these jacks can be chosen by pressing PURE DIRECT (see page 43). This feature provides the best possible sound quality from this unit.

Connect the output jacks on your multi-disc player or external decoder to the 2CH IN jacks.

For 2-channel input

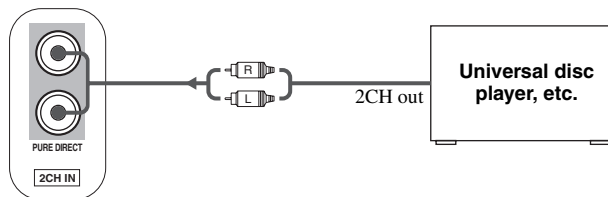

■ Connections for digital TV broadcasts or LD playback

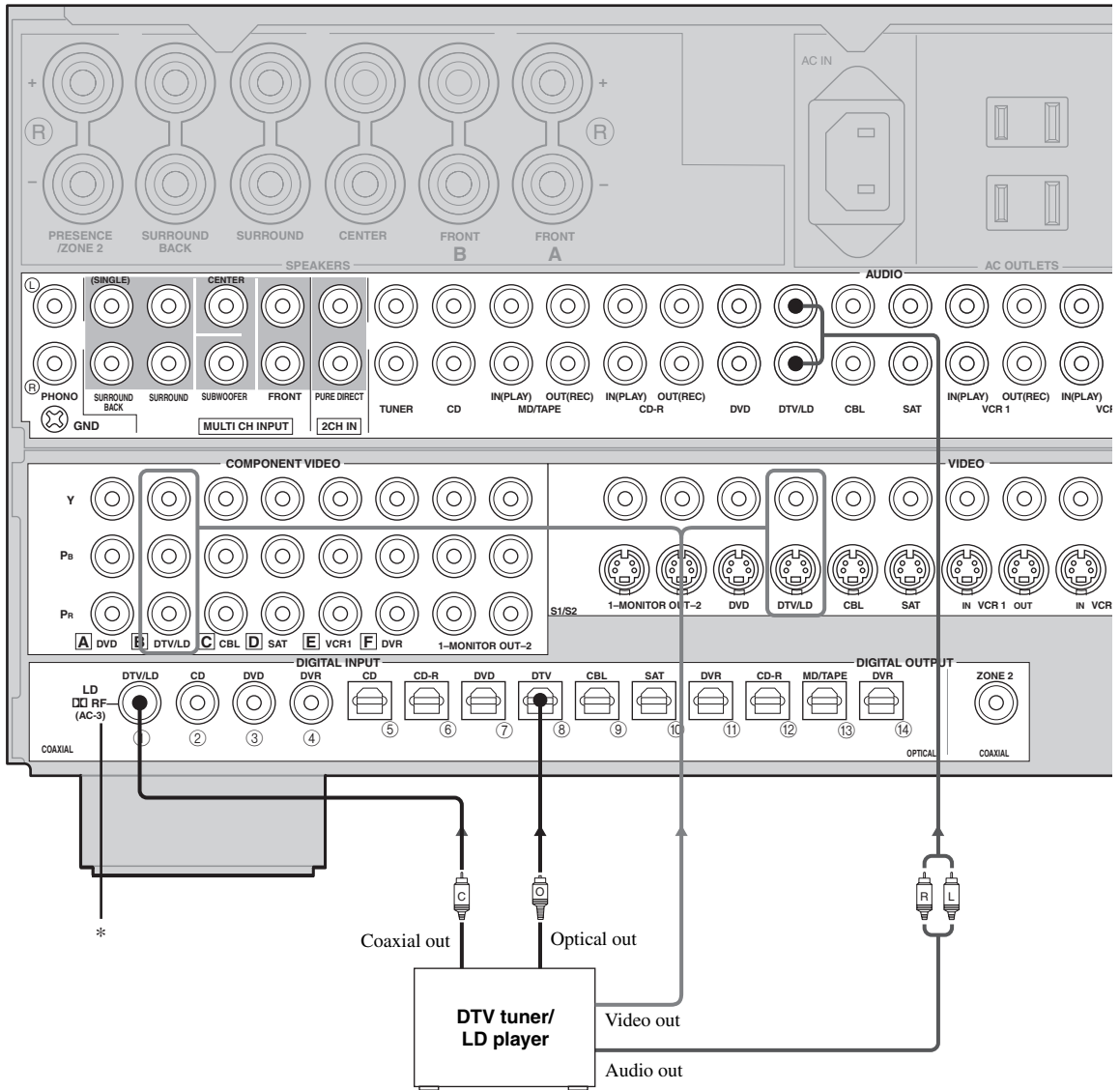

PREPARATION

* A demodulator circuit is built into the Dolby Digital RF input so you can connect it directly to the Dolby Digital RF signal output on your LD player. Make sure you set Coaxial Input to ① LD-RF in the Assign system parameter (page 59).

English

■ Connections for cable TV broadcasts

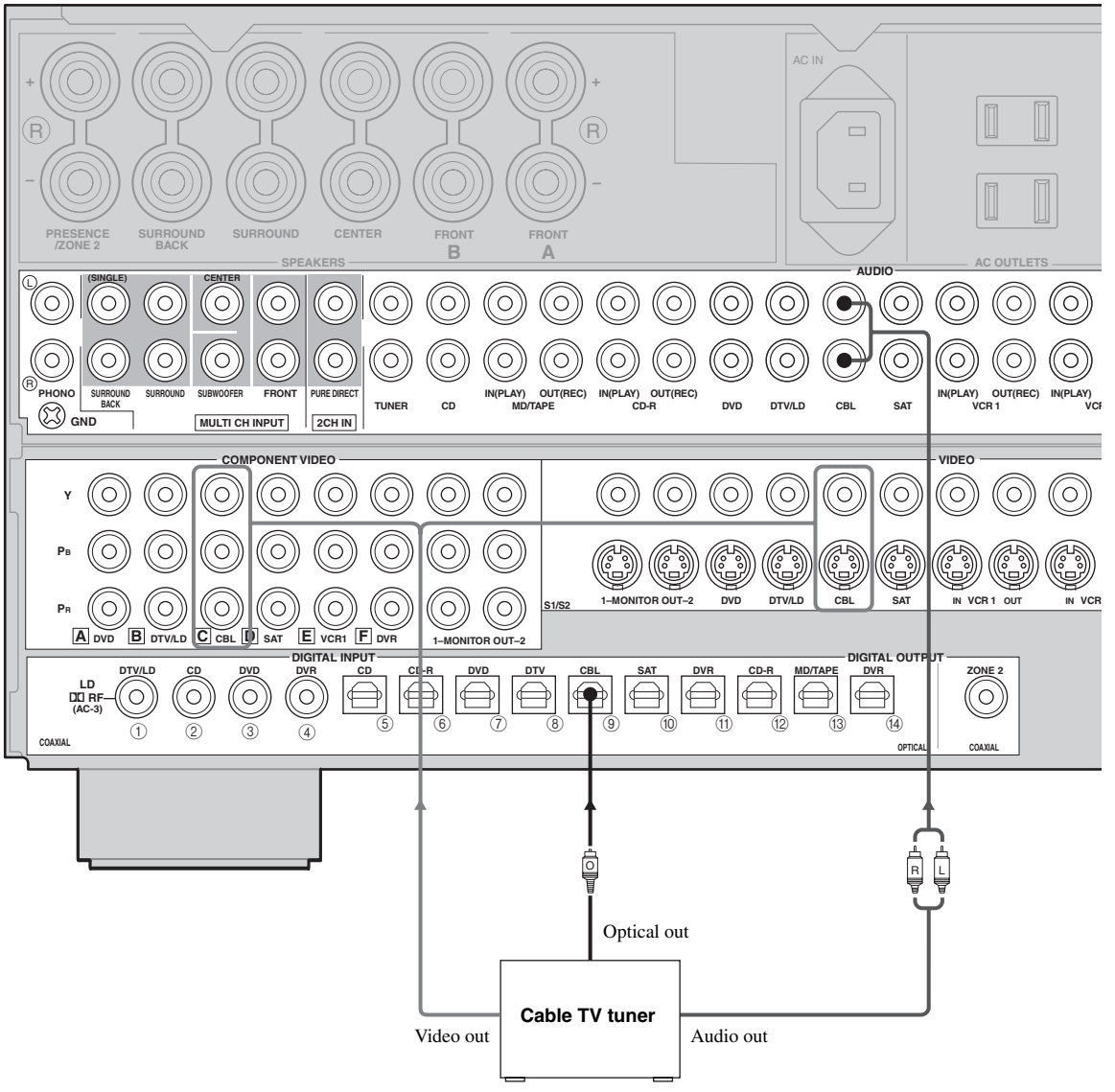

■ Connections for satellite broadcasts

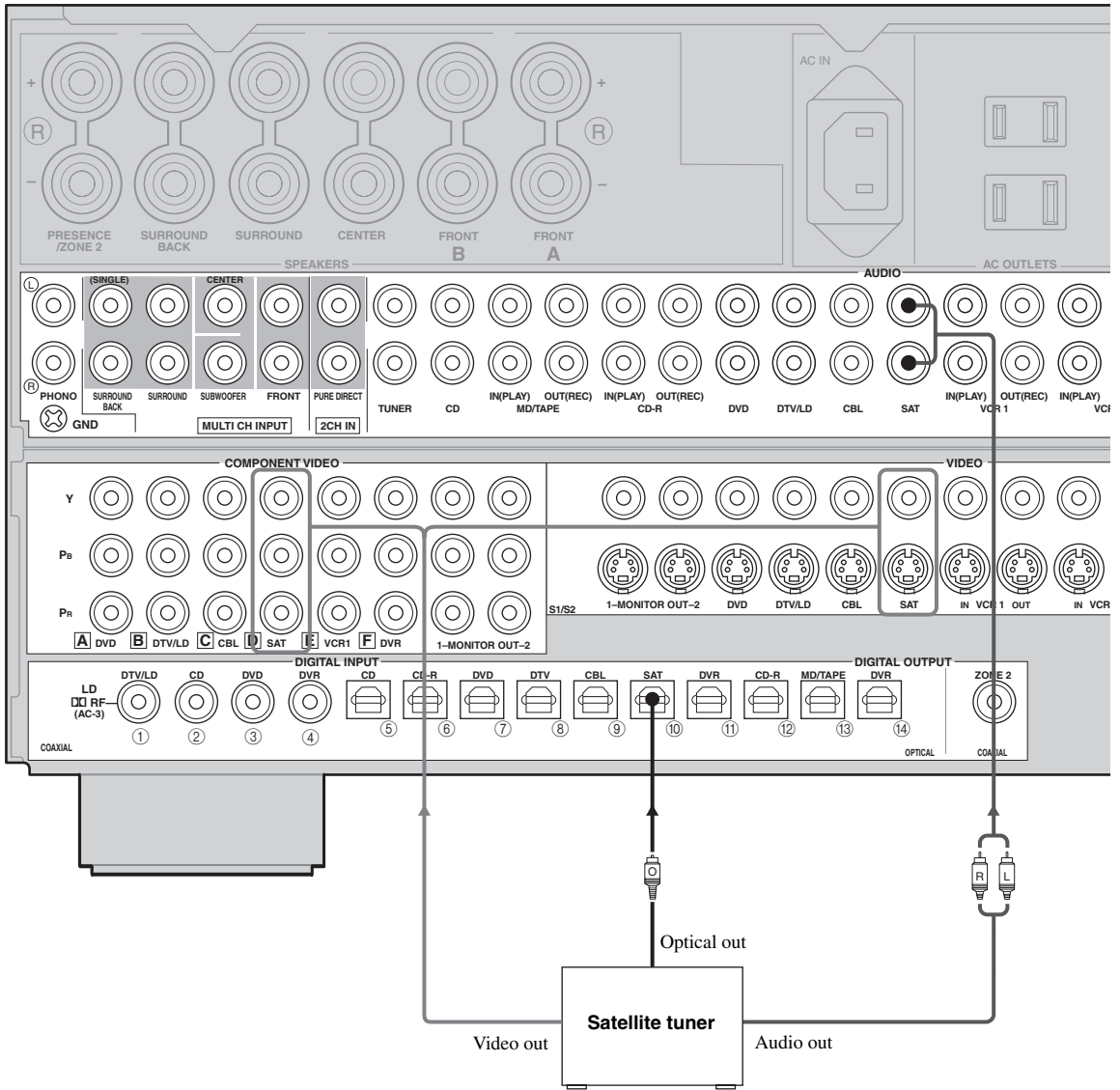

PREPARATION

English

■ Connections for VCR playback and recording

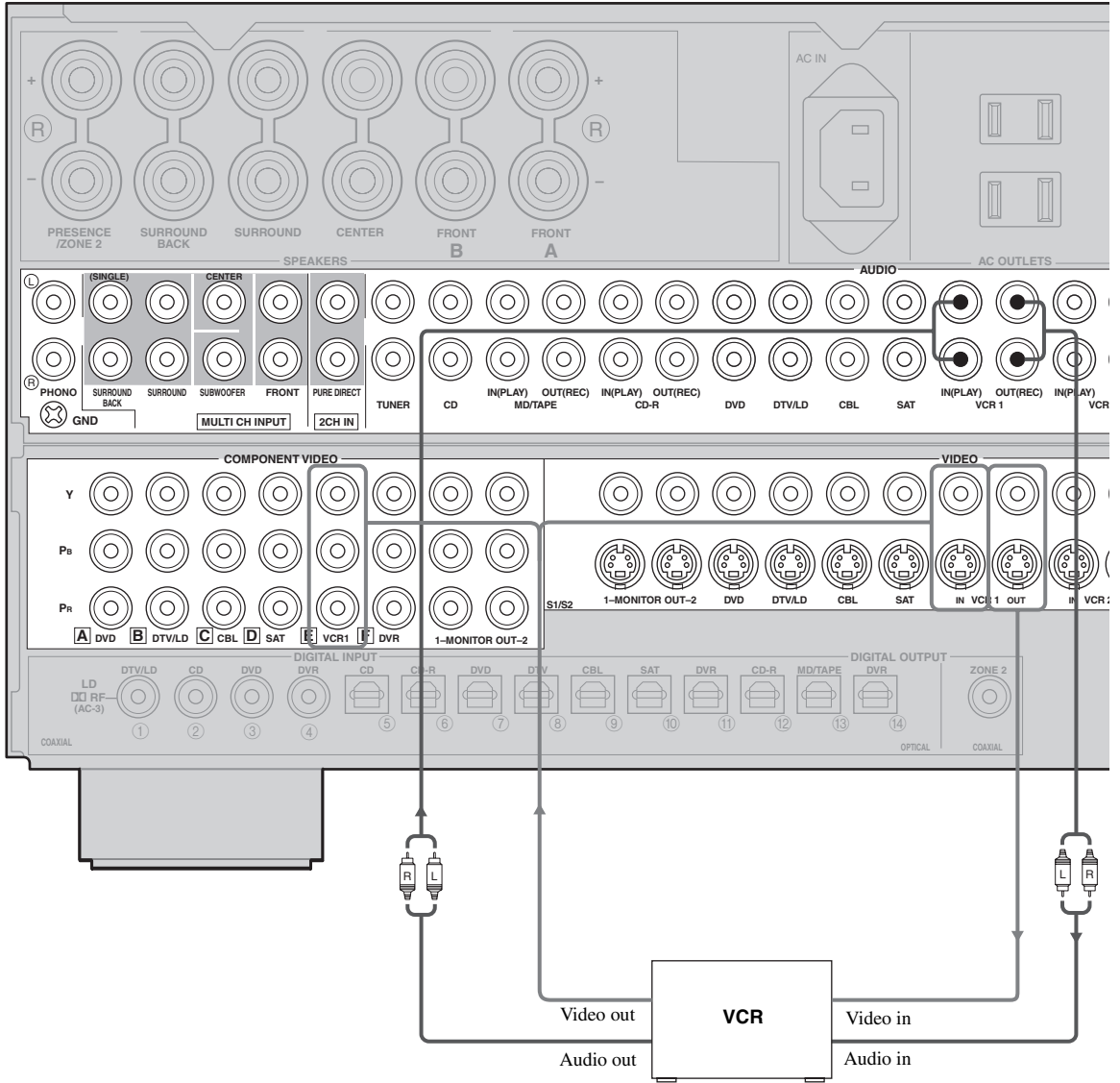

■ Connections to VIDEO AUX jacks (on the front panel)

Use these jacks to connect any video source, such as a game console or video camera, to this unit.

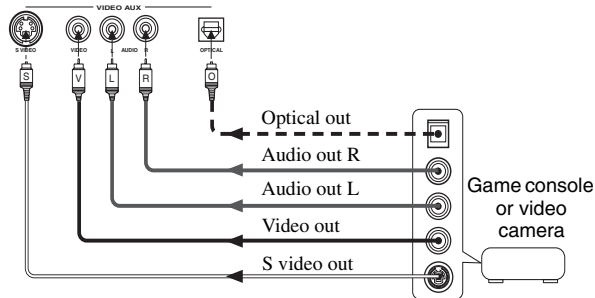

■ Connections for DVD recorder playback and recording

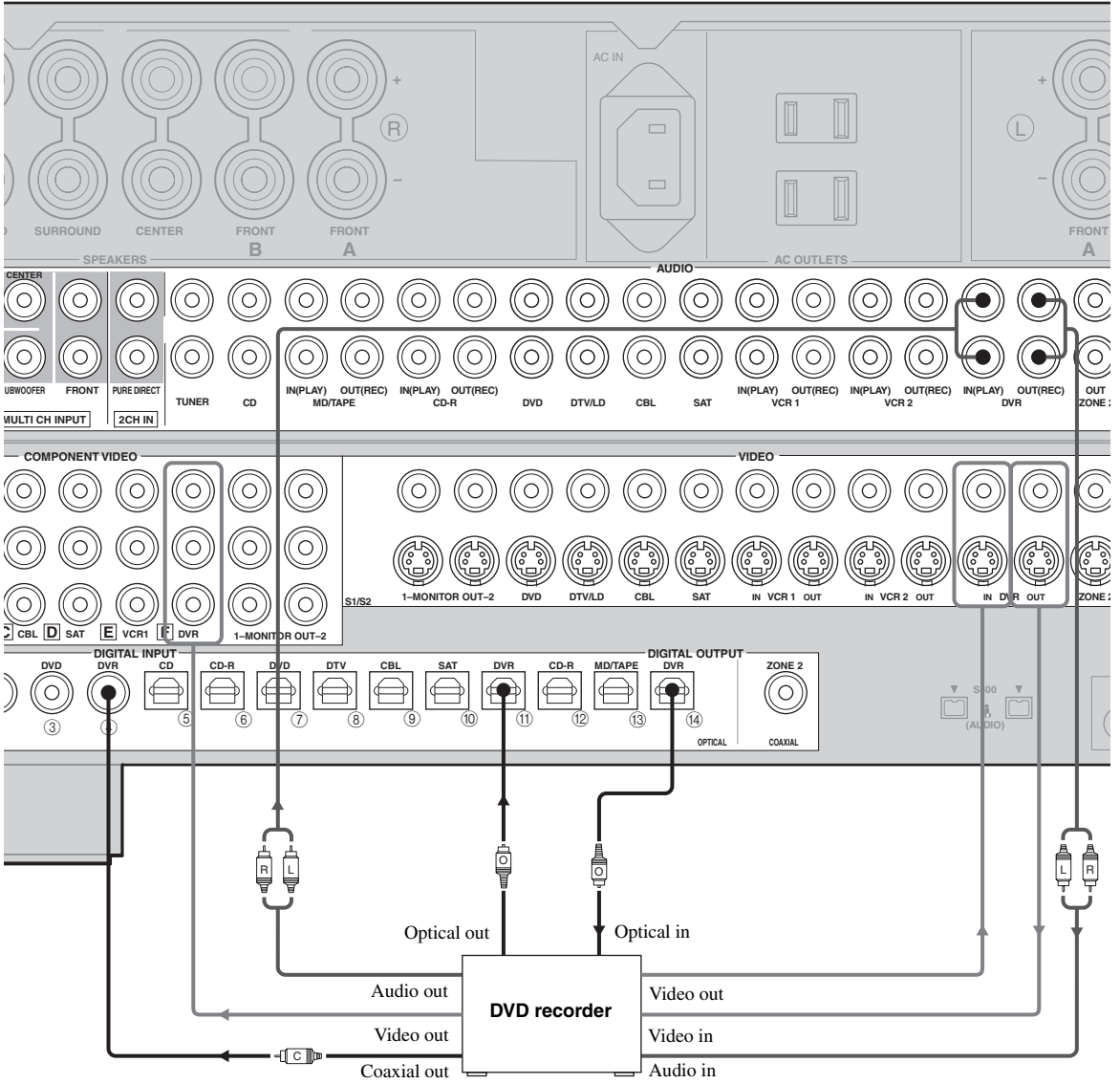

PREPARATION

English

Connecting audio components

■ Connections for audio playback

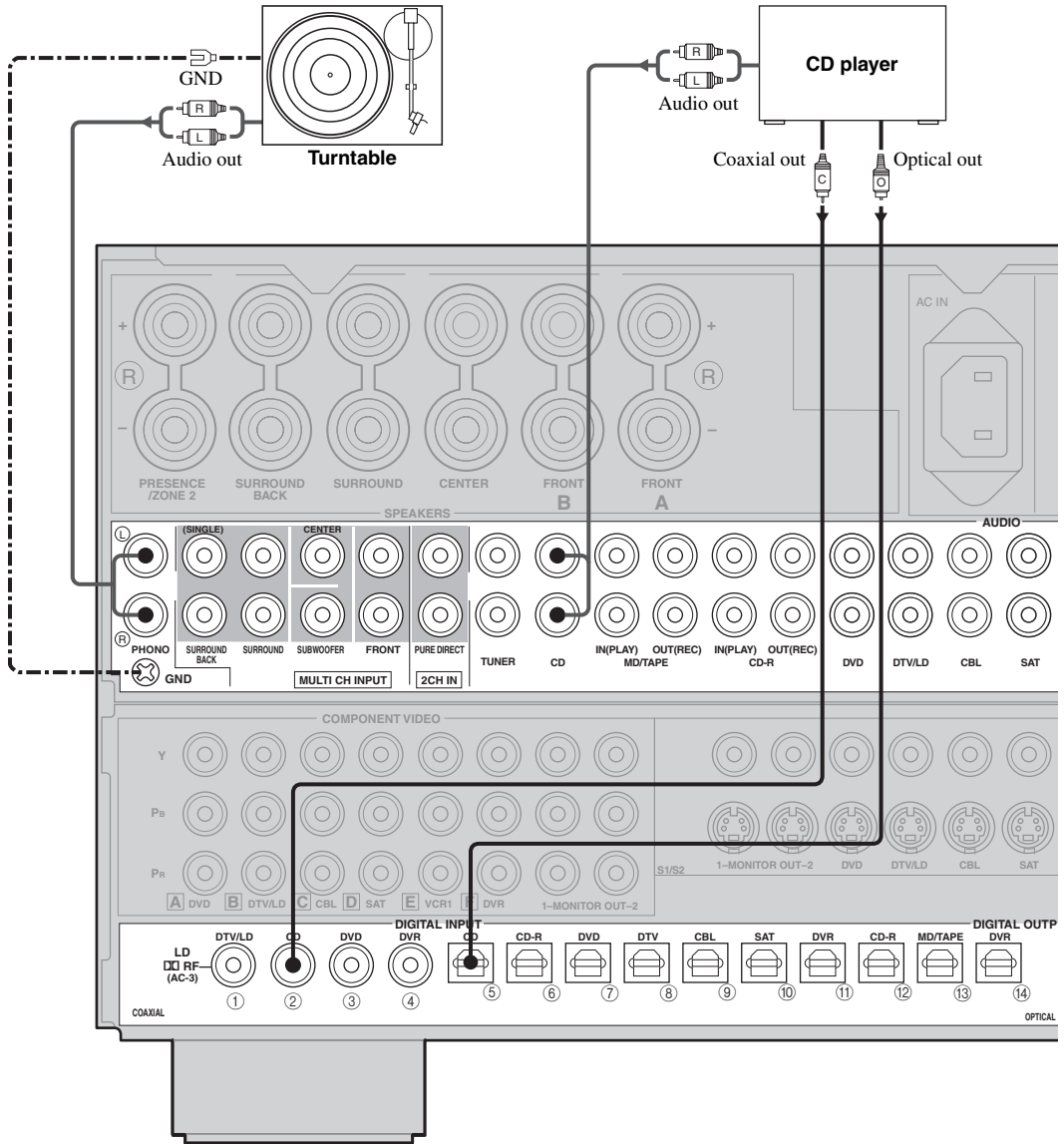

■ Connecting a turntable

PHONO jacks are for connecting a turntable with an MM or high-output MC cartridge. If you have a turntable with a low-output MC cartridge, use an in-line boosting transformer or MC-head amplifier when connecting to these jacks.



Connect your turntable to the GND terminal to reduce noise in the signal. However you may hear less noise by not connecting to the GND terminal with some record players.

■ Connections for audio playback and recording

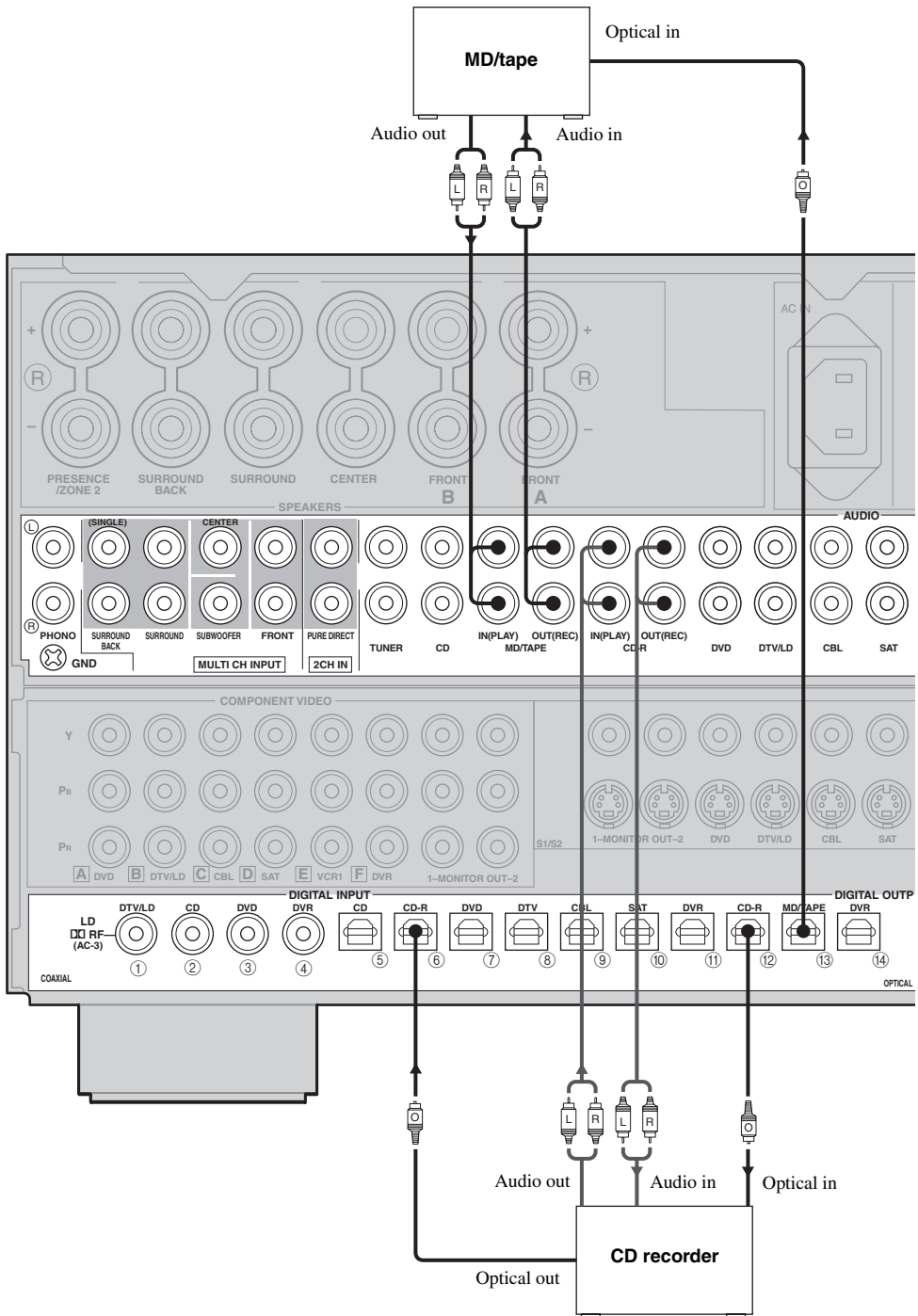

■ Connecting external power amplifiers

If you want to increase the power output to the speakers, or want to use another power amplifier, connect an external amplifier to the pre out jacks.

Notes

- When RCA pin plugs are connected to the pre out jacks for output to an external amplifier, it is not necessary to use the corresponding SPEAKERS terminals. Set the volume of the amplifier connected to this unit to the maximum.
- The signal output through the FRONT OUT, CENTER OUT and SUBWOOFER jacks is affected by the TONE CONTROL settings.
- Signals will only be output from the FRONT OUT jacks if SPEAKERS B is set to “ZONE B” (see page 77) and SPEAKERS A is turned off (see page 77).

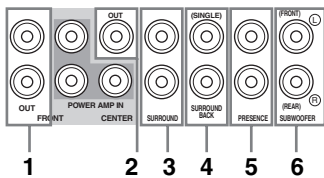

1 FRONT OUT jacks

Front channel line output jacks.

2 CENTER OUT jack

Center channel line output jack.

3 SURROUND jacks

Surround channel line output jacks.

4 SURROUND BACK jacks

Surround back channel line output jacks.

5 PRESENCE jacks

Presence channel line output jacks.

6 SUBWOOFER jacks

Connect one or two subwoofer(s) with built-in amplifier, such as the YAMAHA Active Servo Processing Subwoofer System, to these jacks.

Notes

- Adjust the volume level of the subwoofer with the control on the subwoofer. It is also possible to adjust the volume level using this unit’s remote control (see page 69).
- Some signals may not be output from the SUBWOOFER jack depending on the Speaker Set (see page 67) and LFE Level (see page 63) settings.

■ Connecting external preamplifiers

If you want to input signals from another preamplifier, connect the external preamplifier to the FRONT IN/ CENTER IN jacks.

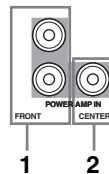

1 FRONT IN jacks

Line input to this unit’s front channel amplifiers. When connecting to these jacks, signals input to this unit’s preamplifier will not be output from the unit’s front amplifier.

2 CENTER IN jack

Line input to this unit’s center channel amplifier. When connecting to this jack, signals input to this unit’s preamplifier will not be output from the unit’s center amplifier.

■ Connecting i.LINK components

If you have a component with an i.LINK connector, you can enjoy digital audio from CD, DVD, Super Audio CD or DVD-A discs.

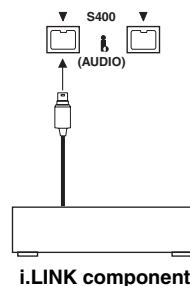

Connecting the power supply cord

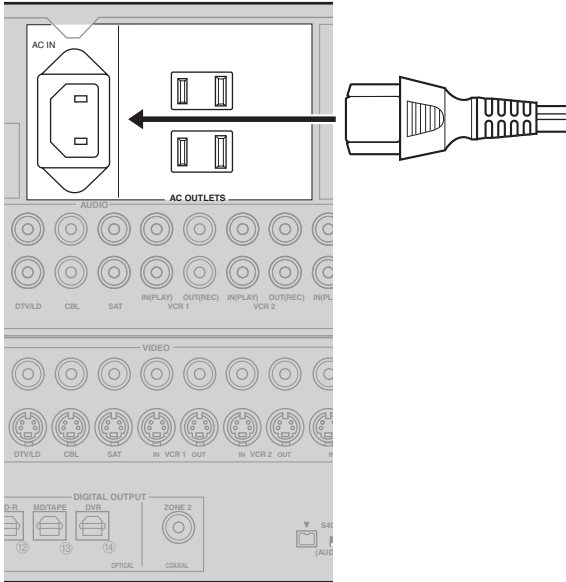

■ Connecting the AC power cord

Plug the power cord into the AC inlet after all other connections are complete, then plug the power cord into an AC wall outlet.

CAUTION

Do not use an AC power cord other than the one provided. Use of other power cords may result in fire or electrical shock.

■ AC OUTLET(S) (SWITCHED)

U.K. and Australia models 1 OUTLET
 Korea model None
 Other models 2 OUTLETS

Use the outlet(s) to connect the power cords from your other components to this unit. Power to the AC OUTLET(S) is turned on and off using STANDBY/ON (or SYSTEM POWER and STANDBY). The outlet(s) supply power to any connected component whenever this unit is turned on. The maximum power (total power consumption of components) that can be connected to the AC OUTLET(S) is:

Korea model N/A
 Other models 120 W

■ VOLTAGE SELECTOR (General model only)

The VOLTAGE SELECTOR on the rear panel of this unit must be set to your local main voltage BEFORE plugging into the AC main supply. Voltages are 110/120/220/230-240 V AC and 50/60 Hz.

■ Memory back-up

The memory back-up circuit prevents the stored data from being lost even if this unit is in the standby mode. However, if the power cord is disconnected from the AC wall outlet, or the power supply is cut for more than one week, the stored data will be lost.

VOLTAGE SELECTOR

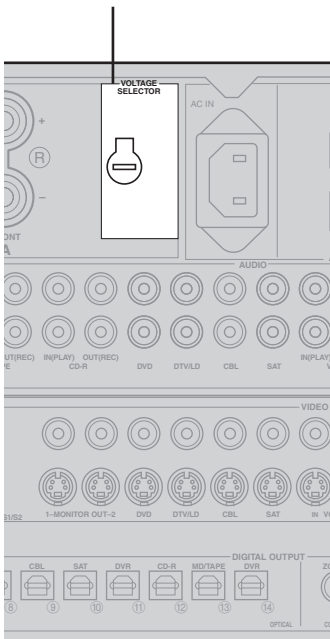

(General model)

Speaker impedance setting

CAUTION

If you are using 6-ohm speakers, set the impedance to 6 ohms as follows before turning on the power.

Be sure this unit is in the standby mode.

- 1 On the front panel, while holding down SPEAKERS A, press STANDBY/ON.**
“SP Imp. Set” appears on the front panel display for a few seconds, then “Minimum 8ohms” appears.

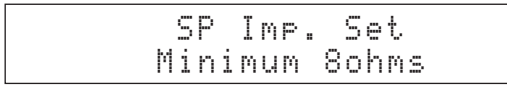

- 2 Press SPEAKERS A or SPEAKERS B to select the impedance of your speakers.**
You can select either 6 ohms or 8 ohms.
- 3 Press STANDBY/ON to exit the setting.**
This unit is set to the standby mode.

Turning on the power

When all connections are complete, turn on this unit's power.

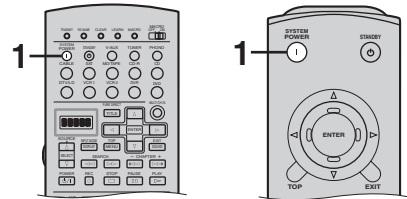
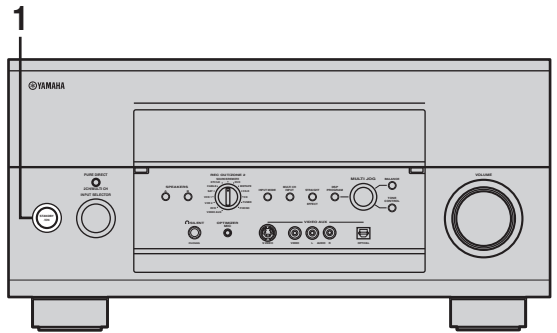

- 1 Press STANDBY/ON (SYSTEM POWER on the remote controls) to turn on this unit's power.**

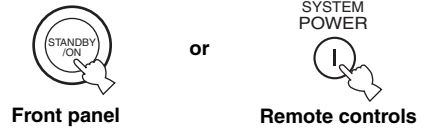

- 2 Turn on the video monitor connected to this unit.**

USING THE GUI REMOTE CONTROL

GUI remote control operations

The GUI (graphical user interface) remote control provides a simple and convenient way to control this unit while viewing a GUI display on your video monitor. You can use the following steps to:

- Configure i.LINK connections
- Select and configure sound field programs
- Select and configure input sources
- Manually configure your system settings
- Automatically set up your system
- Protect your system settings
- Display information about audio and video signals

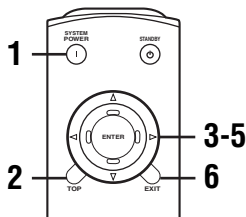

1 Switch on this unit and your video monitor.
Make sure the GUI is displayed.

2 Press TOP.
The TOP display appears.

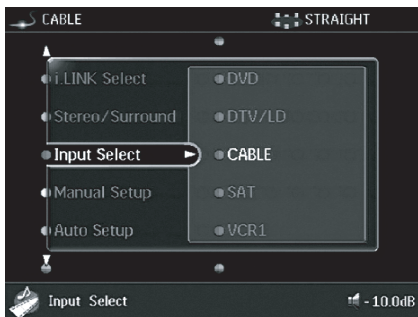

3 Press Δ/∇ repeatedly to select a category (i.e., Manual Setup), then press \triangleright to enter the selected category (i.e., Basic).

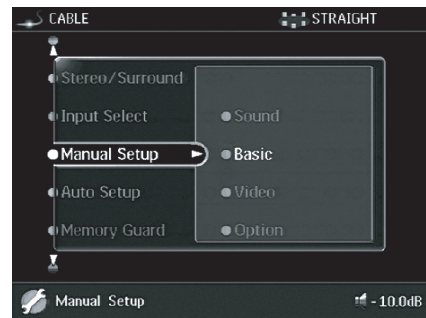
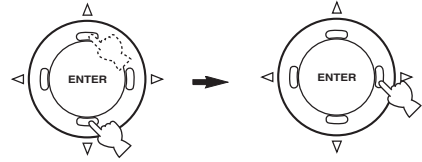

- 4 Use $\Delta/\nabla/\leftarrow/\rightarrow$ to navigate through the categories, menus and parameters.

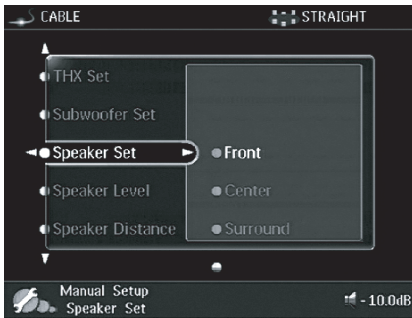

- 5 To select the parameter you want to adjust press ENTER.

- 6 Use $\Delta/\nabla/\leftarrow/\rightarrow$ to adjust the parameters.



For details about each parameter see page 55.

- 7 When finished, press EXIT to exit.

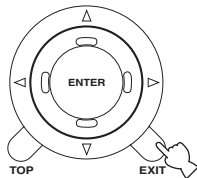

Note

All GUI remote control operations featured in this manual can also be performed using the main remote control. When using the main remote control to perform these operations, make sure that 10KEY/AMP on the remote controller is set to AMP.

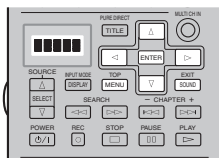

AUTO SETUP

Introduction

This unit employs YAMAHA Parametric Room Acoustic Optimizer (YPAO) technology which lets you avoid troublesome listening-based speaker setup and achieves highly accurate sound adjustments. The supplied optimizer microphone collects and analyzes the sound your speakers produce in your actual listening environment.

Notes

- Please be advised that it is normal for loud test tones to be output during the auto setup procedure.
- If auto setup stops and an error message(s) appear on the GUI display, follow the troubleshooting on page 35.

YPAO performs the following checks and makes appropriate adjustments to give you the best possible sound from your system.

Wiring

Checks the polarity of each speaker.

Distance

Checks the distance of each speaker from the listening position and adjusts the timing of each channel.

Size

Checks the speaker's frequency response and sets the appropriate low frequency crossover for each channel.

Equalizing

Adjusts frequency and levels of each channel's parametric equalizer to reduce coloration across the channels and create a cohesive sound field. This is particularly important if you use different brands or sizes of speakers for some channels or have a room with unique sonic characteristics.

YPAO equalizing calibration incorporates three parameters (Frequency, Level and Q factor) for each of the 10 bands in its parametric equalizer (plus 5 subwoofer bands) to provide highly precise automatic adjustment of frequency characteristics.

Level

Checks and adjusts the sound level (volume) of each speaker.

Optimizer microphone setup

- 1 **Connect the supplied optimizer microphone to the OPTIMIZER MIC jack on the front panel.**

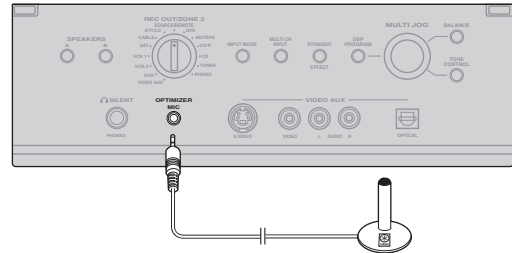

Note

After you have completed the auto setup procedure, be sure to disconnect the optimizer microphone. If it is left connected to this unit, no sound will be output from the speakers.

- 2 **Place the optimizer microphone on a flat level surface with the omni-directional microphone head upward, at your normal listening position.**

* If possible, use a tripod (etc.) to affix the optimizer microphone at the same height as your ears would be when you are seated in your listening position.

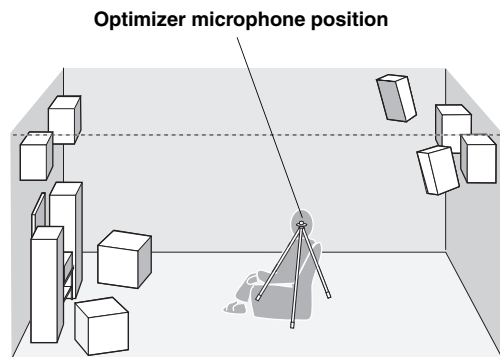

Starting the setup

For best results, make sure the room is as quiet as possible during the auto setup procedure. If there is too much ambient noise, the results may not be satisfactory.



If your subwoofer can adjust the output volume and crossover frequency, set the volume to about half way (or slightly less), and set the crossover frequency to the maximum.

- 1 Switch on the unit and video monitor, then press TOP on the GUI remote control.

The TOP display appears.

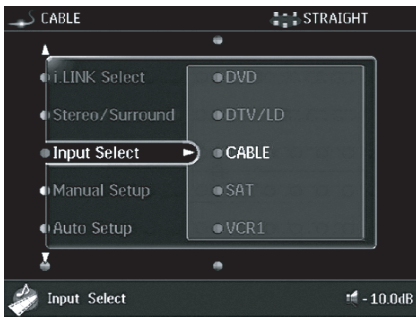
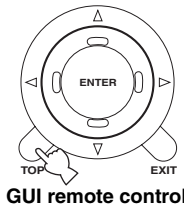

- 2 Press Δ/∇ repeatedly to select Auto Setup, then press \triangleright .

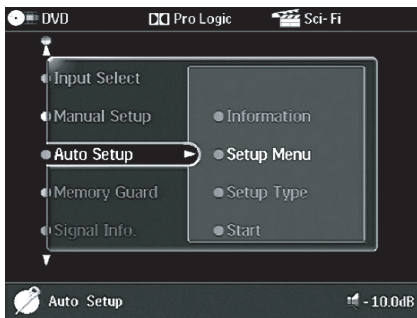
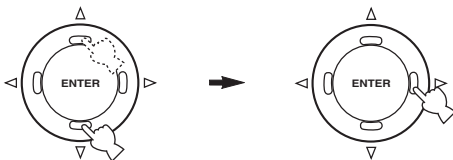

- 3 Press Δ/∇ repeatedly to select Setup Menu, then press \triangleright .



- 4 Press Δ/∇ repeatedly to select Wiring, Distance, Size, Equalizing or Level.



For Wiring, Distance, Size or Level, select:

- Check To automatically check and adjust the selected item.
- Skip To skip the selected item and perform no adjustments.



When using THX speakers, select Skip and make sure that Small or Small x2 is selected in Speaker Set (page 67) and that 80Hz (THX) is selected in Cross Over (page 69).

For Equalizing, select:

- Skip To skip the selected item and perform no adjustments.
- Flat To average the frequency response of all speakers. Recommended if all of your speakers are of similar quality.
- Front To adjust the frequency response of each speaker in accordance with the sound of your front speakers. Recommended if your front speakers are of much higher quality than your other speakers.
- Low To average the frequency response of all speakers, giving priority to the accuracy of bass frequencies.
- Mid To average the frequency response of all speakers, giving priority to the accuracy of mid-range frequencies.
- High To average the frequency response of all speakers, giving priority to the accuracy of high frequencies.

5 Once you have selected the desired setting, press <Left> to move back to Setup Menu.



6 Press <Down> to select Setup Type, then select:

- Auto To automatically perform the entire auto setup procedure.
- Step To pause for confirmation between each check in the auto setup procedure.



7 Press <Down> to select Start, then press ENTER.

Loud test tones are output from each speaker and “Measuring” appears during the auto setup procedure.



- To pause the auto setup procedure, press one of the cursor buttons (Up/Down/Left/Right) or ENTER. In the pause mode, press Up to RETRY the procedure, Left to cancel auto setup, or Down to skip to the next item without completing the current procedure.
- If “E10:Internal Err” appears during testing, restart the procedure from step 3.
- If “E12:No Speaker” appears on the GUI display after the Wiring check, all 9 speakers and 2 subwoofers are not connected. If you did connect all of the speakers and subwoofers, first check the physical connections, then press ENTER, and then Up (RETRY) to retry the Wiring check.

Confirming the results

You can confirm the results of each analysis.

If you set Setup Type to Auto.

The results are displayed after all items have been analysed.



- Press ∇ and select Setup to set the measured values.
- Press Δ and select Retry to retry the auto setup procedure.
- Press \triangleright and select Detail to view information about measurement results and error or warning messages. For more details about error and warning messages, see “Troubleshooting for the auto setup procedure” on page 35.
- Press \triangleleft and select Exit to cancel the auto setup procedure.

If you set Setup Type to Step.

The results are displayed individually after each analysis.



- Press ∇ and select Next to start measurement of the next menu item.
- Press Δ and select Retry to retry the auto setup procedure.
- Press \triangleright and select Detail to view information about measurement results and error or warning messages. For more details about error and warning messages, see “Troubleshooting for the auto setup procedure” on page 35.
- Press \triangleleft and select Exit to cancel the auto setup procedure.

After all menu items have been measured, “Measurement Over” appears on the screen and the results for each item are displayed.

- Press ∇ and select Setup to set the measured values.
- Press Δ and select Retry to retry the auto setup procedure.
- Press \triangleright and select Detail to view information about measurement results and error or warning messages. For more details about error and warning messages, see “Troubleshooting for the auto setup procedure” on page 35.
- Press \triangleleft and select Exit to cancel the auto setup procedure.



If you want to make more detailed settings, change the system parameters using the Manual Setup menu. If you want to return to the Auto Setup settings after making settings in the Manual Setup menu, navigate to the Information screen in the Auto Setup menu, press Δ/∇ repeatedly to select the parameter you want to adjust, then press ENTER.

Notes

- If you change speakers, speaker positions, or the layout of your listening environment, perform auto setup again to re-calibrate your system.
- In the Distance results, the distance displayed may be longer than the actual distance depending on the characteristics of your subwoofer. This may also be the case when using an external amplifier.
- In the Equalizing results, different values may be set for the same band to provide finer adjustments.

■ Troubleshooting for the auto setup procedure

Before auto setup

Error message	Cause	Remedy
Connect MIC!	Optimizer microphone is not connected.	<ul style="list-style-type: none"> Connect the supplied optimizer microphone to the OPTIMIZER MIC jack on the front panel.
Unplug Phones!	Headphones are connected.	<ul style="list-style-type: none"> Unplug the headphones.
No Setup Menu!	No setup menu items have been selected.	<ul style="list-style-type: none"> Select at least one setup menu item.
Memory Guard!	This setting is protected.	<ul style="list-style-type: none"> Remove the protection setting for auto setup (see page 78).

During auto setup

Press </> to display detailed information for individual errors. Select Retry to try the auto setup procedure again.

Error message	Cause	Remedy
E01:No Front SP	Front L/R channel signal(s) is (are) not detected.	<ul style="list-style-type: none"> Select the front speakers with SPEAKERS A or B. Check the front L/R speaker connections.
E02:No Surr. SP	A surround channel signal is not detected.	<ul style="list-style-type: none"> Check the surround speaker connections.
E03:No Pres. SP	A presence channel signal is not detected.	<ul style="list-style-type: none"> Check the presence speaker connections.
E04:SBR ->SBL	Only the surround back right channel signal is detected.	<ul style="list-style-type: none"> Connect the surround back speaker to the LEFT SURROUND BACK SPEAKERS terminal if you only have one surround back speaker.
E05:Noisy	Background noise is too loud.	<ul style="list-style-type: none"> Try auto setup in a quiet environment. Turn off noisy electric equipment like air conditioners, or move it away from this unit.
E06:Check Surr.	Surround back speaker(s) is (are) connected, though surround L/R speakers are not.	<ul style="list-style-type: none"> Connect surround speakers when using (a) surround back speaker(s).
E07:No MIC	The optimizer microphone was unplugged during the auto setup procedure.	<ul style="list-style-type: none"> Connect the supplied optimizer microphone to the OPTIMIZER MIC jack on the front panel.
E08:No Signal	The optimizer microphone does not detect test tones.	<ul style="list-style-type: none"> Check the microphone setting. Check the speaker connections and placement.
E09:User Cancel	The auto setup procedure was cancelled because a setting that affects auto setup was changed during the procedure.	<ul style="list-style-type: none"> Perform the auto setup procedure again.
E10:Internal Err	No DSP response.	<ul style="list-style-type: none"> Restart this unit, then try the auto setup procedure again.
E11:Complex Err	Multiple errors occurred.	<ul style="list-style-type: none"> Check the speaker connections and placement.
E12:No Speaker	All 9 speakers and 2 subwoofers are not connected.	<ul style="list-style-type: none"> Check the speaker connections and placement.

After auto setup

The following warning messages are displayed after analysis is complete to inform you of possible problems. We recommend that you check the contents of each message, then select Retry to try the auto setup procedure again.

Warning message	Cause	Remedy
W1:Out of Phase	Speaker polarity is incorrect. This message may appear depending on the speakers even when they are connected correctly.	<ul style="list-style-type: none"> • Check the speaker connections.
W2:Over24m/80ft	The distance between the speaker and the listening position is over 24 m (80 ft).	<ul style="list-style-type: none"> • Bring the speaker closer to the listening position.
W3:Level Error	The difference in volume level between the speakers is excessive. (No level correction is made.)	<ul style="list-style-type: none"> • Readjust the speaker installation. • Check the speaker connections. • Use speakers of similar quality. • Adjust the output volume of the subwoofer.

PLAYBACK

Basic operations

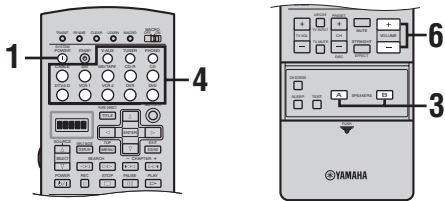
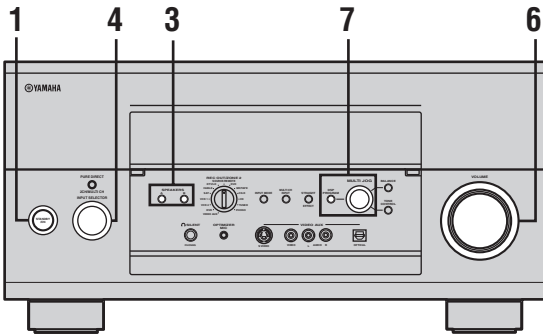

1 Press **STANDBY/ON** (**SYSTEM POWER** on the remote control) to turn on the power.

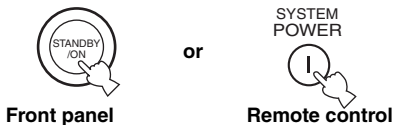

2 Turn on the video monitor connected to this unit.

3 Press **SPEAKERS A** or **B** to select the speakers you want to use.

Each press turns the respective speakers on and off.

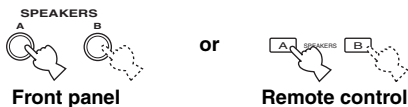

When bi-wiring, select both A and B.

4 Select the input source.

Rotate **INPUT SELECTOR** (or press one of the input selector buttons on the remote control) to select the input you desire.

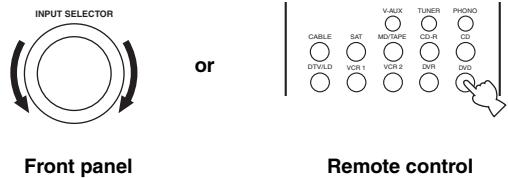

Front panel

Remote control

The current input source name and input mode appear in the front panel display and video monitor for a few seconds.

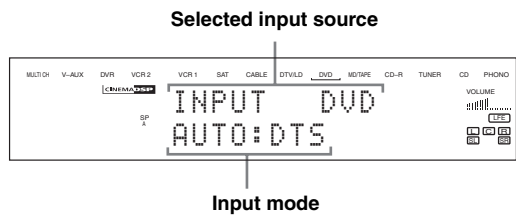

5 Start playback or select a broadcast station on the source component.

Refer to the operating instructions for the component.

6 Adjust the volume to the desired output level.

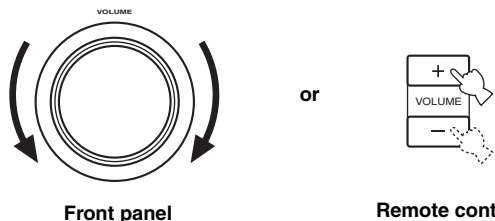

Front panel

Remote control

7 Select a sound field program if desired.

Press DSP PROGRAM then rotate MULTI JOG (or on the remote control, set 10KEY/AMP to AMP, then press one of the sound field program buttons repeatedly) to select a sound field program. (See page 48 for details about sound field programs.)

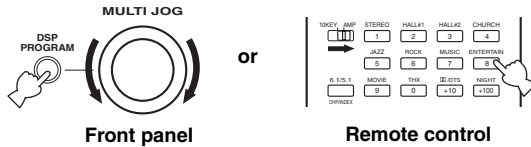

Note

When this unit detects Dolby Digital signals, the following display appears for a few seconds. This shows how the signal level is being corrected to become -27 dB (THX recommendation).

DialNorm* * +4dB

To listen with headphones (SILENT CINEMA)

The SILENT CINEMA mode allows you to enjoy multi-channel music or movie sound, including Dolby Digital and DTS surround, through ordinary headphones. SILENT CINEMA activates automatically whenever you connect headphones to the PHONES jack while listening to CINEMA DSP or HiFi DSP sound field programs. The “SILENT CINEMA” indicator lights up on the front panel display. (If the sound field programs are off, you listen with normal stereo reproduction.)

To adjust the tone

You can adjust the bass/treble balance for the front left/right, center and subwoofer channels. Press TONE CONTROL repeatedly on the front panel to select Treble or Bass.

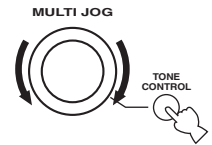

Select Treble, then rotate MULTI JOG to the right or left to increase or decrease the high-frequency response. Select Bass, then rotate MULTI JOG to the right or left to increase or decrease the low-frequency response. To cancel the tone control, press TONE CONTROL repeatedly to select OFF.

Notes

- If you increase or decrease the high-frequency or low-frequency sound to an extreme level, the tonal quality of the surround speakers may not match that of the front left/right and center speakers.
- TONE CONTROL is not effective when:
 - The THX (page 48) or DIRECT STEREO (page 43) program is selected.
 - PURE DIRECT is selected.
- If headphones are connected to this unit, the Tone Control setting adjusts the bass/treble balance of your headphones (page 62).

To mute the sound

Press MUTE on the remote control.

“MUTE” blinks in the front panel display.

To resume the audio output, press MUTE again (or press VOLUME +/-). “MUTE” disappears from the display.



- You can adjust the muting level (see page 64).
- You can also perform this operation using the GUI remote control (see page 29).

■ Selecting MULTI CH INPUT

Press MULTI CH INPUT so that “Input MULTI CH” appears in the front panel display and “MULTI CH ON/OFF” appears on the video monitor.

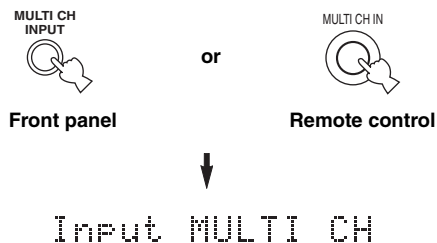

Note

If you want to select another input source with INPUT SELECTOR (or one of the input selector buttons on the remote control) when “Input MULTI CH” is shown on the front panel display or “MULTI CH ON” is shown on the video monitor, press MULTI CH INPUT to turn off this setting.

■ Playing video sources in the background

You can combine a video image from a video source with a sound from an audio source. For example, you can enjoy listening to classical music while having beautiful scenery from the video source on the video monitor.

Use the input selector buttons to select a video source, then select an audio source.

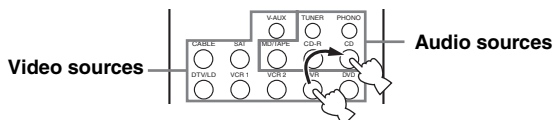

Note

If you want to enjoy audio from the MULTI CH INPUT jacks together with a video source, use the on-screen display menu (see “BGV (Background video)” on page 60).

Selecting sound field programs

■ Front panel operation

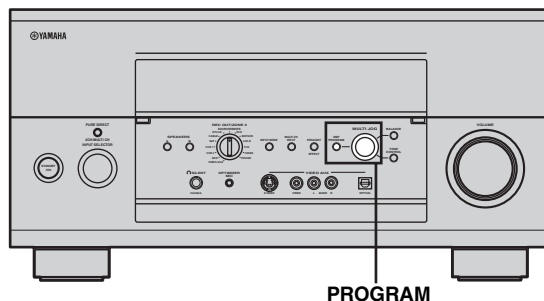

Press DSP PROGRAM, then rotate MULTI JOG to select the desired program.

The name of the selected program appears on the front panel display and on the video monitor.

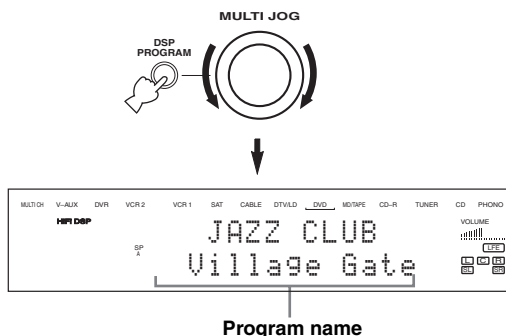

Remote control operation

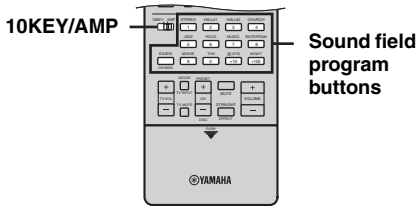

Set 10KEY/AMP to AMP, then press one of the sound field program buttons repeatedly to select the desired program.

The name of the selected program appears on the front panel display and on the video monitor.

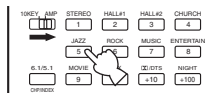

- You can also perform these operations using the GUI remote control (see page 29).
- Choose a sound field program based on your listening preference, and not on the name of the program.

Notes

- When you select an input source, this unit automatically selects the last sound field program used with that source.
- Sound field programs cannot be selected when PURE DIRECT is selected.
- 128 kHz, 176.4 kHz and 192 kHz sampling frequencies are sampled down to half their original sampling frequency before sound field programs are applied.
- DSD signals are converted to PCM (88.2 kHz) before sound field programs are applied.

Enjoying multi-channel software

If you connected a surround back speaker, use this feature to enjoy 6.1/7.1-channel playback for multi-channel sources using the Dolby Pro Logic IIx, Dolby Digital Surround EX or DTS ES decoders.

Press EX/ES on the remote control to switch between 5.1- and 6.1/7.1- channel playback.



To select a decoder, press < / > repeatedly when PLLx Movie (etc.) is displayed.

AUTO

When a signal (flag) that can be recognized by the unit is input, the unit selects the optimum decoder for playing back the signal in 6.1/7.1 channels.

If the unit cannot recognize the flag or no flag is present in the input signal, it cannot automatically be played in 6.1/7.1 channels.

Decoders (select with < / >)

You can select from the following modes depending on the format of the software you are playing.

PLLx Movie

For playing back Dolby Digital, DTS or analog multi-channel signals in 7.1 channels using the Pro Logic IIx movie decoder.

PLLx Music

For playing back Dolby Digital, DTS or analog multi-channel signals in 6.1/7.1 channels using the Pro Logic IIx music decoder.

EX/ES

For playing back Dolby Digital or analog multi-channel signals in 6.1/7.1 channels using the Dolby Digital Surround EX decoder.

DTS signals are played back in 6.1/7.1 channels using the DTS ES decoder.

EX

For playing back Dolby Digital or DTS signals in 6.1/7.1 channels using the Dolby Digital Surround EX decoder.

OFF

Decoders are not used to create 6.1/7.1 channels.



When Surround Back is set to "Large x1" or "Small x1" (see page 68), the surround back channel is output from the left SURROUND BACK speaker terminals.

Notes

- 6.1/7.1-channel playback is not possible even if EX/ES is pressed in the following cases:
 - When Surround or Surround Back is set to “None” (see page 68).
 - When the source being played does not contain surround L/R channel signals.
 - When a Dolby Digital KARAOKE source is being played.
 - When “2ch Stereo”, “9ch Stereo” or “Direct” is selected.
- When this unit’s power is turned off, the mode is reset to Auto.
- When the DTS ES discrete decoder is applied to DTS 96/24 signals, you cannot use the DTS 96/24 decoding feature.
- The Pro Logic IIx decoder is not available when Surround Back in the Basic menu is set to “None” (see page 68).
- “PLIIx Movie” cannot be selected when Surround Back in the Basic menu is set to “Large x1” or “Small x1” (see page 68).
- For 6.1/7.1-channel playback of multi-channel signals input through MULTI CH INPUT, select MULTI CH in the Input Select menu, then set Input Channels to 5.1ch (6.1/7.1-channel processing using the PLIIx decoder) or 7.1ch (plays back external 7.1-channel signals as they are).

■ Enjoying 2-channel software

Signals input from 2-channel sources can also be played back on multiple channels using the Dolby Pro Logic, Dolby Pro Logic II, Dolby Pro Logic IIx, or DTS Neo:6 decoders.

Press /DTS on the remote control to switch between Surround Standard or Surround Enhanced decoding modes.

You can select the decoder used for each decoding mode with the Decode Type parameter in the Stereo/Surround menu (page 107).

**For playback using Surround Standard**

You can use the Decode Type parameter to select from the following decoders.

- Pro Logic
- Pro Logic II Movie
- Pro Logic II Music
- Pro Logic II Game
- Neo:6 Cinema
- Neo:6 Music
- Pro Logic IIx Movie
- Pro Logic IIx Music
- Pro Logic IIx Game

For playback using Surround Enhanced

You can use the Decode Type parameter to select from the following decoders.

- Pro Logic
- Pro Logic II
- Neo:6
- Pro Logic IIx

Note

The Pro Logic IIx decoder is not available when Surround Back in the Basic menu is set to “None” (see page 68).

■ Listening at night

This mode reproduces dialog clearly while reducing the volume of loud sound effects for easier listening at low volumes or at night.

Press **NIGHT** on the remote control.

The NIGHT indicator in the front panel display lights up.

Press NIGHT again to cancel. The NIGHT indicator goes off.



- You can use the night listening mode with any sound field program except Direct Stereo (even though the NIGHT indicator lights up during Direct Stereo mode).
- Night listening mode may vary in effectiveness depending on the input source and surround sound settings you use.

■ Virtual CINEMA DSP

Virtual CINEMA DSP allows you to enjoy the CINEMA DSP programs without surround speakers. It creates virtual speakers to reproduce the natural sound field. If you do not connect surround speakers, Virtual CINEMA DSP activates automatically whenever you select a CINEMA DSP sound field program.

Note

When headphones are connected, Virtual CINEMA DSP will not activate, even when Surround is set to “None” (see page 68).

■ Listening to unprocessed sound

Press STRAIGHT/EFFECT to select STRAIGHT. 2-channel stereo sources are output from the front left and right speakers only. Multi-channel sources are decoded straight into the appropriate channels without any additional effect processing.

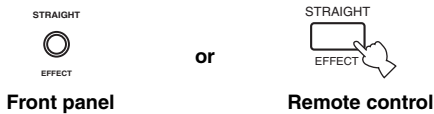

Press STRAIGHT/EFFECT again so that “STRAIGHT” disappears from the display when you want to turn the sound effect back on.



You can also perform this operation using the GUI remote control (see page 29).

■ Downmixing to 2 channels

You can enjoy 2-channel stereo playback even from multi-channel sources.

Press **DSP PROGRAM**, then rotate **MULTI JOG** (or set **10KEY/AMP** to **AMP** then press **STEREO** repeatedly on the remote control) to select “STEREO 2ch Stereo”.

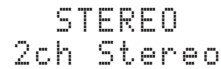
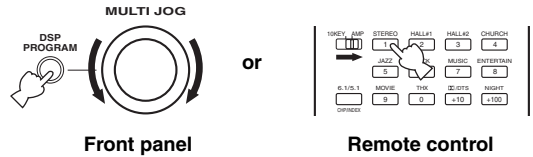

- You can also perform this operation using the GUI remote control (see page 29).
- You can use a subwoofer with this program when SWFR or Both is selected in Bass Out (see page 67).

Listening to uncompromising pure audio

PURE DIRECT allows you to enjoy the highest possible fidelity from audio sources connected to the 2CH IN PURE DIRECT or MULTI CH IN jacks. This function bypasses all of this unit's decoders and digital circuitry to provide uncompromised audio fidelity. It also turns off the front panel display and the power to this unit's video circuitry to eliminate noise.



INPUT SELECTOR cannot be used to select other sources when PURE DIRECT is selected.

Press PURE DIRECT, to activate pure direct mode.

PURE DIRECT



Front panel

or

PURE DIRECT



Remote control

- PURE DIRECT lights green when the MULTI CH IN jacks are selected.
- PURE DIRECT lights blue when the 2CH IN PURE DIRECT jacks are selected.
- To switch between the multi-channel and 2-channel inputs, press MULTI CH IN.

Press PURE DIRECT again to cancel.

Notes

- TONE CONTROL (page 38) and system option settings (page 55) are not effective.
- The front panel display automatically dims when the PURE DIRECT mode is activated.

Listening to high fidelity sources (Analog/DSD/PCM)

To enjoy high quality sound, select the STEREO Direct --- sound field program. The program works with analog, PCM and DSD sources.

Press DSP PROGRAM, then rotate MULTI JOG (or set 10KEY/AMP to AMP and press STEREO repeatedly on the remote control) to select "STEREO Direct ---".



- "STEREO Direct Analog" appears for 2-channel analog sources.
- "STEREO Direct PCM" appears for PCM digital audio sources.
- "STEREO Direct DSD" appears for Super Audio CD sources.



You can also perform this operation using the GUI remote control (see page 29).

Notes

- To avoid unexpected noise, do not play DTS-encoded CDs in this mode.
- No sound is played back when the input mode is set to DTS or D.D.RF.
- When multi-channel signals (Dolby Digital and DTS) are input, this unit automatically selects an analog signal input.
- TONE CONTROL (page 38) and system option settings (page 55) are not effective.
- The front panel display automatically dims when this sound field program is selected.

Selecting input modes

This unit comes with a variety of input jacks. Do the following to select the type of input signals you want to use.

1 Select the input source.

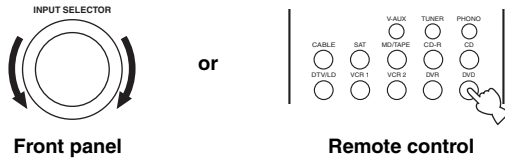

2 Press INPUT MODE (or INPUT MODE when 10KEY/AMP is set to AMP) to select an input mode.

In most cases, use Auto.

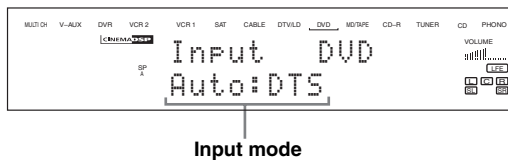
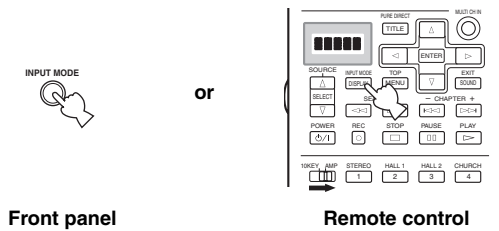

Auto Automatically selects input signals in the following order:

- 1) i.LINK
- 2) Dolby Digital RF
- 3) Digital signals*
- 4) Analog signals

i.LINK Selects only i.LINK signals. If no i.LINK signals are input, no sound is output.

D.D. RF Selects only Dolby Digital RF signals. If no Dolby Digital RF signals are input, no sound is output.

DTS Selects only digital signals encoded in DTS. If no DTS signals are input, no sound is output.

Digital Selects digital signals input from the OPTICAL or COAXIAL jacks. Use if i.LINK or Dolby Digital RF signals are also being input.

Analog Selects only analog signals. If no analog signals are input, no sound is output.

* If this unit detects a Dolby Digital or DTS signal, the decoder automatically switches to the appropriate sound field program.



- You can adjust the default input mode this unit selects when the power is turned on (see page 76).
- If MULTI CH IN is selected, you cannot change the input source using INPUT SELECTOR. Press MULTI CH IN on the remote control or MULTI CH INPUT on the front panel to remove the selection.
- You can also perform this operation using the GUI remote control (see page 29).

Notes

- When playing back CD or LD sources encoded in DTS, set the input mode to DTS.
- If the digital output data of the player has been processed in any way, you may not be able to perform DTS decoding even if you make a digital connection between this unit and the player.
- When "STEREO Direct ---" is selected, playback is not possible in the following cases:
 - For Dolby Digital playback in DDRF mode
 - For DTS playback in DTS mode
 - For all other compressed signal streams

■ Displaying information about the input source

You can display signal information for the audio or video signal currently being input.

Remote control operation

1 Press **TOP** on the GUI remote control.

2 Press **▽** repeatedly to select **Signal Info.**

The signal information appears on the GUI display.



Press **▷** to switch between the Audio Info and Video Info screens.

Audio signal information

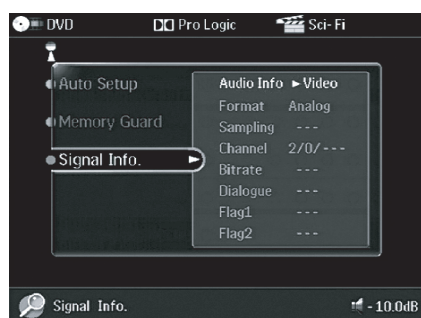

Format

Signal format display. When the unit cannot detect a digital signal, it automatically switches to analog input.

Sampling

Sampling frequency. When the unit is unable to detect the sampling frequency, “Unknown” appears.

Channel

Number of source channels in the input signal. For example, a multi-channel sound track with 3 front channels, 2 surround channels and LFE, is displayed as “3/2/0.1”.

Bitrate

Bit rate. When the unit is unable to detect the bit rate, “Unknown” appears.

Dialogue

Dialog normalization information for Dolby Digital signals.

Flag 1/Flag 2

A signal format capable of identifying special operation commands contained in audio input signals.

Video signal information



Resolution

Resolution for video input/output signals. When the unit is unable to detect the resolution, “--” appears.

- Both the input and output resolution are displayed simultaneously.

Aspect

Aspect ratio for video input/output signals. When the unit is unable to detect the aspect ratio, “--” appears.

- Both the input and output aspect ratios are displayed simultaneously.

Copy Protect

Presence of copyright-protected video input signals. When the unit is unable to determine whether any copyright-protected signals are present, “--” appears.



You can also perform this operation using the GUI remote control (see page 29).

RECORDING

You can use the REC OUT/ZONE 2 control to record one source while watching and/or listening to another source.

Recording adjustments and other operations are performed from the recording components. Refer to the operating instructions for these components.

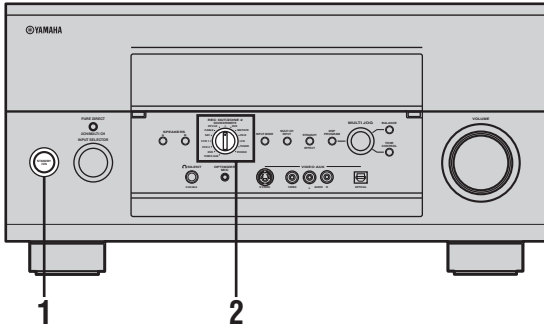

1 Turn on this unit's power and all connected components.

2 Select the source component you want to record from by using REC OUT/ZONE 2.

- To record the current input source you are watching or listening to, set REC OUT/ZONE 2 to SOURCE/REMOTE.

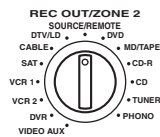

- To record a source other than the one you are watching or listening to, set REC OUT/ZONE 2 to the source you want to record.

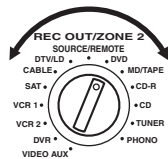

After making this setting, you can change the source you are listening to and/or watching without affecting the recording by rotating INPUT (or pressing one of the input selector buttons on the remote control).

Note

The source you record and the source in Zone 2 are always identical.

3 Start playback (or select a broadcast station) on the source component.

4 Start recording on the recording component.



To record audio and video from different sources, set REC OUT/ZONE 2 to SOURCE/REMOTE, select a video source first, then select an audio source (see page 39).

Notes

- Do a test recording before you start an actual recording.
- When this unit is set in the standby mode, you cannot record between other components connected to this unit.
- The setting of TONE CONTROL, VOLUME, "Speaker Level" (page 69) and programs does not affect the recorded material.
- A source connected to this unit's MULTI CH INPUT jacks cannot be recorded.
- S video and composite video signals pass independently through this unit's video circuits. Therefore, when recording or dubbing video signals, if your video source component is connected to provide only an S video (or composite video) signal, you can record only an S video (or composite video) signal to your VCR.
- A given input source is not output on the same REC OUT channel. (For example, the signal input from VCR 1 IN is not output on VCR 1 OUT.)
- Check the copyright laws in your country to record from records, CDs, radio, etc. Recording of copyrighted material may infringe copyright laws.
- Dolby Digital RF signals are not output from the DIGITAL OUTPUT jacks.
- Signals input through an i.LINK connection are only output to the DIGITAL OUTPUT jacks when REC OUT/ZONE 2 is set to SOURCE/REMOTE (priority is given to input signals from the OPTICAL and COAXIAL jacks).
- Audio signals from CD or DVD video discs input through an i.LINK connection are only output if they come un-encrypted from the playback device. In other words, copy-protected signals input through an i.LINK connection will not be output to the REC OUT jacks.

If you play back a video source that uses scrambled or encoded signals to prevent it from being dubbed, the picture itself may be disturbed due to those signals.

■ Special considerations when recording DTS software

The DTS signal is a digital bitstream. Attempting to digitally record the DTS bitstream will result in noise being recorded. Therefore, if you want to use this unit to record sources that have DTS signals recorded on them, the following considerations and adjustments need to be made.

For LDs, DVDs and CDs encoded with DTS, when your player is compatible with the DTS format, follow its operation instructions to make a setting so that the analog signal is output from the player.

SOUND FIELD PROGRAM DESCRIPTIONS

This unit is equipped with a variety of precise digital decoders that allow you to enjoy multi-channel playback from almost any sound source (stereo or multi-channel). This unit is also equipped with a YAMAHA digital sound field processing (DSP) chip containing several sound field programs which you can use to enhance your playback experience. Most of these sound field programs are precise digital recreations of actual acoustic environments found in famous concert halls, music venues, and movie theaters.



The YAMAHA CINEMA DSP modes are compatible with all Dolby Digital, DTS, and Dolby Surround sources. Set the input mode to Auto (see page 44) to enable this unit to automatically switch to the appropriate digital decoder according to the signal being input.

For movie/video sources

You can select from the following sound fields when playing movie or video sources. The sound fields marked “MULTI” can be used with multi-channel sources, like DVD, digital TV, etc. Those marked “2-CH” can be used with 2-channel (stereo) sources like TV programs, video tapes, etc.

Program	Features	Sources
STEREO: 2ch Stereo	Downmixes multi-channel sources to 2 (left and right) channels or plays back 2-channel sources as is.	MULTI 2-CH
MUSIC VIDEO: Pop/Rock	This program produces an enthusiastic atmosphere and lets you feel as if you are at an actual jazz or rock concert.	
MUSIC VIDEO: DJ	The sound field makes the voice of a disc jockey sound clearer.	
MUSIC VIDEO: Classical/Opera	This program provides excellent vocal depth and overall clarity by restraining excessive reverberation. The surround sound field is relatively moderate but it reproduces beautiful sound using data collected from a concert hall.	
MUSIC VIDEO: Pavillion	This program reproduces vocals clearly, letting you feel the spaciousness of a pavilion. Reverberation, which is somewhat delayed, reproduces the live acoustics unique to a pavilion, and helps to make concert scenes more exciting.	
MOVIE THEATER: Spectacle	CINEMA DSP processing. This program creates the extremely wide sound field of a 70-mm movie theater. It precisely reproduces the source sound in detail, making both the video and the sound field incredibly real. This is ideal for any kind of video source encoded with Dolby Surround, Dolby Digital or DTS (especially large-scale movie productions).	
MOVIE THEATER: Sci-Fi	CINEMA DSP processing. This program clearly reproduces dialog and sound effects in the latest sound form for science fiction films, thus creating a broad and expansive cinematic space amid silence. You can enjoy science fiction films in a virtual-space sound field that includes Dolby Surround, Dolby Digital and DTS-encoded software employing the most advanced techniques.	
MOVIE THEATER: Adventure	CINEMA DSP processing. This program is ideal for precisely reproducing the sound design of the newest 70-mm and multichannel soundtrack films. The sound field is made to be similar to that of the newest movie theaters, so the reverberations of the sound field itself are restrained as much as possible.	
MOVIE THEATER: General	CINEMA DSP processing. This program is for reproducing sounds from 70-mm and multichannel soundtrack films, and is characterized by soft and extensive sound field. The presence sound field. The presence sound field is relatively narrow. It spatially spreads all around and toward the screen, restraining the echo effect of conversations without losing clarity.	
THX: Cinema	THX processing for any multi-channel source. 2-channel sources are decoded by the PRO LOGIC, PRO LOGIC II, PRO LOGIC IIx or DTS Neo: 6 decoder before THX processing. You can select the decoder using the sound field parameter described on page 107.	

Program	Features	Sources
THX: Ultra2 Cinema	THX processing for non EX/ES encoded 5.1 channel sources. This program outputs sound from the surround back L/R speakers using ASA (advanced speaker array) processing. This mode is only available when you have set up a 7.1 speaker system (i.e. two surround back speakers), and the input signal has surround left and surround right contents.	MULTI
THX: Surround EX	THX processing for Dolby Digital and Dolby Digital EX sources. This program is available only when surround back L/R speakers are connected to this unit and when the input source contains surround back channel signals.	
THX: DDD+PLIIx Movie	THX and Dolby Pro Logic IIx Movie processing for Dolby Digital sources.	
THX: DTS+PLIIx Movie	THX and Dolby Pro Logic IIx Movie processing for DTS sources.	
THX: MltIn+PLIIxMovie	THX and Dolby Pro Logic IIx Movie processing for signals input through the MULTI CH INPUT jacks.	
ES Matrix 6.1	THX processing for DTS ES sources.	
SUR. STANDARD: Dolby Digital	Standard 5.1 channel processing for Dolby Digital sources. The ENHANCED version of this program provides additional CINEMA DSP processing.	
SUR. STANDARD: Dolby Digital EX	Standard 6.1 channel processing for Dolby Digital EX sources. The ENHANCED version of this program provides additional CINEMA DSP processing.	
SUR. STANDARD: DDD+PLIIx Movie	Standard Dolby Digital and Dolby Pro Logic IIx Movie processing.	
SUR. STANDARD: DDD+PLIIx Music	Standard Dolby Digital and Dolby Pro Logic IIx Music processing.	
SUR. STANDARD: DTS	Standard 5.1 channel processing for DTS and 96-kHz/24-bit DTS sources. The ENHANCED version of this program provides additional CINEMA DSP processing.	
SUR. STANDARD: DTS ES Mtrx 6.1	Standard 6.1 channel processing for DTS Matrix 6.1 sources. The ENHANCED version of this program provides additional CINEMA DSP processing.	
SUR. STANDARD: DTS ES Dscrt 6.1	Standard 6.1 channel processing for DTS Discrete 6.1 sources. The ENHANCED version of this program provides additional CINEMA DSP processing.	
SUR. STANDARD: DTS 96/24	Standard DTS 96/24-bit processing.	
SUR. STANDARD: DTS 96/24 ES	Standard DTS 96/24 ES processing.	
SUR. STANDARD: DTS+Dolby EX	Standard DTS and Dolby Digital EX processing.	
SUR. STANDARD: DTS+PLIIx Movie	Standard DTS and Dolby Pro Logic IIx Movie processing.	
SUR. STANDARD: DTS+PLIIx Music	Standard DTS and Dolby Pro Logic IIx Music processing.	

SOUND FIELD PROGRAM DESCRIPTIONS

Program	Features	Sources
SUR. STANDARD: Multi In	Indicates that signals are being input through the MULTI CH INPUT jacks.	MULTI
SUR. STANDARD: MultiIn+DolbyD	Dolby Digital processing for signals input through the MULTI CH INPUT jacks.	
SUR. STANDARD: MltIn+PLIIXMovie	Dolby Pro Logic IIx Movie processing for signals input through the MULTI CH INPUT jacks.	
SUR. STANDARD: MltIn+PLIIXMusic	Dolby Pro Logic IIx Music processing for signals input through the MULTI CH INPUT jacks.	
SUR. STANDARD: DSD	Indicates that DSD signals are being input via i.LINK.	
SUR. STANDARD: Multi PCM	Indicates that multi-channel PCM signals are being input via i.LINK.	
SUR. STANDARD: Pro Logic	Standard processing for Dolby Surround sources. The ENHANCED version of this program provides additional CINEMA DSP processing.	2-CH
SUR. STANDARD: PLII Movie	Standard Dolby Pro Logic II processing for movie software.	
SUR. STANDARD: PLII Game	Standard Dolby Pro Logic II processing for game software.	
SUR. ENHANCED: Pro Logic II	CINEMA DSP Enhanced processing for sources decoded by the PRO LOGIC II decoder.	
SUR. STANDARD: PLIIX Movie	Standard Dolby Pro Logic IIx processing for movie software.	
SUR. STANDARD: PLIIX Game	Standard Dolby Pro Logic IIx processing for game software.	
SUR. ENHANCED: Pro Logic IIx	CINEMA DSP Enhanced processing for sources decoded by the PRO LOGIC IIx decoder.	
SUR. STANDARD: Neo:6 Cinema	Standard DTS processing for movie software.	
SUR. ENHANCED: Neo:6	CINEMA DSP Enhanced processing for sources decoded by the DTS Neo:6 decoder.	

For music sources

You can select from the following sound fields when playing music sources.

Program	Features	Sources
SUR. STANDARD: PLII Music	Dolby Pro Logic II processing for music software.	2-CH
SUR. STANDARD: PLIIX Music	Dolby Pro Logic IIX processing for music software.	
SUR. STANDARD: Neo:6 Music	DTS processing for music software.	
STEREO: Direct	Use to output sources without any processing.	MULTI 2-CH
STEREO: 9ch Stereo	Use to output sources from all speakers. This provides a larger sound field and is ideal for background music at parties, etc.	
CONCERT HALL1: Munich A	HiFi DSP processing. This is a large fan-shaped concert hall in Munich which has approximately 2500 seats. Almost the whole interior is made of wood. There is relatively little reflection from the walls, and sound spreads finely and beautifully.	
CONCERT HALL1: Munich B	HiFi DSP processing. This hall is frequently used for recording orchestral music, and is a shoe-box type concert hall with around 1300 seats. The hall is constructed from marble, resulting in relatively flat resonance. Further, the high ceiling causes sound to reverberate for longer than usual.	
CONCERT HALL1: Frankfurt	HiFi DSP processing. This is a large shoe-box type concert hall with around 2400 seats located in Frankfurt. This hall has a very solid, powerful sound. The listener's virtual seat is in the center-right section on the first floor.	
CONCERT HALL1: Stuttgart	HiFi DSP processing. This is a large asymmetrical concert hall with around 2000 seats located in downtown Stuttgart. Sound reflected off the concrete wall located to the left of listeners has a powerful presence.	
CONCERT HALL1: Vienna	HiFi DSP processing. A classic shoe-box type concert hall with approximately 1700 seats. Pillars and ornate carvings create extremely complex reflections which produce a very full, rich sound.	
CONCERT HALL1: Amsterdam	HiFi DSP processing. This is a large 2200 seat shoe-box type concert hall in Amsterdam. It has a circular stage with seats located behind the stage.	
CONCERT HALL2: U.S.A Hall A	HiFi DSP processing. This is a large 2600 seat concert hall in the United States which features a fairly traditional European design. The interior is relatively simple, in the American style. The middle and high frequencies are richly and beautifully reinforced.	
CONCERT HALL2: U.S.A Hall B	HiFi DSP processing. This spacious arch-shaped hall has a dome ceiling and can seat 2600. The ample resonance apparent in the sound is a feature brought about by longer than average period of reverberation. In addition to this, the reflector suspended above the stage allows listeners to experience rich sound from the direction of the stage.	
CONCERT HALL2: LIVE CONCERT	HiFi DSP processing. A large round concert hall with a rich surround effect. Pronounced reflections from all directions emphasize the extension of sounds. The sound field has a great deal of presence, and your virtual seat is near the center, close to the stage.	

SOUND FIELD PROGRAM DESCRIPTIONS

Program	Features	Sources
CHURCH: Tokyo	HiFi DSP processing. The acoustic environment of an ordinary church with moderate reverberations. The reverberation lasts 2.5 seconds. This is ideal for reproducing church organ and choral music.	MULTI 2-CH
CHURCH: Freiburg	HiFi DSP processing. This program recreates the acoustic environment of a big church located in south Germany. The reverberation delay is very long while the early reflections are smaller than with other sound field programs.	
CHURCH: Royaumont	HiFi DSP processing. This program features the sound field created by the refectory (dining hall) of a beautiful medieval Gothic monastery located in Royaumont on the outskirts of Paris.	
JAZZ CLUB: Village Gate	HiFi DSP processing. This is the sound field at a jazz club in New York. It is in a basement and has a relatively spacious floor area. The listener's virtual seat is at the center left of the hall.	
JAZZ CLUB: Village Vanguard	HiFi DSP processing. A traditional jazz club in New York, located on 7th Avenue. This room has a low ceiling, and the "stage" is located in a corner. This program creates an intimate "close-to-the music" feel.	
JAZZ CLUB: The Bottom Line	HiFi DSP processing. This is the sound field at stage front in "The Bottom Line", a famous New York jazz club. The floor can seat 300 people to the left and right in a sound field offering a real and vibrant sound.	
ROCK CONCERT: The Roxy Theatre	HiFi DSP processing. The ideal program for lively, dynamic rock music. The data for this program was recorded at LA's "hottest" rock club. The listener's virtual seat is at the center-left of the hall.	
ROCK CONCERT: Warehouse Loft	HiFi DSP processing. This program simulates a space enclosed by concrete. An energetic sound field is created with relatively clear reflections from the walls.	
ROCK CONCERT: Arena	HiFi DSP processing. This program gives you long delays between direct sounds and effect sounds, with the extraordinarily spacious feel of a large arena.	
ENTERTAINMENT: Disco	HiFi DSP processing. This program recreates the acoustic environment of a lively disco in the heart of a big city. The sound is dense and highly concentrated. It is also characterized by high-energy, "immediate" sound.	
ENTERTAINMENT: Party	HiFi DSP processing. This is a sound field suitable for back-ground music at parties where you can hear the sound directly from the rear as well, thus realizing music enjoyment over a wide area.	
THX: Music	THX processing for all 5.1 encoded music sources. This program outputs sound from the surround back L/R speakers using ASA (advanced speaker array) processing. This mode is only available when you have set up a 7.1 speaker system (i.e. two surround back speakers), and the input signal has surround left and surround right contents.	MULTI

ADVANCED OPERATIONS

Selecting the OSD mode

You can also display simple text information about this unit's operation status on your video monitor.

1 Turn on the video monitor connected to this unit.

2 Press ON SCREEN repeatedly to turn the OSD mode on or off.

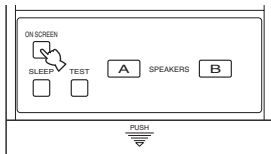

ON

Briefly shows the contents of the front panel display at the bottom of the screen each time you operate this unit.

OFF

The contents of the front panel display are not shown.

Notes

- When 16:9 Zoom is selected for Aspect, the OSD is not displayed even if it is set to ON.
- The OSD signal is not output to the REC OUT jack, and will not be recorded.

Using the sleep timer

Use this feature to automatically set this unit in the standby mode after a certain amount of time. The sleep timer is useful when you are going to sleep while this unit is playing or recording a source. The sleep timer also automatically turns off any external components connected to the AC OUTLET(S).

Setting the sleep timer

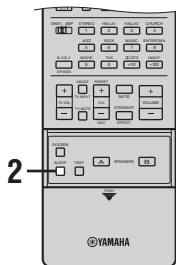

1 Select a source and start playback on the source component.

2 Press SLEEP repeatedly to set the amount of time.

Each time you press SLEEP, the front panel display changes as shown below. The SLEEP indicator flashes while switching the amount of time for the sleep timer.

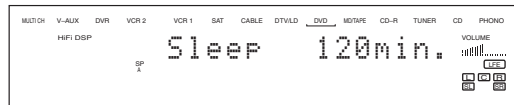
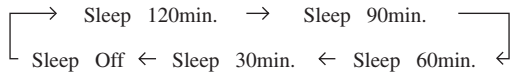

The "SLEEP" indicator lights up on the front panel display after the sleep timer has been set.

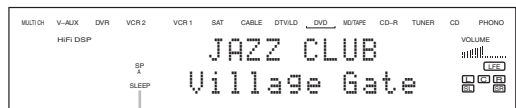

Lights up

Canceling the sleep timer

Press SLEEP repeatedly until "Sleep Off" appears on the front panel display.

After a few seconds, "Sleep Off" disappears, and the "Sleep" indicator goes off.



The sleep timer setting can also be canceled by pressing STANDBY on the remote controls (or STANDBY/ON on the front panel) to set this unit in the standby mode.

Using the test tone

You can use the test tone feature to manually balance your speaker levels. Please note that this operation will override the level adjustments made in the auto setup procedure (page 31) and "Speaker Level" (page 69). Use the test tone to set speaker levels so that the volume from each speaker is identical when heard from your listening position.

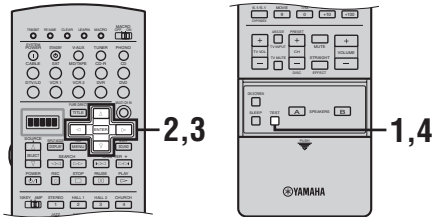

1 Press TEST.

The unit outputs a test tone.

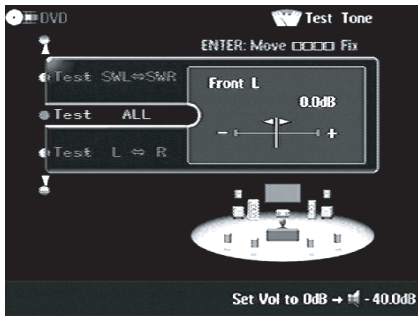

2 Press Δ/∇ repeatedly to select the speaker you want to adjust.

TEST L->R	Front left and right speakers
TEST L->C	Center speaker
TEST L->SL	Surround left speaker
TEST SL->SR	Surround right speaker
TEST SL->SB	Surround back speaker*
TEST SL->SBL	Surround back left speaker
TEST SBL->SBR	Surround back right speaker
TEST L->PL	Presence left speaker
TEST PL->PR	Presence right speaker
TEST L->SWL	Left subwoofer
TEST SWL->SWR	Right subwoofer
TEST ALL	All speakers

* Select if you are using only one surround back speaker.

Notes

- If a speaker is not connected, the corresponding adjustment(s) will not be displayed.
- If you are using only one surround back speaker, balance its level against that of the surround left speaker.
- When the Subwoofer Set "Config." parameter is set to Monaural (see page 66), balance the levels of both SWL and SWR speakers against that of the front left speaker.

3 Press $\triangleleft/\triangleright$ to adjust the speaker volumes.

4 Press TEST once more when you have completed your adjustment.

The test tone stops.



- Use a handheld SPL meter, hold at arms length and point upwards so that the meter is in the listening position. With the meter set to the 70 dB scale and to C SLOW, calibrate each speaker to 75 dB.
- Before outputting the test tone, we recommend that you set the output volume to 0 dB.
- Press ENTER while outputting the test tone to switch the test tone to the currently selected set of speakers. Hold down ENTER for 2 seconds or more to fix the test tone to output only from the current speaker. The upper right area of the screen changes as follows:

ENTER: Move 0000 Fix



If you press ENTER for 2 seconds or more...

ENTER: Move ■■■■ Fix

...the output speaker is fixed.

Note

You cannot enter the test mode if headphones are connected to the PHONES jack. Remove the headphones from the PHONES jack.

SYSTEM OPTIONS

You can use the following parameters to adjust a variety of system settings and customize the way this unit operates. Change the initial settings (indicated in bold under each parameter) to reflect the needs of your listening environment.

■ Stereo/Surround (Stereo/Surround)

Use to manually adjust the sound of your speakers.

■ Input Select (Input select)

Use to reassign digital input/outputs, select the input signal, rename the inputs, or adjust the output volume of each jack.

Item	Features	Page
Mode	Selects the input signal.	58
Volume Trim	Adjusts the output volume of each jack.	59
Assign	Assigns jacks according to the component to be used.	59
Rename	Changes the name of the input.	59
Analog Level	Selects the analog input level.	60
BGV	Selects the video source to be output when MULTI CH is selected.	60
Input Channels	Selects the number of audio channels input through the MULTI CH INPUT jacks.	60

■ Manual Setup (Manual setup)

Use to manually adjust speaker and system settings.

Sound (Sound)

Use to manually adjust the sound parameters.

Item	Features	Page
Cinema EQ	Adjusts the source sound to your liking.	61
Graphic EQ	Adjusts the tonal quality of each speaker.	61
Tone Control	Adjusts the tonal balance of the speakers and headphones.	62
LFE Level	Adjusts the output level of the LFE channel for Dolby Digital or DTS signals.	63
Dynamic Range	Adjusts the dynamic range for Dolby Digital or DTS signals.	63
Audio Option	Customizes overall audio settings for this unit.	63

Basic (Basic)

Use to quickly setup basic system parameters.

Item	Features	Page
THX Set	Selects the subwoofer and surround back speaker settings suitable for THX.	65
Subwoofer Set	Selects settings for your subwoofer(s).	66
Speaker Set	Selects the output mode suitable for each speaker, the speakers for low-frequency signal output, and the cross over frequency.	67
Speaker Level	Adjusts the output level of each speaker.	69
Speaker Distance	Adjusts the delay time of each speaker.	70

Video (Video)

Use to manually adjust the video parameters.

Item	Features	Page
Processor	Turns on/off the digital video processor.	71
Picture Mode	Selects and adjusts the video picture mode suitable for the video picture.	72
Resolution	Selects the video resolution.	72
Aspect	Selects the aspect ratio.	73
Cross Color	Removes noise from image brightness.	74
TV Format	Selects the video format.	74
S Video	Selects the output of video devices.	75

Option (Option)

Use to adjust the optional system settings.

Item	Features	Page
Surr.Initialize	Initializes the parameters of all or a group of sound field programs.	76
Input Mode	Selects the initial input mode of the source.	76
Display	Adjusts the on-screen and front panel displays.	77
Multi Zone	Customizes the Zone 2 and Zone B settings.	77

■ **Auto Setup (Auto setup)**

Use to specify which speaker parameters auto setup will adjust, and to activate the auto setup procedure (see page 31).

■ **Memory Guard (Memory Guard)**

Use to lock the on-screen display menu parameter settings.

Item	Features	Page
i.LINK Setup	Locks i.LINK Select settings.	78
Surr.Parameter	Locks Stereo/Surround settings.	78
Input Setup	Locks Input Select settings.	78
Manual Setup	Locks Manual Setup settings.	79
Auto Setup	Locks Auto Setup settings.	79

■ **Signal Info. (Signal Info.)**

Use to check audio and video signal information (see pages 45).

■ **i.LINK Select (i.LINK Select)**

Use to customize the i.LINK Select connection or display information (see page 98).

Changing parameter settings

Use the GUI remote control to access and adjust each parameter.

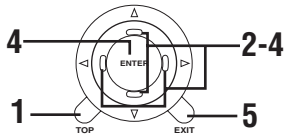

You can also perform this operation using the remote control (see page 29).

1 Press TOP on the GUI remote control.

2 Press Δ/∇ repeatedly to select a menu, then press \triangleright to enter the selected menu.

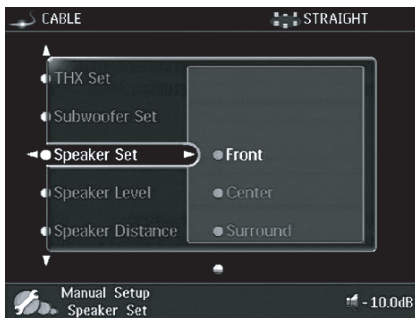

3 Press Δ/∇ repeatedly to select the parameter you want to adjust.



4 Press ENTER or \triangleright , then press Δ/∇ repeatedly to change the setting of the item you want to adjust.



5 Press EXIT.

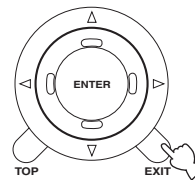

If you want to continue adjusting parameter settings, press ENTER to return to the previously selected menu item.

Notes

- The available parameters may be displayed on more than one page of the on-screen display. To scroll through pages, press Δ/∇ .
- You cannot change parameter values when Memory Guard is set to "Guard". If you want to change the parameter values, set Memory Guard to "Free" (see page 78).

Memory back-up

The memory back-up circuit prevents the stored data from being lost even if this unit is set in the standby mode, the power cord is disconnected from the AC outlet, or the power supply is temporarily cut due to power failure. However, if the power is cut for more than one week, the parameter values will return to the factory settings. If this happens, edit the parameter value again.

Input Select

Use this feature to reassign digital input/outputs, select the input signal, rename the inputs, or adjust the level of the signal input to each jack.

1 Press TOP on the GUI remote control.

2 Select Input Select, then press \triangleright .

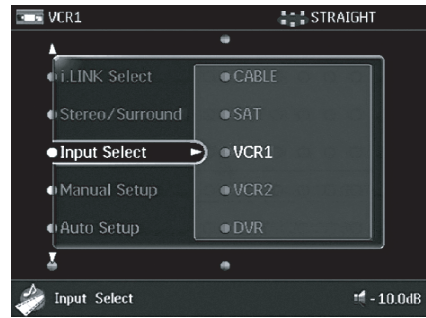

3 Select the desired input (CD, DVD, etc.), then press \triangleright to access and adjust.

Mode (Mode)

Use this feature to select the input signal.

Input Select > input source (DVD, etc.) > Mode

Choices: Auto, D.D.RF, DTS, Digital, i.LINK, Analog



- This menu is only available for input sources that have been assigned digital jacks.
- Before you can select i.LINK, you must first connect this unit to an i.LINK component and assign it to an input.
- Before you can select D.D.RF, you must first select DTV/LD as the input source and then specify ① LD-RF for the Coaxial Input (see page 59).

■ Volume Trim (Volume trim)

Use this feature to adjust the level of the signal input to each jack. This is useful if you want to balance the level of each input source to avoid sudden changes in volume when switching between input sources.

Input Select > input source (DVD, etc.) > Volume Trim
Control range: -6.0 to +6.0

■ Assign (Assign)

You can assign the digital audio input/output and component video jacks to other components if this unit's initial settings do not correspond to your needs. Change the following parameters to reassign the jacks and effectively connect more components.

Once the jacks are reassigned, you can select the corresponding component using INPUT SELECTOR on the front panel or the input selector buttons on the remote control.

Input Select > input source (DVD, etc.) > Assign >

Example 1:

To assign the COAXIAL ① (DTV/LD) jack to the DVD input.

- 1) Select Input Select, then select DVD.
- 2) Select Assign > Coaxial Input, then select ① DTV/LD.

Example 2:

To clear a jack assignment.

- 1) Select Input Select, then select the input source (DVD, etc.).
- 2) Select Assign, then select the jack assignment (Coaxial Input, Optical Input, Optical Output or Component Video).
- 3) Select None, then press ENTER to clear the assignment.



Notes

- You cannot select a specific item more than once for the same type of jack.
- When you connect a component to both the COAXIAL and OPTICAL jacks, priority is given to the input signals from the COAXIAL jack.
- If you want to use the COAXIAL ① (DTV/LD) jack to input Dolby Digital RF signals, assign the DTV/LD input source to the Coaxial Input (① DTV/LD), then press ▷ to select ① LD-RF.

■ Rename (Rename)

Use this feature to change the name of the inputs on the GUI and front panel display. (DVD is used as the source component in the following example.)

Input Select > input source (DVD, etc.) > Rename

- 1 Press an input selector button to select the input you want to change the name of.
- 2 Press ◀/▶ to place the _ (under-bar) under the space or character you want to edit.



- 3 Press ENTER to select a character type (CAPITAL/SMALL/FIGURE/MARK).
- 4 Press ▲/▼ to select the character you want to use and ◀/▶ to move to the next one.
 - You can use up to 8 characters for each input.
 - Press ▼ to change the character in the following order, or press ▲ to go in the reverse order: A to Z, 0 to 9, a to z, #, *, +, etc.
 - Repeat steps 1 to 3 to rename each input.
- 5 Select the OK button and press ENTER when complete.

■ **Analog Level (Analog level)**

Use this feature to select the analog input signal.

Input Select > input source (DVD, etc.) > Analog Level

Choices: STD, HIGH

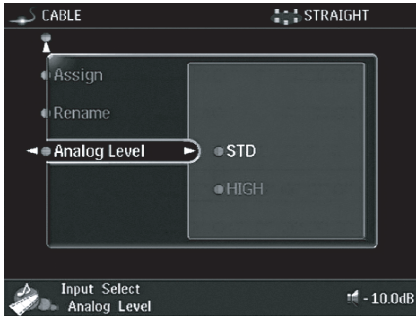

- Normally, select STD.
- Select HIGH if the analog input level is higher than normal or the sound seems distorted.

■ **BGV (Background video)**

Use this feature to select which video signal will be output when MULTI CH is selected.

Input Select > MULTI CH > BGV

Choices: DVD, DTV/LD, CABLE, SAT, VCR1, VCR2, DVR, V-AUX, Last, OFF

- Select Last if you want this unit to use the last video input source that was selected.
- Select OFF if you do not want a video image to be output.

Note

Even when Last is selected, the last video input source selected will not be used after PURE DIRECT is selected or this unit is set to standby mode.

■ **Input Channels (Input channels)**

Use this feature to specify the number of audio channels input through the MULTI CH INPUT jacks.

Input Select > MULTI CH > Input Channels

Choices: 2ch, 5.1ch, 7.1ch



- Select 2ch if you want to input stereo audio signals using only the FRONT L/R jacks.
- Select 5.1ch if you want to input 5.1-channel audio signals through the FRONT L/R, CENTER, SURROUND L/R and SUBWOOFER jacks.
- Select 7.1ch if you want to input 7.1-channel audio signals through all jacks.

Manual setup: Sound

Use this menu to adjust the sound parameters.

1 Press TOP on the GUI remote control.

2 Select Manual Setup, then press \triangleright .



3 Select Sound, then press \triangleright .

4 Select the desired parameters, then press \triangleright to access and adjust.

■ Cinema EQ (Cinema equalizer)

Use this feature to adjust PEQ and high frequency levels for any speaker.

Manual Setup > Sound > Cinema EQ

Choices: Off, On, PEQ*, HIGH*

* When PEQ or HIGH is selected, you can set a frequency between 1.0 and 12.7 kHz and a level between -9 and +3 dB.

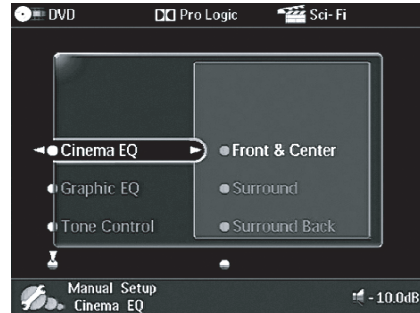

- **Front & Center** adjusts levels for the front left, front right, and center speakers.
- **Surround** adjusts levels for the surround left and surround right speakers.
- **Surround Back** adjusts levels for the surround back left and surround back right speakers.
- **Presence** adjusts levels for the front presence left and right speakers.

■ Graphic EQ (Graphic equalizer)

Use this feature to select the parametric (Auto Setup PEQ) or graphic equalizer (Manual GEQ).

To access these parameters, select:

Manual Setup > Sound > Graphic EQ >

EQ Select (Equalizer select)

Choices: **Auto Setup PEQ**, Manual GEQ, EQ Defeat

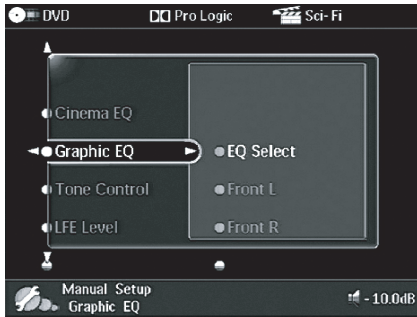

- Select Auto Setup PEQ to use the equalizer adjusted in auto setup.
- Select Manual GEQ to adjust the built-in 9-band graphic equalizer so that the tonal quality of the presence L/R, center, surround L/R and surround back L/R speakers matches that of the front left and right speakers.
- Select EQ Defeat to cancel equalizing.

Choices: -6 to +6 (dB)

You can adjust 9 frequency bands: 63Hz, 125Hz, 250Hz, 500Hz, 1kHz, 2kHz, 4kHz, 8kHz, 16kHz

- **Front L** adjusts the tonal quality of the front left speaker.
- **Front R** adjusts the tonal quality of the front right speaker.
- **Center** adjusts the tonal quality of the center speaker.
- **Surround L** adjusts the tonal quality of the surround left speaker.
- **Surround R** adjusts the tonal quality of the surround right speaker.
- **Surround Back L** adjusts the tonal quality of the surround back left speaker.
- **Surround Back R** adjusts the tonal quality of the surround back right speaker.
- **Presence L** adjusts the tonal quality of the presence left speaker.
- **Presence R** adjusts the tonal quality of the presence right speaker.

Note

Cinema EQ and Graphic EQ adjustments do not affect the output to your headphones.

Tone Control (Tone control)

Use to adjust the amount of bass and treble output to your speakers and headphones.

Manual Setup > Sound > Tone Control >

Control (Tone control)

Choices: Defeat, Speaker, Headphone



- Select Defeat if you do not want to make any adjustments.
- Select Speaker to adjust the bass/treble balance of your speakers.
- Select Headphone to adjust the bass/treble balance of your headphones.

Bass (Bass control)

Use this feature to adjust low-frequencies output to your speakers or headphones.

Choices: -6 to +6 (dB), Initial: 0 dB

You can adjust three frequency bands: 125Hz, 350Hz, 500Hz.



Treble (Treble control)

Use this feature to adjust high-frequencies output to your speakers or headphones.

Choices: -6 to +6 (dB), Initial: 0 dB

You can adjust three frequency bands: 2.5kHz, 3.5kHz, 8.0kHz.



Note

TONE CONTROL is not effective when:

- The THX (page 49) or DIRECT STEREO (page 43) program is selected.
- PURE DIRECT is selected.

LFE Level (Low-frequency effect level)

Use to adjust the output level of the LFE (low-frequency effect) channel according to the capacity of your subwoofer or headphones. The LFE channel carries low-frequency special effects which are only added to certain scenes. This setting is effective only when this unit decodes Dolby Digital or DTS signals.

To access these parameters, select:

Manual Setup > Sound > LFE Level >

Choices: -20 to 0 (dB)



Speaker (Speaker)

Select to adjust the speaker LFE level.

Headphone (Headphone)

Select to adjust the headphone LFE level.

Note

Depending on the settings of LFE Level, some signals may not be output from the SUBWOOFER jack.

Dynamic Range (Dynamic range)

Use to select the amount of dynamic range compression to be applied to your speakers and headphones. This setting is effective only when the unit is decoding Dolby Digital and DTS signals.

To access these parameters, select:

Manual Setup > Sound > Dynamic Range >

Choices: **MAX** (maximum), **STD** (standard), **MIN** (minimum)



Speaker (Speaker)

Select to adjust the speaker compression.

Headphone (Headphone)

Select to adjust the headphone compression.

- Select MAX for feature films.
- Select STD for general use.
- Select MIN for listening to sources at low volume levels.

Audio Option (Audio option)

Use to customize this unit's overall audio settings.

To access these parameters, select:

Manual Setup > Sound > Audio Option >

Audio Delay (Audio delay)

Use to delay the sound output and synchronize it with the video image. This may be necessary when using certain LCD monitors or projectors.

Choices: 0 to 200 (ms)



Muting Type (Muting type)

Use to adjust how much the mute function reduces the output volume.

Choices: Full, -20dB



- Select Full to completely halt all output of sound.
- Select -20dB to reduce the current volume by 20 dB.

Manual setup: Basic

Use this menu to set up basic system parameters.

1 Press TOP on the GUI remote control.

2 Select Manual Setup, then press ▷.



3 Select Basic, then press ▷.

4 Select the desired parameters, then press ▷ to access and adjust.



- Most of the parameters described in the basic menu are set automatically when you run auto setup. You can use the basic menu to make further adjustments, but we recommend running auto setup first.
- You can reset these parameters by performing the auto setup procedure (see page 32).

THX Set (THX settings)

Use to manually adjust the THX settings.

Manual Setup > Basic > THX Set >

THX Ultra2 SWFR (THX Ultra2 subwoofer)

Use this feature to select the THX Ultra2-compatible subwoofer.

Choices: No*, Yes



- Select No if you do not want to use the subwoofer.
- Select Yes if you want to use the subwoofer.
 - * When No is selected, Bndry Gain Comp (boundary gain compensation) is set to Off.

Bndry Gain Comp (Boundary gain compensation)

Use this feature to improve boomy bass when the listening position is close to the rear wall.

Choices: Off, On



- Select Off if you do not want to use the Bndry Gain Comp function.
- Select On to use the Bndry Gain Comp function.

SB Speaker Dist. (Surround back speaker distance)

Use this feature to optimize the surround sound field when you have to place the surround back speakers apart.

Choices:

U.S.A. and Canada models: under 1ft, 1 – 4ft, over 4ft

Other models: under 0.3m, 0.3 – 1.2m, over 1.2m



- Select under 0.3m or under 1ft if the distance between the two surround back speakers is less than 0.3 m (1 foot).
- Select 0.3 – 1.2m or 1 – 4ft if the distance between the two surround back speakers is between 0.3 and 1.2 m (1 and 4 feet).
- Select over 1.2m or over 4ft if the distance between the two surround back speakers is more than 1.2 m (4 feet).

■ Subwoofer Set (Subwoofer set)

Use to manually adjust any setting for your subwoofer.

Manual Setup > Basic > Subwoofer Set >

Config. (Subwoofer configuration)

Use this feature to configure the position of the subwoofers.

Choices: Front & Rear, Stereo, Monaural, None



- Select Front & Rear if your two subwoofers are in the front and rear sound fields.
- Select Stereo if your two subwoofers are in the front right and left sound fields.
- Select Monaural if your subwoofer(s) are in a single sound field.
- Select None if you do not have any subwoofers.

Phase (Phase)

If bass sounds are lacking or unclear, use this feature to adjust the frequency phase characteristics of your subwoofer(s). Try reversing the phase for both the left and right subwoofer speakers together using L&R Reverse, and if the sound is still not satisfactory, try adjusting the phase for these speakers individually.

Choices: Normal, L Reverse, R Reverse, L&R Reverse



- Select Normal if you do not want to reverse the phase for your subwoofer(s).
- Select L Reverse to reverse the phase for the left subwoofer.
- Select R Reverse to reverse the phase for the right subwoofer.
- Select L&R Reverse to reverse the phase for both the left and right subwoofer speakers.

Bass Out (Bass out)

LFE signals carry low-frequency effects when this unit decodes Dolby Digital or DTS signals. These low-frequency signals can be directed to both front left and right speakers, and to the subwoofer (which can be used for both stereo reproduction and sound field programs). Choices: Both, **SWFR**, Front

Note

You may not be able to select certain items depending on your subwoofer configuration (Config.) settings.



- Select Both to direct LFE signals to the subwoofer. Front L/R low-frequency signals are directed to both the subwoofer and front channels, and all other low-frequency signals are directed in accordance with other speaker settings.
- Select SWFR if you connected a subwoofer. The unit directs all LFE and low-frequency signals in accordance with other speaker settings.
- Select Front if you have not connected a subwoofer. The unit directs all low-frequency and LFE signals to the front speakers (even if you have previously set Front to Small in Speaker Set).

Speaker Set (Speaker set)

Use to manually adjust any speaker setting.
Manual Setup > Basic > Speaker Set >

Note

Set any THX speakers to Small.

Front (Front speakers)

Choices: Large, **Small**

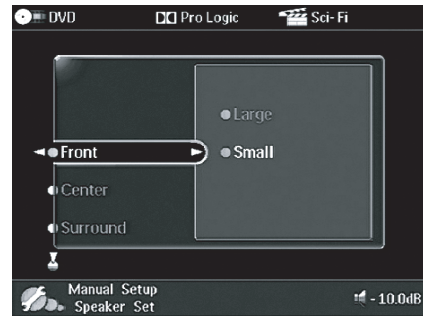

- Select Large if you have large front speakers. The unit directs the entire range of the front left and right channel signals to the front left and right speakers.
- Select Small if you have small front speakers. The unit directs the low-frequency signals of the front channel to the speakers selected with “Bass Out”.

Center (Center speaker)

Choices: Large, **Small**, None



- Select Large if you have a large center speaker. The unit directs the entire range of the center channel signal to the center speaker.
- Select Small if you have a small center speaker. The unit directs the low-frequency signals of the center channel to the speakers selected with “Bass Out”.
- Select None if you do not have a center speaker. The unit directs all of the center channel signal to the front left and right speakers.

Surround (Surround left/right speakers)

Choices: Large, **Small**, None



- Select Large if you have large surround left and right speakers or if a rear subwoofer is connected to the surround speakers. The entire range of the surround channel signal is directed to the surround left and right speakers.
- Select Small if you have small surround left and right speakers. The low-frequency signals of the surround channel are directed to the speakers selected with “Bass Out”.
- Select None if you do not have surround speakers. This sets the unit to the Virtual CINEMA DSP mode (see page 42) and automatically sets the surround back speaker setting (Surround Back) to None.

Surround Back (Surround back left/right speakers)

Choices: Large x1, Small x1, **Small x2**, Large x2, None



- Select Large x1 if you have a large surround back speaker. The unit directs the entire range of the surround back channel signal to the surround back left speaker.
- Select Small x1 if you have a small surround back speaker. The low-frequency signals of the surround back channel are directed to the speakers selected with “Bass Out”, and the rest of the frequency signals are directed to the surround back left speaker.
- Select Small x2 if you have two small surround back speakers. The low-frequency signals of the surround back channels are directed to the speakers selected with “Bass Out”.
- Select Large x2 if you have two large surround back speakers. The unit directs the entire range of the surround back channel signal to the surround back speakers.
- Select None if you do not have a surround back speaker. The unit directs all of the surround back channel signal to the surround left and right speakers.

Note

If you select Large x1 or Small x1, connect a speaker to the SURROUND BACK (SINGLE) speaker terminals.

Presence (Presence speakers)

Choices: None, **Yes**



- Select None if you do not have presence speakers. This unit directs all presence channel signals to the front left and right speakers.
- Select Yes if you have presence speakers.

Note

When Zone2 Amplifier is set to Internal (see page 78), Presence is automatically set to None.

Cross Over (Cross over)

Use this feature to select a cross-over (cut-off) frequency for all low-frequency signals. All frequencies below the selected frequency are sent to the subwoofer.

Choices: 40Hz, 60Hz, **80Hz (THX)**, 90Hz, 100Hz, 110Hz, 120Hz, 160Hz, 200Hz

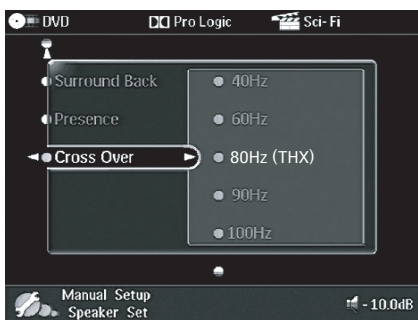

- Select 80Hz (THX) when using a THX system.

Speaker Level (Speaker level)

Use these settings to manually balance the speaker levels between the front left speakers and each speaker selected in Speaker Set (see page 67).

Manual Setup > Basic > Speaker Level



Choices: -10.0 dB to +10.0 dB

- **Front L** adjusts the balance of the front left speaker.
- **Front R** adjusts the balance of the front right speaker.
- **Center** adjusts the balance of the center speaker.
- **Surround L** adjusts the balance of the surround left speaker.
- **Surround R** adjusts the balance of the surround right speaker.
- **Surround Back L** adjusts the balance of the surround back left speaker.
- **Surround Back R** adjusts the balance of the surround back right speaker.
- **Presence L** adjusts the balance of the front left and presence left speakers.
- **Presence R** adjusts the balance of the front left and presence right speakers.
- **Subwoofer L** adjusts the balance of the left subwoofer.
- **Subwoofer R** adjusts the balance of the right subwoofer when two subwoofers are connected.



To calibrate correctly to THX reference levels, use the internal pink noise generator (see page 54).

Notes

- You cannot adjust the level of channels set to None in Speaker Set.
- If you are only using one surround back speaker, connect it to the SURROUND BACK (SINGLE) jack, and adjust the balance in Surround Back L.

Speaker Distance (Speaker distance)

Use this feature to manually input the distance of each speaker and adjust the delay applied to the respective channel. Ideally, each speaker should be the same distance from the main listening position. However, this is not possible in most home situations. Thus, a certain amount of delay must be applied to the sound from each speaker so that all sound will arrive at the listening position at the same time.

To access these parameters, select:
Manual Setup > Basic > Speaker Distance >



Choices: 0.3 to 24.00 m (1 to 80 ft)

Initial setting for all speakers:

U.S.A. and Canada models: 10.0 feet

Other models: 3.0 meters

- **Front L** adjusts the distance of the front left speaker.
- **Front R** adjusts the distance of the front right speaker.
- **Center** adjusts the distance of the center speaker.
- **Surround L** adjusts the distance of the surround left speaker.
- **Surround R** adjusts the distance of the surround right speaker.
- **Surround Back L** adjusts the distance of the surround back left speaker.
- **Surround Back R** adjusts the distance of the surround back right speaker.
- **Presence L** adjusts the distance of the presence left speaker.
- **Presence R** adjusts the distance of the presence right speaker.
- **Subwoofer L** adjusts the distance of the front or left subwoofer.
- **Subwoofer R** adjusts the distance of the rear or right subwoofer when two subwoofers are connected.

Note

If you reset the default setting for Unit, the above values are also reset.

Unit (Unit)

Choices: **meters** (m), feet (ft)

Initial setting:

U.S.A. and Canada models: feet (ft)

Other models: meters (m)

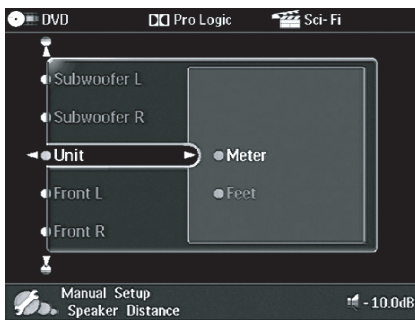

- Select meters to input speaker distances in meters.
- Select feet to input speaker distances in feet.

Manual setup: Video

Use this menu to adjust the video parameters.



If output to the monitor fails while you are performing the parameter setup procedure, the setting of this unit's video parameters could be incompatible with your video monitor. Press and hold down EXIT on the remote control for 5 seconds or longer to initialize the Video parameters.

Initial settings:

- TV format (TV format):
 - U.S.A., Canada, Korea and General models: NTSC
 - Other models: PAL
- Resolution (resolution): 480i/576i
- Only TV Format and S Video are available for progressive or high definition signals (signals with a resolution of 480p/576p or greater).
- Image processing may not be available for non-standard signals such as those output by some game machines.

1 Press TOP on the GUI remote control.

2 Select Manual Setup, then press \triangleright .

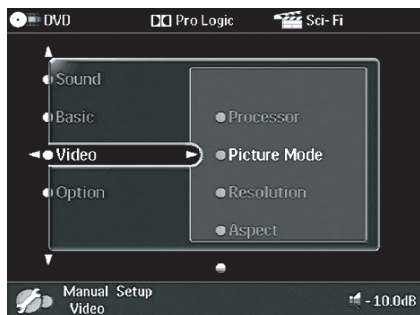

3 Select Video, then press \triangleright .

4 Select the desired parameters, then press \triangleright to access and adjust.

Processor (Processor)

Use this feature to turn on/off the digital video processors.

Manual Setup > Video > Processor

Choices: Off, On

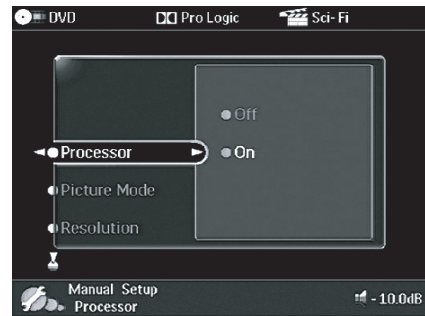

- Select Off to turn off the digital video processors.*
- Select On to turn on the digital video processors.
 - * The signal is output without effect processing. (This setting does not affect the GUI display.)

Notes

- For optimal video performance, THX recommends setting Processor to Off.
- When playing back video that contains teletext or other additional signals, the additional signals may not be played back if you select On. If this happens, select Off.
- When you press TOP on the GUI remote control, the video processing system is enabled and the GUI screen displayed even if Off is selected.

Picture Mode (Picture mode)

Use this feature to select the video picture mode and adjust each mode to suit the video picture.

Manual Setup > Video > Picture Mode >

Choices: Cinema, Standard, Dynamic



- Select Cinema for movies.
- Select Standard for general video sources.
- Select Dynamic for encoded fully animated video sources, such as video games.

Choices: Enhancer (0 to +24), 3D NR (0 to +10), Brightness (-24 to +24), Contrast (-24 to +24), Saturation (-24 to +24), Reset

- 1) Press Δ/∇ to select the item you want to adjust, then press ENTER. The setting adjustment screen is displayed.



- 2) Use \leftarrow/\rightarrow to adjust the settings, then press ENTER

- Select Enhancer to adjust the sharpness.
- Select 3D NR to reduce the picture noise.
- Select Brightness to adjust the brightness.
- Select Contrast to adjust the contrast.
- Select Saturation to adjust the depth of color.
- Select Reset, then press \triangleright to cancel the picture adjustment.

Note

With some monitors, making extreme adjustments to several items may result in video distortion. In such cases, select Reset to cancel the picture adjustments and use the video adjustment features provided on your monitor.

Resolution (Resolution)

Use this feature to select the video resolution. This is the resolution of the output image when Processor is set to On.

Manual Setup > Video > Resolution

Choices: 480p/576p, **480i/576i**, 720p, 1080i



- Select 480p/576p to set the resolution to 480p/576p.
 - Select 480i/576i to set the resolution to 480i/576i.
 - Select 720p to set the resolution to 720p.*
 - Select 1080i to set the resolution to 1080i.*
- * Even if 720p or 1080i is selected, signals protected by copyright laws are output at 480p/576p.

Note

This setting is only possible for signals output to the COMPONENT VIDEO jacks.

■ Aspect (Aspect)

Use this feature to select the aspect ratio for the output image converted using the video processing circuit.

Manual Setup > Video > Aspect

Choices: **Through**, Auto, 16:9 Normal, 16:9 Zoom























- **Through:** Does not change the aspect ratio of the input video signal in any way.
- **Auto:** Automatically detects the aspect ratio of the input video signal and chooses the most appropriate setting automatically.
- **16:9 Normal:** Adds black bars to the left and right sides of the input video signal before outputting it to the TV. Use to watch 4:3 software on a 16:9 TV.
- **16:9 Zoom:** Cuts off the top and bottom of the input video signal before outputting it to the TV. Use to watch 4:3 letter boxed software on a 16:9 TV.

See Aspect conversion examples on the next page for details.

■ **Aspect conversion examples**

The images with bold outlines indicate the most suitable setting for each input signal/TV combination.

Input signal aspect ratio	TV type	Setting		
		Through	16:9 Normal	16:9 Zoom
4:3 	4:3			
	16:9			
4:3 (Letter box) 	4:3			
	16:9			
16:9 	4:3			
	16:9			

Note

If you want to watch 16:9 software on a 4:3 TV, you need to change the aspect ratio on your TV.

■ **Cross Color (Cross color)**

Use this feature to remove noise from the brightness of displayed images.

Manual Setup > Video > Cross Color

Choices: Not Suppress, **Suppress**



- Select Not Suppress if you do not want to adjust the brightness of displayed images.
- Select Suppress to remove noise from the brightness of displayed images.

■ **TV Format (TV format)**

Use this feature to select the video format for your TV.

Manual Setup > Video > TV Format

Choices: PAL, NTSC

Initial setting:

U.S.A., Canada, Korea and General models: NTSC

Europe, U.K., Australia and China: PAL



If no image signal is being input for the selected TV format, select the format for the signal currently being output. Because COMPONENT OUT relies on resolution settings, if Resolution is set to 480i/576i, the signal is output for NTSC at 480i and for PAL at 576i.

■ S Video (S Video)

Use this feature to match the video output to the input on your monitor. S1 allows you to automatically resize wide screen software compressed at 4:3 so that it is displayed at 16:9. S2 allows you to automatically resize letter box software so that it is displayed in wide screen mode in addition to the S1 functionality.

Manual Setup > Video > S Video

Choices: S, **S1**, S2



- Select S when connecting this unit to the S input terminal on your monitor.
- Select S1 when connecting this unit to the S or S1 video input terminals on your monitor.
- Select S2 when connecting this unit to the S2 video input terminals on your monitor.

Manual setup: Option

This menu adjusts the optional system settings.

- 1 Press TOP on the GUI remote control.**
- 2 Select Manual Setup, then press ▷.**
- 3 Select Option then press ▷.**



- 4 Select the desired parameters, then press ▷ to access and adjust.**
- 5 When finished adjusting parameters, press ENTER.**

■ **Surr.Initialize (Surround initialize)**

Use this feature to initialize the parameters for each sound field program within sound field program groups. When you initialize a sound field program group, all of the parameter values within that group revert to their initial settings.

Adjusted sound field parameter settings are displayed in blue.

Manual Setup > Option > Surr.Initialize

Choices: All, 1-11

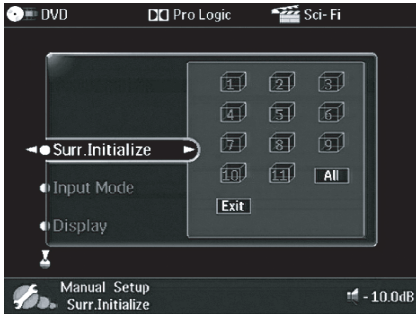

- Select All to initialize settings for all sound field program parameters.
- Select 1-11 to initialize individual sound field programs. Use the numeric keys on the remote control to select the sound field program you want to initialize, then press ENTER.
- Select EXIT, then press ENTER to exit this menu.

Note

Sound field program groups cannot be initialized when the Memory Guard Surr.Parameter is set to “Guard” (see page 78).

■ **Input Mode (Input mode)**

Use this feature to designate the input mode for sources connected to the DIGITAL INPUT jacks when you turn on this unit.

Manual Setup > Option > Input Mode



Choices: **Auto**, Last

- Select Auto if you want this unit to automatically detect input signal types and select the appropriate input mode.
- Select Last if you want this unit to automatically select the last input mode used for the connected source.

Note

Selecting Last does not recall the last setting for the EX/ES button.

■ Display (Display)

Use this feature to adjust the on-screen and front panel displays.

Manual Setup > Option > Display >



Wall Paper (Wallpaper)

Use this feature to select the background when no image is input from an external source. If you do not want to display the background, select None.

Choices: None, **1(DSP-Z9)**, 2(Horn), 3(Piano), 4(Gray)

Note

When Processor is set to Off in the Manual Setup menu, no background is displayed even if no image is input.

Position (Position)

Use to adjust the vertical and horizontal position of the GUI display.

Choices: +5 (downward/left) to -5 (upward/right)

- Press Δ to raise the position of the GUI display.
- Press ∇ to lower the position of the GUI display.
- Press \triangleright to shift the position of the GUI display to the right.
- Press \triangleleft to shift the position of the GUI display to the left.

On Screen (Text OSD on/off)

Use this feature to turn on/off the text information on-screen display.

Choices: Off, On

- Select Off to turn off the text information OSD.
- Select On to turn on the text information OSD.

Note

When Aspect is set to 16:9 Zoom (see page 73), the OSD is not displayed even if On Screen is set to On.

Dimmer (Dimmer)

Use to adjust the brightness of the front panel display.

Choices: -4 to 0

■ Multi Zone (Multi zone)

Use this feature to customize the Zone 2 and Zone B settings.

Manual Setup > Option > Multi Zone >

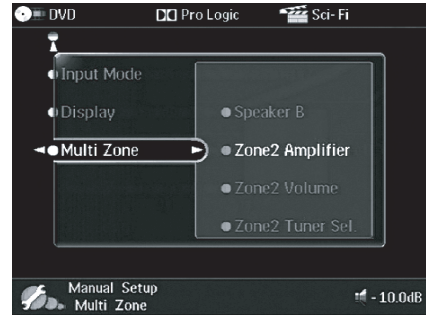

Speaker B (Speaker B)

Use this feature to select the location of the front speakers connected to the SPEAKERS B terminals.

Choices: Zone1, ZoneB

- Select Zone1 to turn on/off SPEAKERS A and B when the speakers connected to the SPEAKERS B terminals are set in the main room.
- Select ZoneB if the speakers connected to the SPEAKERS B terminals are set in another room. If SPEAKERS A is turned off and SPEAKERS B is turned on, all the speakers including the subwoofer in the main room are muted and the unit outputs sound from SPEAKERS B only.

Notes

- If you connect headphones to the PHONES jack on this unit, the sound is output from both the headphones and SPEAKERS B.
- When a DSP program is selected, the unit automatically enters the Virtual CINEMA DSP mode.

Zone2 Amplifier (Zone 2 Amplifier)

Use to select how the ZONE 2 speakers are amplified.

Choices: Internal, External, None

- Select External if you connect your Zone 2 speakers through an external amplifier connected to this unit's ZONE 2 OUTPUT jacks.
- Select Internal to use this unit's internal amplifier if you connect your Zone 2 speakers directly to this unit's PRESENCE/ZONE 2 speaker terminals.
- Select None if you do not want to use the Zone2 feature.

Note

When Internal is selected, the presence speaker setting automatically switches to None.

Zone2 Volume (Zone 2 volume)

Use to select how the volume control will operate with regard to the ZONE 2 OUTPUT jacks. When Zone2 Amplifier is set to Internal, this feature is automatically set to Variable.

Choices: Fixed, Variable

- Select Fixed to fix the ZONE 2 OUTPUT volume level to a standard line level.
- Select Variable to adjust the ZONE 2 OUTPUT volume simultaneously using VOL +/- on the remote control.

Zone2 Tuner Sel. (Zone 2 tuner select)

(U.S.A., Canada and Australia models only)

Use this feature to enable/disable the tuner function in Zone 2.

Choices: Enable, Disable

- Select Enable to use the tuner function in Zone 2.
- Select Disable if you do not want to use the tuner function in Zone 2.

Memory Guard

Use this feature to prevent accidental changes to individual parameter settings.

1 Press TOP on the GUI remote control.

2 Select Memory Guard, then press ▷.

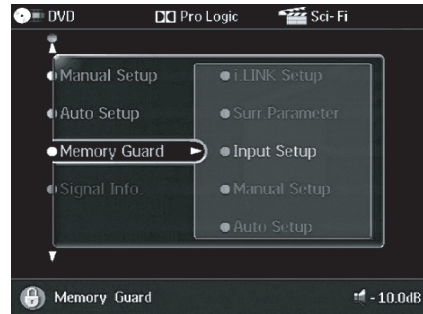

3 Select the desired parameters, then press ▷ to access and adjust.

■ **i.LINK Setup (i.LINK setup)**

Choices: Free, Guard

- Select Guard to prevent changes to the i.LINK parameters. Even when Guard is set, you can assign newly connected devices to the jacks on this unit if Plug & Play is set to ON (see page 99).
- Select Free to enable changes to the i.LINK parameters.

■ **Surr.Parameter (Surround parameter)**

Choices: Free, Guard

- Select Guard to prevent changes to the surround parameters.
- Select Free to enable changes to the surround parameters.

■ **Input Setup (Input setup)**

Choices: Free, Guard

- Select Guard to prevent changes to the input setup parameters.
- Select Free to enable changes to the input setup parameters.

■ Manual Setup (Manual setup)

Choices: Free, Guard

- Select Guard to prevent changes to the manual setup parameters. When Guard is set, you can select the Picture Mode (Cinema, Standard or Dynamic), but cannot adjust the settings of each mode.
- Select Free to enable changes to the manual setup parameters.

■ Auto Setup (Auto setup)

Choices: Free, Guard

- Select Guard to prevent changes to the auto setup parameters. Even when Guard is set, you can change the Distance unit.
- Select Free to enable changes to the auto setup parameters.

Note

In general, front panel and remote control operations are not affected by “Guard” functions. However, you cannot do the following:

- Adjust the tone control
- Switch the input mode
- Switch the text information display on/off using ON SCREEN on the remote control

REMOTE CONTROL FEATURES

In addition to controlling this unit, the remote control can also operate other A/V components made by YAMAHA and other manufacturers. To control other components, you must set up the remote control with the appropriate manufacturer code(s).

This remote control also has two other sophisticated features: learn and macro. The learn feature (LEARN) allows the remote to acquire functions from other remote controls equipped with an infrared remote control transmitter. The macro feature (MACRO) allows you to program a series of operations in sequence for single-button operation, or use the factory-set macros to operate other YAMAHA components.

Control area

■ Controlling this unit

The shaded area below can control this unit no matter which component control area is selected.

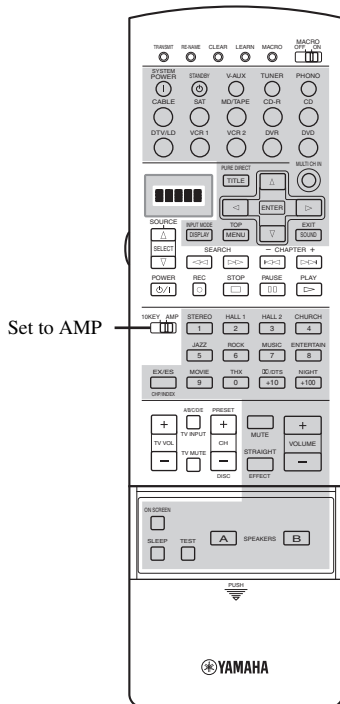

■ Controlling other components

The shaded areas below can be used to control other components. Each button has a different function depending on the selected component. Select the component you want to control by pressing an input selector button or SOURCE SELECT Δ/∇ . The name of the selected component appears in the display window.

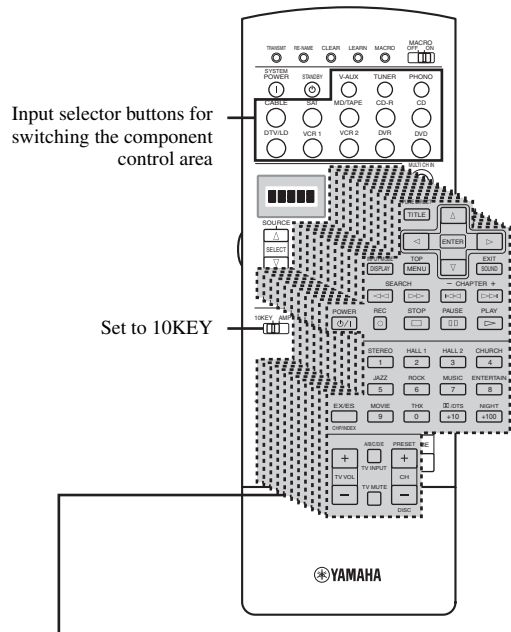

Component control area

You can control up to 13 different components by setting the appropriate manufacturer codes (see page 88).

Setting manufacturer codes

You can control other components by setting the appropriate manufacturer codes. Codes can be set for each input area.

The following table shows the input area (default component), component category (Library) and manufacturer code for each area.

Input area	Component category (Library)	Manufacturer code
V-AUX	VCR	-
TUNER	TUNER	YAMAHA 1
PHONO	TV	-
CABLE	CABLE	-
SAT	SAT	-
MD/TAPE	MD	YAMAHA 1
CD-R	CD-R	YAMAHA
CD	CD	YAMAHA 1
DTV/LD	TV	-
VCR 1	VCR	-
VCR 2	VCR	-
DVR	DVD	-
DVD	DVD	YAMAHA 1

Note

You may not be able to operate your YAMAHA component even if a YAMAHA manufacturer code is initially set as listed above. In this case, try to set another YAMAHA manufacturer code(s).

1 Press an input selector button to select the source component you want to set up.

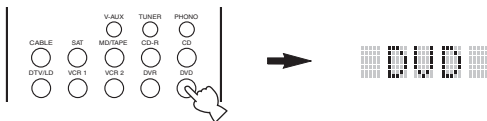

2 Press and hold LEARN for about 3 seconds using a ballpoint pen or similar object.

“SETUP” and the selected component name appear alternately in the display window.

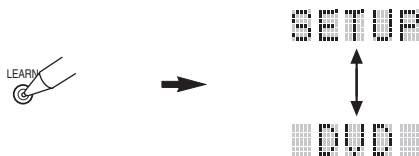

Be sure to press down LEARN for at least 3 seconds, otherwise the learning process will start.



Complete each of the following steps within 30 seconds. Otherwise, the learning mode is automatically canceled. In this case, press LEARN again.

If you want to change a library (component category), press \triangle/∇ to set a different component type.

Library choices: L:DVD, L:LD, L:CD, L:CDR, L:MD, L:TAP, L:TUN, L:AMP*, L:TV, L:CAB, L:DBS, L:SAT, L:VCR

* The amplifier Library (L:AMP) code is preset to “YPC” to operate this unit. However, you can switch between the following four codes if necessary.

- YPC To operate this unit (without ZONE 2 features).
- ZONE To operate this unit (with ZONE 2 features).
- DSP To operate YAMAHA DSP amplifiers that cannot be operated with the YPC code.
- NO To operate the amplifiers of other manufacturers using this unit’s remote control.

3 Press \triangle/∇ to select the name of your component’s manufacturer.

You will find the names of most worldwide audio-video manufacturers in alphabetical order in the display window.

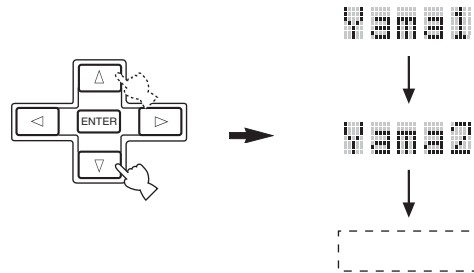

4 Press one of the buttons shaded below to see if you can control your component. If you can, the manufacturer code you set is correct.

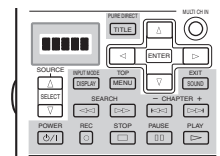

- If more than one code is listed for the manufacturer of your component, try each of them until you find the correct one.
- If you want to continue setting up a code for another component, press ENTER and repeat steps 1, 3 and 4.

5 Press LEARN again to exit from the setup mode.



Notes

- The supplied remote control does not contain all possible manufacturer codes for commercially available AV components (including YAMAHA AV components). If operation is not possible with any of the manufacturer codes, program the new remote control function with the Learn feature (see below) or use the remote control supplied with the component.
- If you have already programmed a remote control function for a button, the function by learning programming takes priority over the setup manufacturer code function.
- "ERROR" appears in the display window if you press a button not indicated in the respective step, or when you press more than one button at the same time.

Programming codes from other remote controls

If you want to program functions not included in the basic operations covered by the manufacturer code, or an appropriate manufacturer code is not available, do the following. You can program any of the buttons available in the component control area (see page 80). The buttons can be programmed independently for each component.

Note

This remote control transmits infrared rays. If the other remote control also uses infrared rays, this remote control can learn most of its functions. However, you may not be able to program some special signals or extremely long transmissions. (Refer to the operating instructions for the remote control of your component.)

1 Set 10KEY/AMP to 10KEY.



It is also possible to program in this unit's control area with 10KEY/AMP set to AMP. However, if you do this, you will not be able to control this unit and select sound field programs.

2 Press an input selector button to select a source component.



3 Place this remote control about 5 to 10 cm away from the remote control for your component on a flat surface so that their infrared transmitters are aimed at each other.

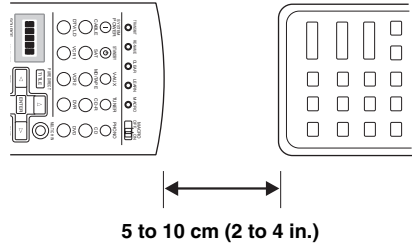

4 Press LEARN using a ballpoint pen or similar object.

Do not press and hold LEARN. If you hold down LEARN for more than 3 seconds, the remote control enters the manufacturer code setting mode.

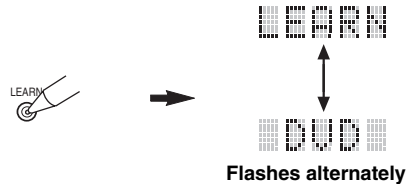

Complete each of the following steps within 30 seconds. Otherwise, the learning mode is automatically canceled. In this case, press LEARN again.

5 Press the button for which you want to program the new function.

"LEARN" is displayed.

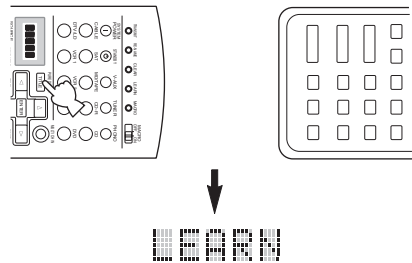

- 6** Press and hold the button you want to program on the remote control for your component until “OK” appears in the display window.

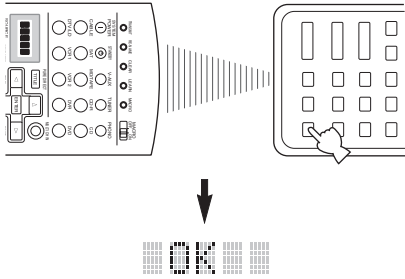

Notes

- “NG” appears in the display window if programming was unsuccessful. In this case, start over from step 5.
- This remote control can learn approximately 120 functions. However depending on the signals learned, “FULL” may appear in the display before you have programmed 120 functions. In this case, clear unnecessary programmed functions to make room for further learning.

- 7** Repeat steps 5 and 6 to program additional functions.

- 8** Press LEARN again to exit from the learning mode.



Notes

- Learning may not be possible in the following cases:
 - When the batteries in the remote control for this unit or other components are weak.
 - When the distance between the two remote controls is too great or too small.
 - When the remote control infrared windows are not aimed at an appropriate angle.
 - When the remote control is exposed to direct sunlight.
 - When the function to be programmed is continuous or uncommon.
- “ERROR” appears in the display window if you press more than one button at the same time.

Changing source names in the display window

You can change the name that appears in the display window on the remote control if you want to use a different name to the one that is factory preset. This is useful when you have set the input selector to control another component.

- 1** Press an input selector button to select the source component you want to rename.

The selected component name appears in the display window.



- 2** Press RE-NAME using a ballpoint pen or similar object.



- 3** Press Δ/∇ to select and enter a character.

Pressing ∇ changes the character as follows: A to Z, a to z, 0 to 9, space, -(hyphen), and /(slash). (Pressing Δ changes the characters in reverse order.)

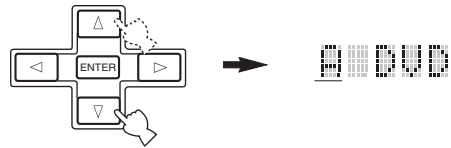

- 4** Press \leftarrow/\rightarrow to move the cursor to the next position.

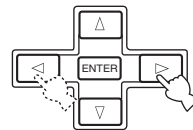

If you want to continue setting up names for other components, press ENTER and repeat steps 1, 3 and 4.

- 5** Press RE-NAME again to exit from the renaming mode.



Using the macro feature

The macro feature makes it possible to perform a series of operations with the press of a single button. For example, when you want to play a CD, normally you would turn on the components, select the CD input, and press the play button to start playback. The macro feature lets you perform all of these operations simply by pressing the CD macro button. The buttons listed as macro buttons below are factory set with macro programs. You can also program your own macros (see page 85).

Press a macro button



To automatically transmit these signals in order



(CD area)

Macro buttons		First	Second	Third	
SYSTEM POWER ①	➔		POWER (DTV/ LD area) ⓪/1	—	
V-AUX ○			V-AUX ○	—	
TUNER ○			TUNER (*3) ○	—	
PHONO ○			PHONO ○	—	
CABLE ○			CABLE ○	—	
SAT ○			SAT ○	—	
MD/TAPE ○			MD/TAPE ○	PLAY (MD/TAPE area) (*2) ▶	
CD-R ○			CD-R ○	PLAY (CD-R area) (*2) ▶	
CD ○			CD ○	PLAY (CD area) (*2) ▶	
DTV/LD ○			DTV/LD ○	—	
VCR 1 ○			VCR 1 ○	PLAY (VCR 1 area) (*2) ▶	
VCR2 ○			VCR2 ○	PLAY (VCR 2 area) (*2) ▶	
DVR ○			DVR ○	PLAY (DVR area) (*2) ▶	
DVD ○			DVD ○	PLAY (DVD area) (*2) ▶	
STANDBY ⓪			SYSTEM POWER ① (*1)	—	—

*1 You can turn on some components (including YAMAHA components) connected to this unit by connecting them to the AC OUTLET(S) on the rear panel of this unit. (Power control may not be synchronized with this unit depending on the component. For details, refer to the operation instructions for the connected component.)

*2 Playback can be started for any YAMAHA remote control-compatible MD recorder, CD player, CD recorder, DVD player, or LD player. When using macros to operate other components, you will need to program the PLAY button on the control area of that component (see pages 82 and 83) or set a manufacturer code (see page 81).

*3 When TUNER is selected as the input source, YAMAHA tuners will play the last station received before the unit was set to the standby mode.

Macro operations

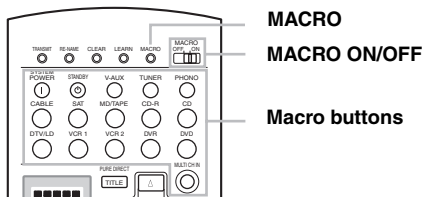

1 Set MACRO ON/OFF to ON.

2 Press a macro button.

Notes

- When you have finished using the macro feature, set MACRO ON/OFF to OFF.
- While the remote is carrying out a macro program, it will not accept any other button's function until the macro operation is complete (the TRANSMIT indicator stops flashing).
- Continue to aim the remote control at the component the macro is operating until the macro operation is complete.

Programming macro operations

You can program your own macros and use the macro feature to transmit several remote control commands in sequence at the press of a button. Be sure to set up manufacturer codes or perform learning operations before programming the macro. We do not recommend programming continuous operations such as volume control in a macro.

Notes

- The default macro is not cleared when a new macro is programmed for a button. The default macro can be used again when the programmed macro is cleared.
- It is not possible to add a new signal (macro step) to the default macro. Programming a macro changes all macro contents.

1 Press MACRO using a ballpoint pen or similar object.

"MCR ?" appears in the display window.



Complete each of the following steps within 30 seconds. Otherwise, the learning mode is automatically canceled. In this case, press MACRO again.

2 Press the macro button you want to use to operate the macro.

The macro button name and the selected component name appear alternately in the display window.

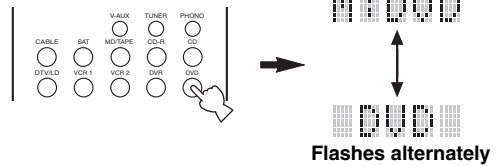

Notes

- "AGAIN" appears in the display window if you press a button other than a macro button.
- To change the selected source component, press SOURCE SELECT Δ/∇ . Pressing the input selector buttons will program a macro step, whereas SOURCE SELECT Δ/∇ only changes the selected component and corresponding component control area.

3 Press the buttons for the functions you want to include in the macro operation in sequence.

You can set up to 10 steps (10 functions). After you have set 10 steps, "FULL" appears and the remote control automatically exits from the macro mode.

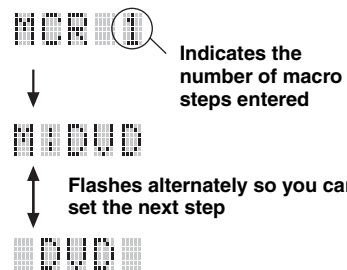
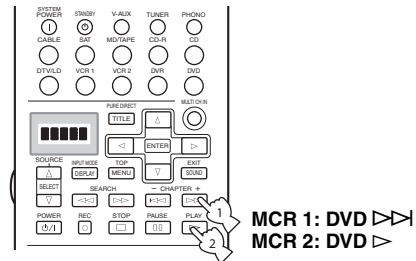

Note

"NG" appears in the display window if programming was unsuccessful. In this case, start over from step 2.

4 Press MACRO again when the operation sequence you want to program is complete.

Memory back-up

If the remote control is without batteries for more than 3 minutes, or if exhausted batteries remain in the remote control, the contents of the memory may be cleared. If the memory is cleared, insert new batteries, set up the manufacturer code(s) and program any acquired functions that may have been cleared.

Clearing function sets

You can clear all changes made in each function set, such as learned functions, macros, renamed component (source) names and setup manufacturer codes.

1 Press CLEAR by using a ballpoint pen or similar object.



Complete each of the following steps within 30 seconds. Otherwise, the learning mode is automatically canceled. In this case, press CLEAR again.

2 Press Δ/∇ to select the clear mode.

- L: DUD (L: name of a component)
Clears all learned functions for the respective component control area. Press an input selector button to select the component.
- L: AMP Clears all learned functions for this unit's control area.
- L: ALL Clears all learned functions.
- M: ALL Clears all programmed macros.
- RNAME Clears all renamed component (source) names.
- FCTRY Clears all remote functions and returns the remote to the factory settings.

3 Press and hold CLEAR again for about 3 seconds.

“C:OK” appears in the display window.

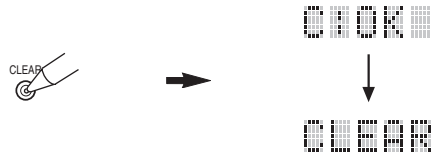

Note

“C:NG” appears in the display window if the operation was unsuccessful. In this case, start over from step 2.

4 Press CLEAR to exit the clear mode.

Once you have cleared a learned function or macro for a button, the button reverts to the factory setting.



Note

“ERROR” appears in the display window under the following circumstances:

- When a button other than a cursor or ENTER is pressed.
- When more than one button is pressed simultaneously.
- When MACRO ON/OFF or 10KEY/AMP is switched to another position.

Clearing individual functions

■ Clearing a learned function

You can clear the functions learned in programmed buttons for each area.

- 1 Press an input selector button to select the source component that contains the function you want to clear.

The selected component name appears in the display window.

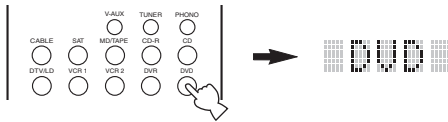

- 2 Press LEARN using a ballpoint pen or similar object.

“LEARN” and the selected component name appear alternately in the display window.

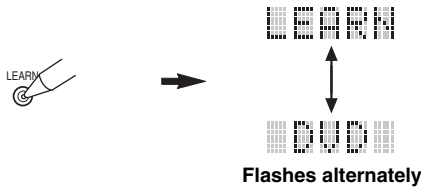

Complete each of the following steps within 30 seconds. Otherwise the learning mode is automatically canceled. In this case, press LEARN again.

- 3 Press and hold CLEAR using a ballpoint pen or similar object, then press the button you want to clear for about 3 seconds.

“C:OK” appears in the display window.

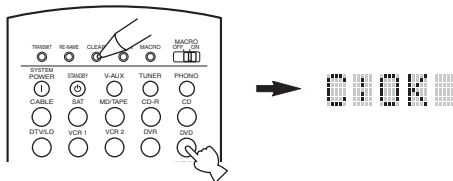

When you clear a learned function, the button reverts to the factory setting (or manufacturer setting if you have set manufacturer codes).

- 4 Repeat step 3 if you want to clear other learned functions.

- 5 Press LEARN to exit the clear mode.

■ Clearing macro functions

- 1 Press MACRO using a ballpoint pen or similar object.



Complete each of the following steps within 30 seconds. Otherwise the learning mode is automatically canceled. In this case, press MACRO again.

- 2 Press and hold CLEAR using a ballpoint pen or similar object, then press the macro button you want to clear for about 3 seconds. “C:OK” appears in the display window.

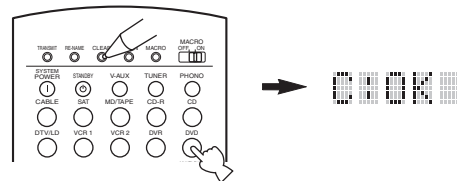

When you clear a macro, the button reverts to the factory setting (or manufacturer setting if you have set manufacturer codes).

- 3 Repeat step 2 if you want to clear other macro functions.

- 4 Press MACRO to exit the clear mode.



Controlling components

Once you set the appropriate manufacturer codes, you can use this remote to control your other components. Note that some buttons may not correctly operate the selected component. You can use the input selector buttons to select the component you want to operate and automatically switch the remote control to the appropriate control mode for that component.



- To control a component without changing this unit's input mode, use SOURCE SELECT Δ/∇ to select the component.
- TV VOL +/-, TV INPUT, and TV MUTE operate your TV without switching the input if the manufacturer code for your TV is set in the DTV/LD area. If a component other than TV is set in this area, you can control your TV by setting it in the PHONO area. If your TV is set in both the DTV/LD and PHONO areas, priority is given to the signal in the DTV/LD area.

Operating a DVD player (DVD and DVR areas)

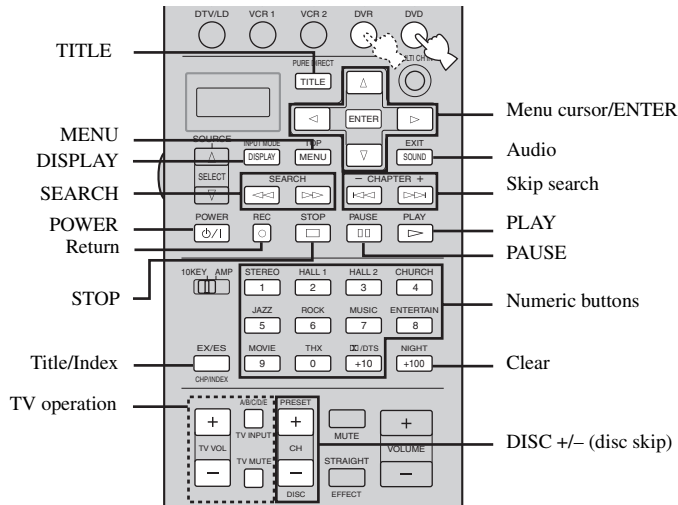

Operating a VCR or (VCR 1, VCR 2 and V-AUX areas)

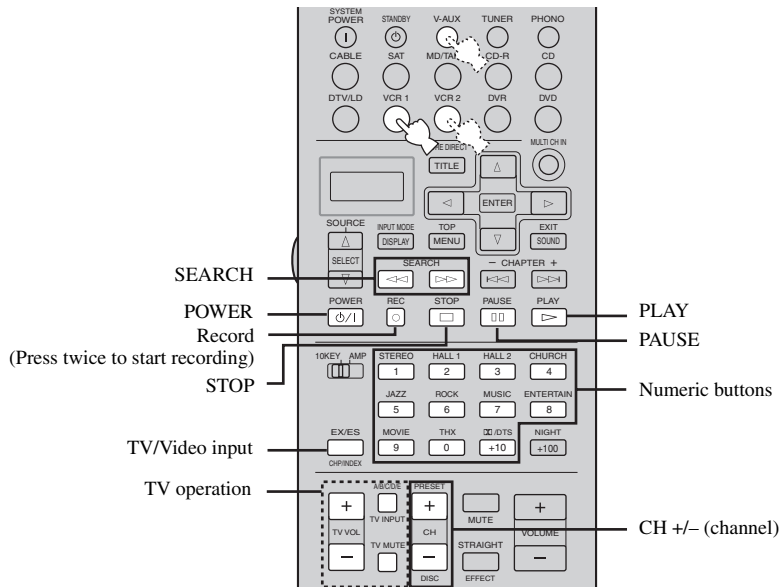

■ Operating a digital TV (DTV/LD area) or cable/satellite TV (CABLE or SAT areas)

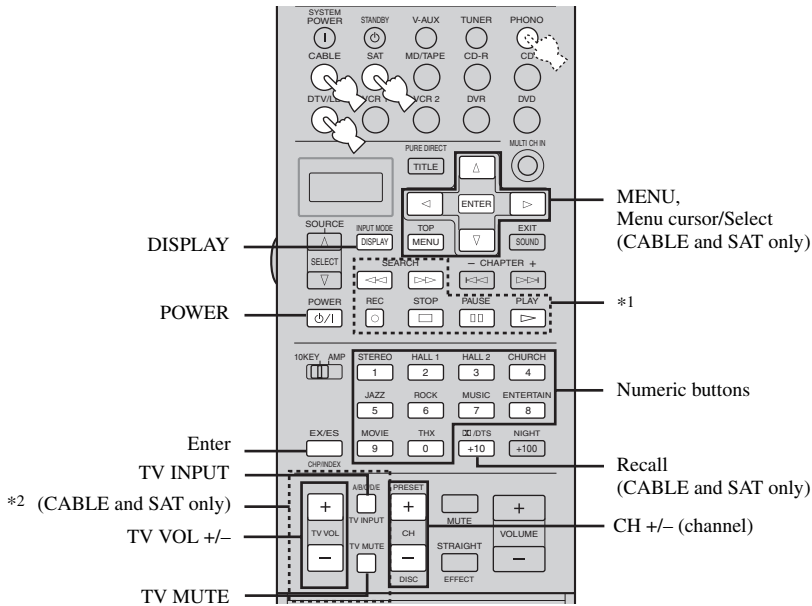

*1 SEARCH, REC, STOP, PAUSE and PLAY operate your VCR without switching the input to VCR 1 if the manufacturer code for your VCR is set in the VCR 1 area.

*2 TV VOL +/-, TV INPUT and TV MUTE operate your TV without switching the input if the manufacturer code for your TV is set in the DTV/LD area.

■ Operating an LD player

You need to set the manufacturer code for your LD player following the setting procedure described on page 81 because DTV/LD is factory-set to operate TVs.

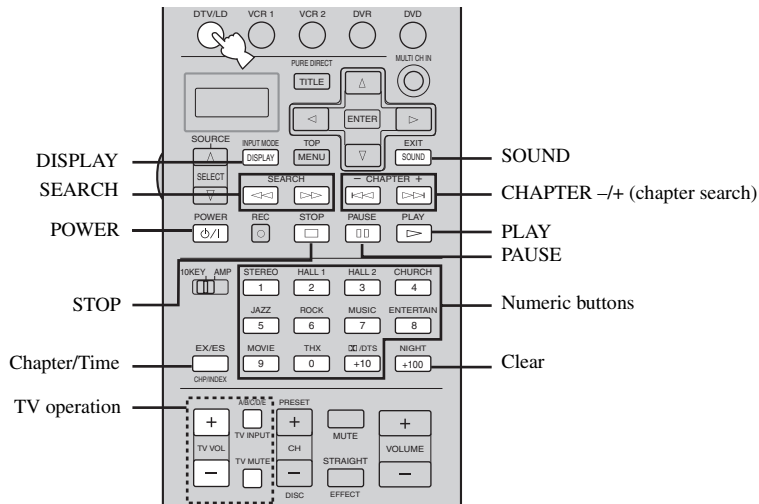

■ Operating a CD player (CD area)

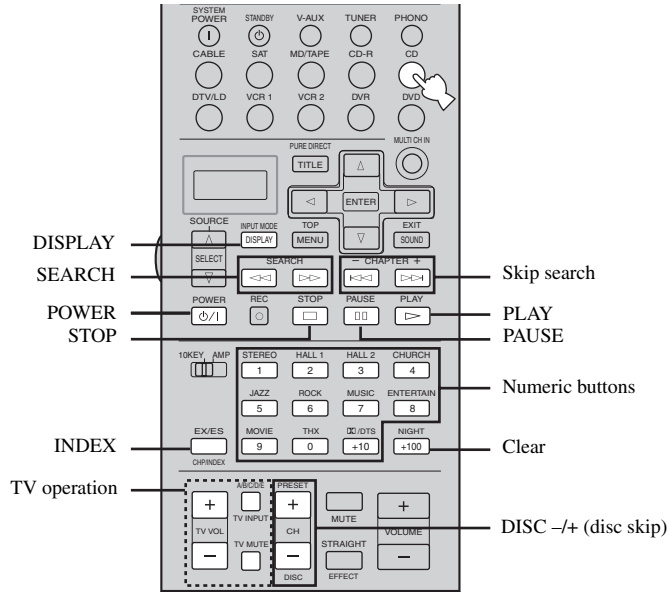

■ Operating a CD recorder (CD-R area) or MD recorder (MD/TAPE area)

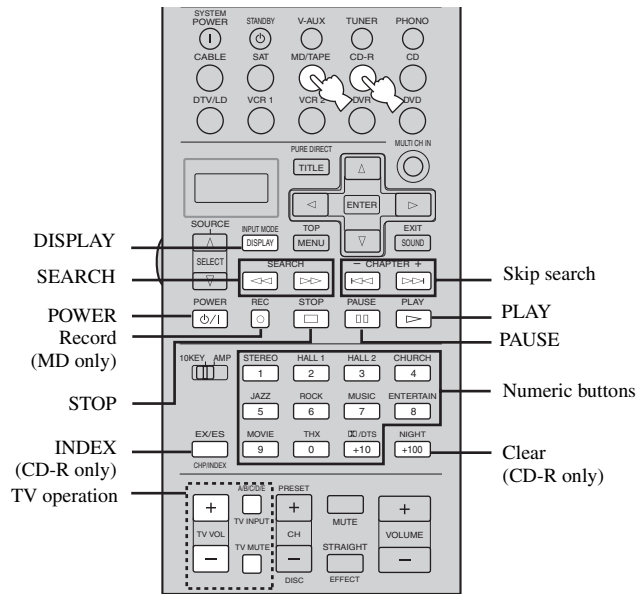

■ Operating a tape deck (MD/TAPE area)

You need to set the manufacturer code for your tape deck following the setting procedure described on page 81 because MD/TAPE is factory-set to operate MD decks.

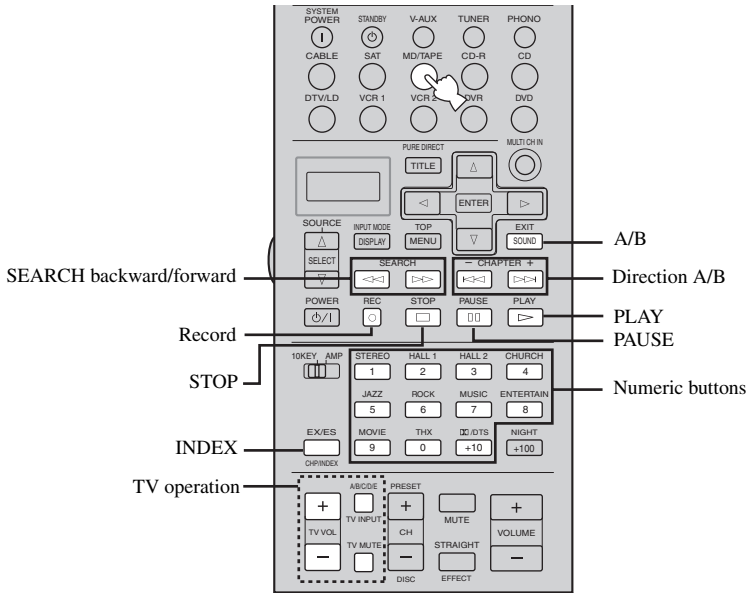

■ Operating a tuner (TUNER area)

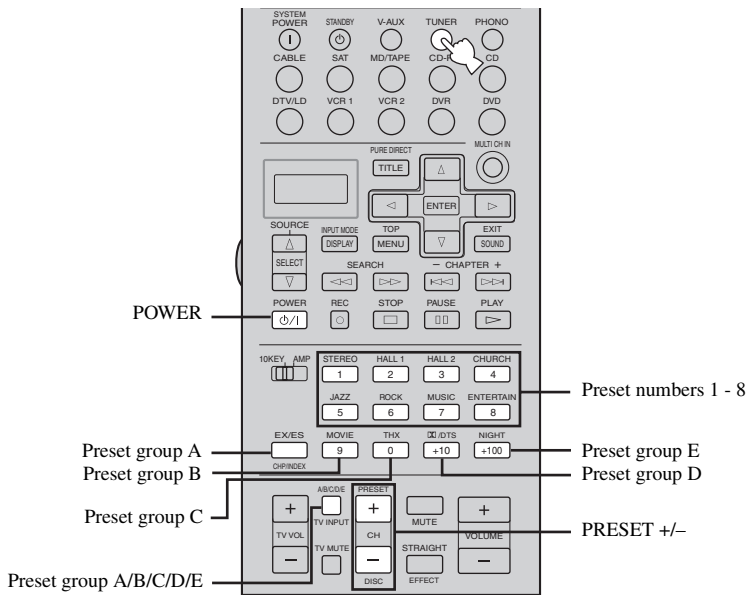

■ Operating optional components (OPTN area)

OPTN is an additional component control area that can be programmed with remote control functions independently from any input source.

Notes

- You cannot set a manufacturer code for this area. See page 82 to program buttons operated within this component control area.
- The OPTN area cannot be used when ZONE is selected in the amplifier Library (page 81).

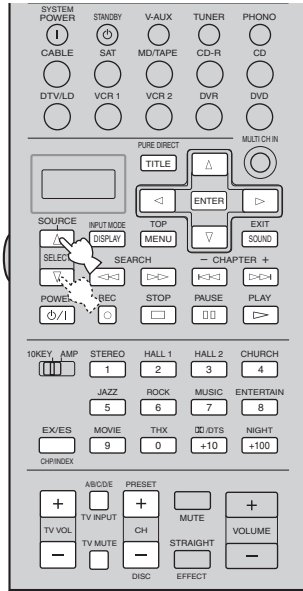

ZONE 2

This unit allows you to configure a multi-room audio-video system. The Zone 2 feature enables you to set this unit to reproduce separate input sources in the main room and second room (Zone 2) using the supplied remote control from the second room.

Zone 2 connections

You need the following additional equipment to use this unit's multi-room functions:

- An amplifier and speakers for the second room.
- A video monitor for the second room.

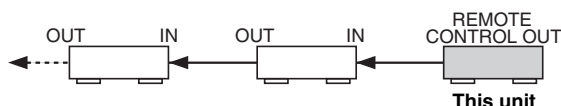

- Since there are a number of ways you can connect and use this unit in a multi-room installation, we recommend that you consult your nearest authorized YAMAHA dealer or service center for the Zone 2 connections that best meet your requirements.
- Some YAMAHA models are able to connect directly to this unit's REMOTE CONTROL OUT jack. If you own these types of products, you may not need to use an infrared emitter. Up to 6 YAMAHA components can be connected as shown here.

System configuration and connection example

Using external amplifiers

To use an external amplifier in Zone 2, select External in ZONE2 AMP.

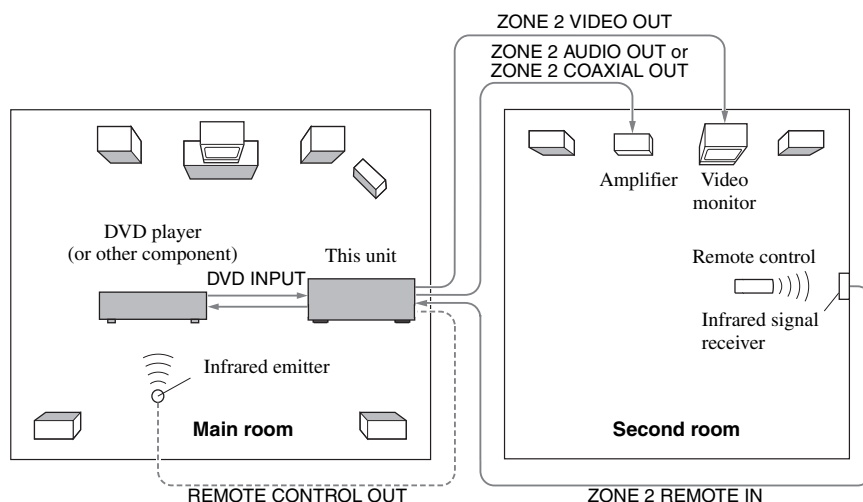

Notes

- When not using the main room, turn down the volume of this unit in the main room. Adjust the Zone 2 volume using the amplifier in the second room.
- To avoid unexpected noise, DO NOT USE the Zone 2 feature with CDs encoded in DTS.
- Dolby Digital RF signals and signals input through an i.LINK connection are not output from ZONE 2 COAXIAL OUT. Further, the Zone 2 volume setting does not apply to signals output from ZONE 2 COAXIAL OUT (i.e., input signals are output at the same volume they are input).

Using this unit's internal amplifier

To use this unit's internal amplifier, select ON in ZONE2 AMP.

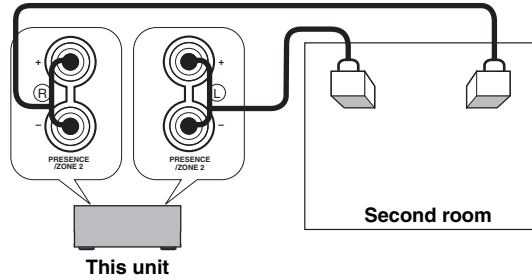

Remote controlling Zone 2

The supplied remote control can be used to control Zone 2. You can even select the input source and control components located in the main room directly from the second room regardless of the listening condition in the main room.

■ **To enable Zone mode on the remote control**

This allows you to switch the remote control mode from one room to another, and use STANDBY, SYSTEM POWER, MUTE, and VOLUME +/- to control the selected room.

- 1 Set REC OUT/ZONE 2 on the front panel to SOURCE/REMOTE.**

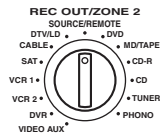

- 2 Repeat steps 1 and 2 of the procedure in "Setting manufacturer codes" on page 81.**

- 3 Press </> to select "L:AMP".**

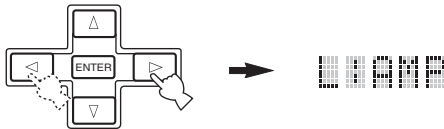

- 4 Press Δ to select "Zone".**

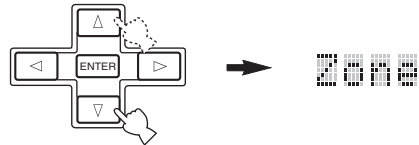

- 5 Press LEARN to complete the Zone setup.**
The remote control is able to operate this unit from Zone 2.



■ **To control Zone 2**

- 1 Press SOURCE SELECT Δ repeatedly to display "Zone 2" in the display window.**

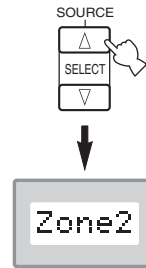

- 2 Press SYSTEM POWER to turn on the power for Zone 2.**

3 Press an input selector button to select the input source you want to listen to in the second room.

The display window shows “2: name of selected input”.

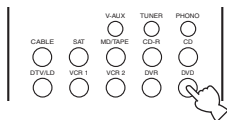

Note

Signals input to V-AUX and PHONO jacks cannot be sent to Zone 2.

4 You can control this unit from Zone 2 using the input selector, STANDBY, SYSTEM POWER, MUTE and VOLUME +/- buttons.

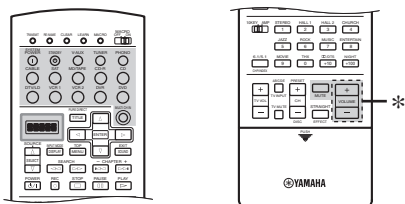

* VOLUME +/- can only be used when Variable is selected in Zone 2 Volume (see page 78). Further, you cannot adjust the volume of signals output from ZONE 2 COAXIAL OUT.

5 Press SOURCE SELECT Δ/∇ to exit from the Zone 2 mode.

Notes

- The source in Zone 2 and the source available for recording are always the same.
- “Zone 2” appears in the display window only when Δ is pressed, and SYSTEM only when ∇ is pressed.

Turning this unit to either on or standby
SYSTEM POWER and STANDBY work differently depending on the selected mode that appears on the display window.

- When the Normal or Zone2 mode is selected, you can turn the main unit or Zone 2 to on/standby individually.
- When the System mode is selected, or when YPC is selected as the amplifier library (L:AMP) code, you can turn the main unit and Zone 2 to on/standby simultaneously.

	LCD display	SYSTEM POWER/STANDBY
Normal mode*	Name of component	Turns the main unit to on/standby
Zone 2 mode	“Zone 2” or “2:name of component”	Turns Zone 2 to on/standby
SYSTEM mode	“SYSTEM”	Turns everything (the main unit and Zone 2) to on/standby

* “MAIN” appears for a few seconds when SYSTEM POWER or STANDBY is pressed.

Special considerations for DTS software

The DTS signal is a digital bitstream. If you attempt to send the DTS signal to the second room you will only hear digital noise (that may damage your speakers). Thus, the following considerations and adjustments need to be made when playing DTS encoded discs.

For LDs or DVDs encoded with DTS

Only 2 channel analog audio signals may be sent to the second/third room.

- for LDs: Set your LD player’s left and right outputs to the analog soundtrack.
- for DVDs: Use the disc menu to set the DVD player’s mixed 2-channel left and right audio outputs to the PCM or Dolby Digital soundtrack.

For CDs encoded in DTS

To avoid unexpected noise, DO NOT USE the Zone 2 feature with CDs encoded in DTS.

USING i.LINK

This unit is fitted with two i.LINK (AUDIO) connectors. By connecting components that support i.LINK (AUDIO) connections, in addition to digital transmission of 2-channel linear PCM signals and audio signals that have been compressed in multi-channel format, you can also send and receive uncompressed multi-channel audio signals, such as DVD audio and Super Audio CD signals for which digital transmission was not previously possible.

What is i.LINK?

i.LINK is a high-speed and bi-directional digital interface in compliance with the IEEE1394 international standard.

- This unit supports i.LINK (AUDIO) for digital transmission of conventional 2-channel PCM signals and compressed multi-channel audio signals, as well as DVD audio (multi-channel PCM) and Super Audio CD (DSD) multi-channel audio signals using a single IEEE1394 cable connected from an i-LINK (AUDIO)-compatible component.
- The i.LINK transmission format supports the A&M Protocol (Audio and Music Data Transmission Protocol).
- i.LINK supports transmission speeds up to S400.
- Because i.LINK supports DTCP (Digital Transmission Content Protection), digital audio signals can be transmitted without any degradation in signal quality.

This unit's i.LINK interface was based on the following design standards:

- IEEE Std 1394a-2000 (Standard for a High Performance Serial Bus)
 - Audio and Music Data Transmission Protocol 2.0
- This unit's i.LINK interface supports the following AM824 sequence adaptation layers: IEC60958 bitstream, DVD-Audio and Super Audio CD.

Connecting i.LINK components

You can connect i.LINK-compatible devices to this unit using either the daisy chain or tree connections.

■ Daisy chain connections

Use to link components together in a single chain. You can link up to 17 different components (including this unit) with this method.

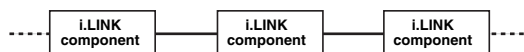

■ Tree connections

Use to link components in a branched configuration when 3 or more i.LINK connectors are available. You can link up to 63 different components (including this unit) with this method.

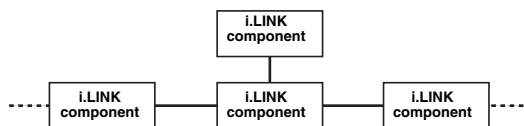

- When making connections, use a 4-pin IEEE1394 cable that supports the S400 transmission speed. We also recommend using a cable less than 3.0 m (12 ft) in length.
- This unit supports hot plugging, a function that allows you to disconnect or connect the IEEE1394 cable while the power is turned on.

Notes

- The system will not work if components are connected in a loop (where the output signal is returned to the original component). When connecting multiple i.LINK components, be sure not to connect them in a loop. If a loop connection is detected, the message "Loop Connection" is displayed on this unit's front panel display. If this happens, disconnect the IEEE1394 cable, and use a recommended connection method.
- Do not disconnect or connect the IEEE1394 cable from this unit or other i.LINK components while data is being transferred. Doing so may disrupt playback or cause noise.
- When connecting the IEEE1394 cable to this unit's i.LINK connectors, be sure to confirm the orientation of the connector before connecting the cable. Using excessive force to connect the cable to the connector in the wrong orientation will damage the connector.

Assigning i.LINK components

When an i.LINK component is connected, this unit automatically recognizes the connection and registers the connected component. Registered i.LINK components, such as CD or DVD players, can be assigned to a specific input. Assigning an i.LINK component to a specific input allows you to select the video input signals from that component together with the audio signals received via the i.LINK connection for simultaneous playback.

Notes

- If you connect an i.LINK component that does not support i.LINK (AUDIO), or an i.LINK component that does not support audio signal transmission, the connected component will be registered with this unit, but cannot be assigned to a specific input.
- i.LINK components without a vendor or model name, such as IEEE1394 repeater/hub, are not registered.

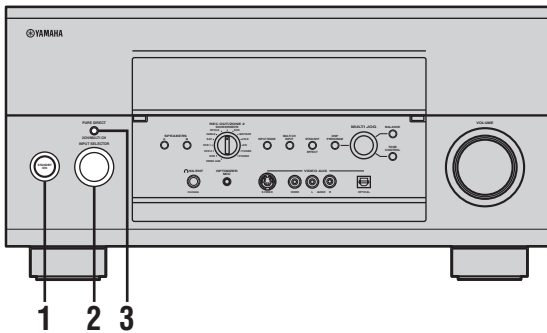

1 Turn on the power for this unit and the connected i.LINK component.

The i.LINK component is automatically recognized. "Link Check" flashes on the front panel display during this procedure.



After the i.LINK component is recognized, the name (model number) and name of the assigned input are displayed.

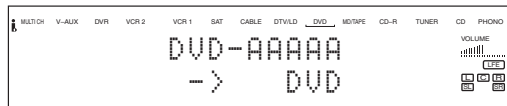

2 Rotate INPUT SELECTOR to select the input to which you want to assign the i.LINK component.

3 After selecting, press PURE DIRECT to complete the assignment.

If two or more i.LINK components are connected simultaneously, repeat steps 2 and 3 to assign input for the other i.LINK components.



- If you do not want to assign a specific input, select "MULTI CH" in step 2, then press PURE DIRECT. If you do this, the i.LINK component is assigned to MULTI CH INPUT. Even after you assign the i.LINK component to a specific input, you can still use MULTI CH INPUT to select i.LINK (AUDIO) components using INPUT SELECTOR.
- After recognition in step 1 is complete, the i.LINK component is automatically assigned to MULTI CH INPUT if no operation is performed within 10 seconds.
- You can change the input assignment using the i.LINK Select menu (see page 99).

Listening to playback from an i.LINK component

Perform the following steps to listen to playback from a registered i.LINK component.

If the i.LINK component has been assigned to a specific input

1 Rotate INPUT SELECTOR to select the input assigned to the i.LINK component.

2 Press INPUT MODE repeatedly to set "Auto" or "i.LINK" as the input mode.

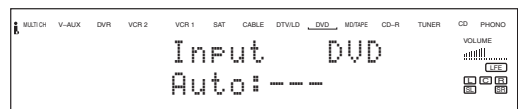

or



3 Start playback on the connected i.LINK component.

Refer to the operating instructions supplied with the component.

If MULTI CH INPUT is assigned for the i.LINK component

- 1 Press MULTI CH INPUT.**
- 2 Press INPUT MODE repeatedly to set "Auto" or "i.LINK" as the input mode.**



or



- 3 Start playback on the connected i.LINK component.**
Refer to the operating instructions supplied with the component.



If multiple i.LINK components are connected to this unit, rotate INPUT SELECTOR to select the desired i.LINK component after step 2.

Using the Auto Play function

If your i.LINK component supports automatic playback operations, you can use the auto play function. With auto play, you can select from the following two playback modes.

Auto play

When you select the i.LINK component using this unit's INPUT SELECTOR, playback from the selected i.LINK component begins automatically.

Auto operation

When you start playback on the i.LINK component, this unit automatically switches the input to select the i.LINK component.

Notes

- To set the playback mode, use "Auto Play" in the i.LINK Select menu (see page 99).
- Auto Play is not displayed when Input Mode is set to "Digital" or "Analog".

i.LINK indicator

Lights	This unit plays back signals input via i.LINK.
Flashes	An i.LINK component is connected, but this unit plays back signals input via sources other than i.LINK.
Goes out	No i.LINK component is connected.

Changing i.LINK Select parameters

Use this menu to display information about registered i.LINK components, delete any unused registered components, or customize the operation and playback settings to be used when this unit is connected to an i.LINK component.

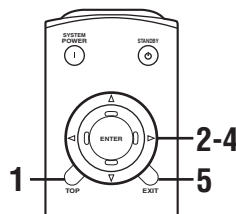

- 1 Press TOP on the GUI remote control.**
- 2 Select i.LINK Select, then press >.**



- 3 Press Δ/∇ repeatedly to select the parameter you want to adjust.**
- 4 Press ENTER or >, then press Δ/∇ repeatedly to change the setting of the item you want to adjust.**
- 5 Press EXIT.**

■ Information (Information)

Use this feature to display the following information: operation status of registered i.LINK devices, registered i.LINK devices that have been deleted, and i.LINK signals that are currently being received.

i.LINK Select > Information >

Choices: Details, Delete, Protect, i.LINK Status

- Select Details to display the following information about the selected i.LINK component.
 - **Vendor:** Displays the name of the manufacturer for your i.LINK component.
 - **Model:** Displays the model number for your i.LINK component.
 - **Active** (connected) or **Non Active** (not connected): Displays depending on whether your i.LINK component is connected.
 - **Audio** (for audio signals) or **Non Audio** (for non-audio signals): Displays depending on whether your i.LINK component supports audio signal playback.
 - **Assign:** Displays the name of the input assigned to the selected i.LINK component.
- Select Delete to delete the selected i.LINK component from the registered components list. To delete, press ENTER.



To delete all of the i.LINK components from the registered components list, set "All Delete" to Yes in the i.LINK Status screen and press ENTER.

Notes

- Select Protect to prevent the selected component from accidentally being deleted.
- Select i.LINK Status to display the number of i.LINK components registered, the number of i.LINK components currently connected to this unit, and the number of i.LINK components that can be deleted. If an error occurs while using an i.LINK component connected to this unit using an IEEE1394 cable, the contents of the error are displayed here.
- You cannot delete an i.LINK component while it is connected to this unit.

■ Select (Select)

Use this feature to select which registered i.LINK component's audio signal will be selected for playback.

i.LINK Select > Select

Select the name of the desired component and press ENTER to switch the input. When you select the desired component, its manufacturer and model information appear along with its input assignment at the right of the screen.

■ Plug & Play (Plug and play)

Use this feature to select whether you want the unit to automatically switch to the input assign mode when a new i.LINK component is connected.

i.LINK Select > Plug & Play

Choices: ON, OFF

- Select ON to display the input assign inquiry message and enter the input assign mode when a new i.LINK component is connected.
- Select OFF if you want MULTI CH INPUT to be assigned as the input without entering the input assign function when a new i.LINK component is connected.

■ Input Assign (Input assign)

Use this feature if you want to change the input assignment of a registered i.LINK component. You can select to assign the i.LINK component to any of the various inputs (PHONO to V-AUX) or MULTI CH INPUT.

i.LINK Select > Input Assign >

Choices: PHONO, TUNER, CD, CD-R, MD/TAPE, DVD, DTV/LD, CABLE, SAT, VCR 1, VCR 2, DVR, V-AUX, MULTI CH IN

1 Press Δ/∇ repeatedly to select the i.LINK component you want to assign, then press \triangleright .

2 Press Δ/∇ repeatedly to select the input for the i.LINK component, then press ENTER.

■ Auto Play (Auto Play)

Use this feature to turn on/off automatic playback when an i.LINK component is selected using INPUT SELECTOR, or select whether you want the input to switch automatically when an input stream from a connected i.LINK component is detected.

i.LINK Select > Auto Play

Choices: Z9 \rightarrow Player, Z9 \leftarrow Player, Z9 \leftrightarrow Player, Z9 \times Player

- Select Z9 \rightarrow Player if you want playback to start automatically on the i.LINK component selected using INPUT SELECTOR.
- Select Z9 \leftarrow Player if you want this unit to automatically switch its input to the i.LINK component which has started playing back.
- Select Z9 \leftrightarrow Player if you want both playback to start automatically on the i.LINK component selected using INPUT SELECTOR, and you want this unit to automatically switch its input to the i.LINK component which has started playing back.
- Select Z9 \times Player to disable automatic playback for the i.LINK components. This setting also prevents this unit from automatically switching its input to the i.LINK component.

i.LINK display messages

Status display messages

The following messages may appear on the front panel display depending on the status of this unit.

Message	Contents
Link Check	Appears while the i.LINK component connection is being checked.
No Name	Appears if the model name of the connected i.LINK component cannot be acquired.
No Vendor Name	Appears if the vendor name of the connected i.LINK component cannot be acquired.

Error messages

The following messages appear on the front panel display if a connection or registration error is detected.

Message	Cause	Remedy
Bus Full	The 1394 bus transmission band is full, and no more data can be transmitted.	This problem may be resolved by disconnecting any unused i.LINK components.
		If an i.LINK component with a slow transmission speed (S100 or S200) is connected between this unit and the i.LINK (AUDIO) component which you want to play back, the bus may become full. Changing the connection order of the i.LINK components so that this unit and the i.LINK (AUDIO) component are directly connected may resolve this problem.
Cannot Link	The connected i.LINK component is not recognized because the connection is incomplete.	Check that all i.LINK components are connected properly using an IEEE1394 cable.
Loop Connect	This unit and the i.LINK component are connected in a loop (where the output signal is returned to the original component).	Disconnect the IEEE1394 cable, then reconnect it in either a daisy chain or tree configuration.
Node Over	More than 63 i.LINK components (including this unit) are connected.	Reduce the number of connected components.
Hop Over	More than 15 i.LINK components are connected in a daisy chain configuration.	Reduce the number of i.LINK components connected between the two end components to 15 or less.
		Reconnect the i.LINK components using the tree-type connections.

SOUND FIELD OPTIONS

What is a sound field

What really creates the rich, full tones of a live instrument are the multiple reflections from the walls of the room. In addition to making the sound “live”, these reflections enable us to tell where the player is situated, and the size and shape of the room in which we are sitting.

■ Elements of a sound field

In any environment, in addition to the direct sound coming straight to our ears from the player’s instrument, there are two distinct types of sound reflections that combine to make up the sound field:

Early reflections

Reflected sounds reach our ears extremely rapidly (50 ms – 100 ms after the direct sound), after reflecting from one surface only — for example, from the ceiling or a wall. Early reflections actually add clarity to the direct sound.

Reverberations

These are caused by reflections from more than one surface — walls, ceiling, the back of the room — so numerous that they merge together to form a continuous sonic “afterglow”. They are non-directional, and lessen the clarity of the direct sound.

Direct sound, early reflections and subsequent reverberation taken together help us to determine the subjective size and shape of the room, and it is this information that the digital sound field processor reproduces in order to create sound fields.

If you could create the appropriate early reflections and subsequent reverberations in your listening room, you would be able to create your own listening environment. The acoustics in your room could be changed to those of a concert hall, a dance floor, or virtually any size room at all. This ability to create sound fields at will is exactly what YAMAHA has done with the digital sound field processor.

■ Sound field parameters (Stereo/Surround)

Use to select and adjust sound field parameters.

Item	Features	Page
DSP Level	Adjusts the level of all the DSP effect sounds.	103
Init. Delay	Adjusts the apparent distance from the source sound.	103
Room Size	Adjusts the apparent size of the sound field.	103
Liveness	Adjusts the reflectivity of the virtual walls in the hall.	104
Dialogue Lift	Adjusts the height of the front and center channel sounds.	104
Rev. Time	Adjusts the apparent size of the acoustic environment.	104
Rev. Delay	Adjusts the time difference between the beginning of the direct sound and the beginning of the reverberation sound.	105
Rev. Level	Adjusts the volume of the reverberation sound.	105
Sur. Delay	Adjusts the delay between the front (left, right and center) signals and the surround signals.	105
Initialize	Initializes the parameters of the sound field program.	105
Sur.Init.Delay	Adjusts the delay between the direct sound and the first reflection in the surround sound field.	105
Sur.Room Size	Adjusts the apparent size of the surround sound field.	105
Sur.Liveness	Adjusts the apparent reflectivity of the virtual walls in the surround sound field.	105
SB Init.Delay	Adjusts the delay between the direct sound and the first reflection in the surround back sound field.	105

Item	Features	Page
SB Room Size	Adjusts the apparent size of the surround back sound field.	105
SB Liveness	Adjusts the apparent reflectivity of the virtual wall in the surround back sound field.	105
Panorama	Extends the front stereo image to include the surround speakers for wraparound effect.	106
Center Width	Adjusts the center image from all three front speakers to varying degrees.	106
Dimension	Adjusts the sound field either towards the front or towards the rear.	106
Center Image	Adjusts the center image from all three front speakers to varying degrees.	106
Center Level	Adjusts the volume level of center channel in 9-channel stereo mode.	106
Surround L Level	Adjusts the volume level of surround left channel in 9-channel stereo mode.	106
Surround R Level	Adjusts the volume level of surround right channel in 9-channel stereo mode.	106
Sur.Back L Level	Adjusts the volume level of surround back left channel in 9-channel stereo mode.	106
Sur.Back R Level	Adjusts the volume level of surround back right channel in 9-channel stereo mode.	106
Sur.Back Level	Adjusts the volume level of surround back channel in 9-channel stereo mode.	106
Presence L Level	Adjusts the volume level of presence left channel in 9-channel stereo mode.	106
Presence R Level	Adjusts the volume level of presence right channel in 9-channel stereo mode.	106
Decode Type	Selects the decoder used to decode 2-channel sources into multi-channel using THX Cinema, Surround Enhanced, Surround Standard or Movie Theater programs.	107

Stereo/Surround menu

You can adjust the values of certain digital sound field parameters so that the sound fields are recreated accurately in your listening room. The following parameters are not always found in every program.

- 1 Press **TOP** on the GUI remote.
- 2 Select **Stereo/Surround**, then press **▷**.



- 3 Select the desired sound field program, then press **▷** to access and adjust.



■ DSP Level (DSP level)

This parameter adjusts the level of all DSP effect sounds within a narrow range. Depending on the acoustics of your listening room, you may want to increase or decrease the DSP effect level relative to the level of direct sound.

Control range: -6 dB – +3 dB

■ Init. Delay (Initial delay)

This parameter changes the apparent distance from the source sound by adjusting the delay between the direct sound and the first reflection heard by the listener. The smaller the value, the closer the sound source seems to the listener. The larger the value, the farther it seems. For a small room, set to a small value. For a large room, set to a large value.

Control range: 1 – 99 msec

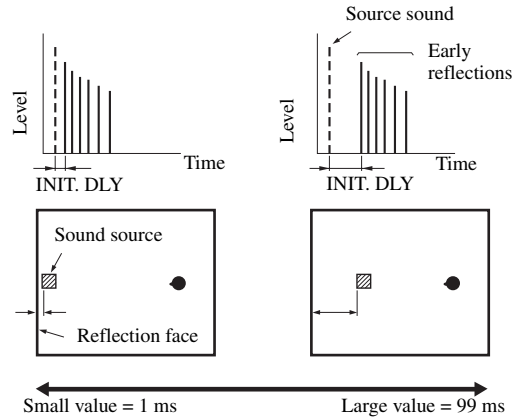

■ Room Size (Room size)

This parameter adjusts the apparent size of the sound field. The larger the value, the larger the sound field becomes. As sound is repeatedly reflected around a room, the larger that room is, the longer the time between the original reflected sound and the subsequent reflections. By controlling the time between the reflected sounds, you can change the apparent size of the virtual venue. Changing this parameter from one to two doubles the apparent length of the room.

Control range: 0.1 – 2.0

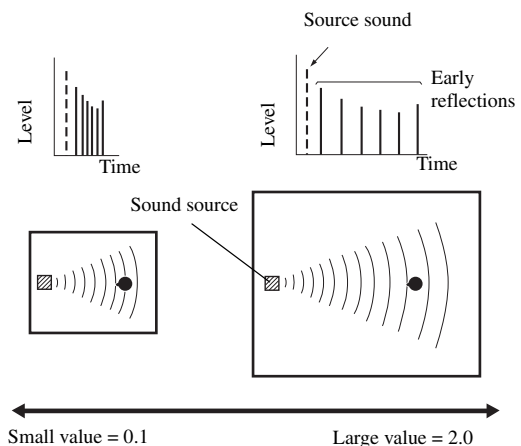

■ **Liveness (Liveness)**

This parameter adjusts the reflectivity of the virtual walls in the hall by changing the rate at which the early reflections decay. The early reflections of a sound source decay much faster in a room with acoustically absorbent wall surfaces than in one which has highly reflective surfaces. A room with acoustically absorbent surfaces is referred to as “dead”, while a room with highly reflective surfaces is referred to as “live”. The Liveness parameter lets you adjust the early reflection decay rate, and thus the “liveness” of the room.

Control range: 0 – 10

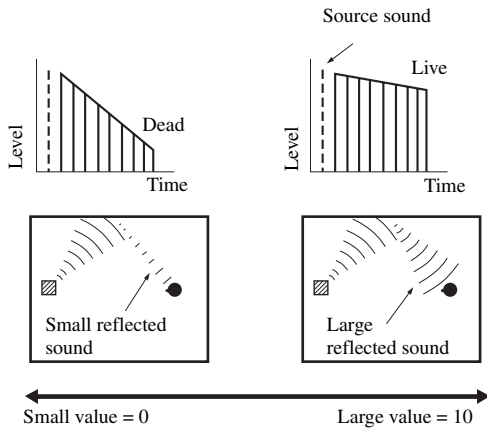

■ **Rev. Time (Reverberation time)**

This parameter adjusts the amount of time it takes for the dense, subsequent reverberation sound to decay by 60 dB (at 1 kHz). This changes the apparent size of the acoustic environment over an extremely wide range. Set a longer reverberation time for “dead” sources and listening room environments, and a shorter time for “live” sources and listening room environments.

Control range: 1.0 – 5.0 sec

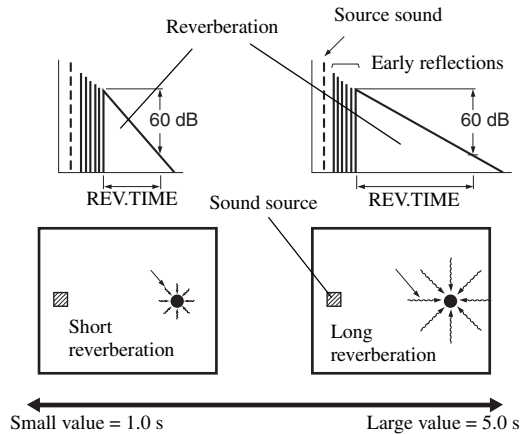

■ **Dialogue Lift (Dialog lift)**

This parameter adjusts the height of the front and center channel sounds by assigning some of the front and center channel elements to the presence speakers. The larger the parameter, the higher the position of the front and center channel sound.

Choices: 0, 1, 2, 3, 4, 5

■ Rev. Delay (Reverberation delay)

This parameter adjusts the time difference between the beginning of the direct sound and the beginning of the reverberation sound. The larger the value, the later the reverberation sound begins. A later reverberation sound makes you feel like you are in a larger acoustic environment.

Control range: 0 – 250 msec

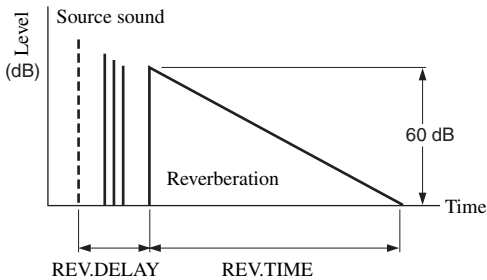

■ Rev. Level (Reverberation level)

This parameter adjusts the volume of reverberation sound. The larger the value, the stronger the reverberations become.

Control range: 0 – 100%

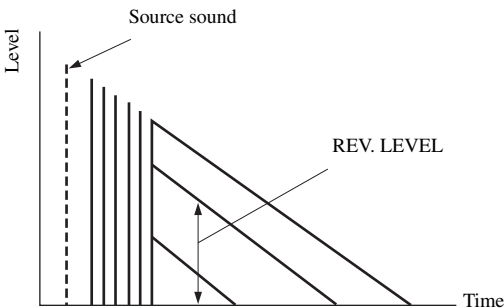

■ Sur. Delay (Surround delay)

This parameter adjusts the delay for surround signals and surround sound fields.

Control range: 0 – 15 msec

■ Initialize (Initialize)

This parameter initializes each sound field program.

Choices: YES, NO

■ Sur.Init.Delay (Surround initial delay)

This parameter adjusts the delay between the direct sound and the first reflection in the surround sound field.

Control range: 1 – 49 msec

■ Sur.Room Size (Surround room size)

This parameter adjusts the apparent size of the surround sound field.

Control range: 0.1 – 2.0

■ Sur.Liveness (Surround liveness)

This parameter adjusts the apparent reflectivity of the virtual walls in the surround sound field.

Control range: 0 – 10

■ SB Init.Delay (Surround back initial delay)

This parameter adjusts the delay between direct sound and the first reflection in the surround back sound field.

Control range: 1 – 49 msec

■ SB Room Size (Surround back room size)

This parameter adjusts the apparent size of the surround back sound field.

Control range: 0.1 – 2.0

■ SB Liveness (Surround back Liveness)

This parameter adjusts the apparent reflectivity of the virtual wall in the surround back sound field.

Control range: 0 – 10

For PRO LOGIC II Music

- **Panorama (Panorama)**

This parameter extends the front stereo image to include the surround speakers for wraparound effect.

Choices: OFF/ON, initial setting is OFF.

- **Center Width (Center width)**

This parameter adjusts the center image from all three front speakers to varying degrees. A larger value adjusts the center image towards the front left and right speakers. Control range: 0 (center channel sound is output only from the center speaker) to 7 (center channel sound is output only from the front left and right speakers), initial setting is 3.

- **Dimension (Dimension)**

This parameter gradually adjusts the sound field either towards the front or rear.

Control range: -3 (towards the rear) to +3 (towards the front), initial setting is STD (standard).

For DTS Neo:6 Music

- **Center Image (Center image)**

This parameter adjusts the center image from all three front speakers to varying degrees.

Control range: 0 – 1.0, initial setting is 0.3.

For 9ch Stereo

- **Center Level (Center level)**

This parameter adjusts the volume level for the center channel in 9-channel stereo mode.

Control range: 0 – 100%

- **Surround L Level (Surround left level)**

This parameter adjusts the volume level for the surround left channel in 9-channel stereo mode.

Control range: 0 – 100%

- **Surround R Level (Surround right level)**

This parameter adjusts the volume level for the surround right channel in 9-channel stereo mode.

Control range: 0 – 100%

- **Sur.Back L Level (Surround back left level)**

This parameter adjusts the volume level for the surround back left channel in 9-channel stereo mode.

Control range: 0 – 100%

- **Sur.Back R Level (Surround back right level)**

This parameter adjusts the volume level for the surround back right channel in 9-channel stereo mode.

Control range: 0 – 100%

- **Sur.Back Level (Surround back level)**

This parameter adjusts the volume level for the surround back channel in 9-channel stereo mode.

Control range: 0 – 100%

- **Presence L Level (Presence left level)**

This parameter adjusts the volume level for the presence left channel in 9-channel stereo mode.

Control range: 0 – 100%

- **Presence R Level (Presence right level)**

This parameter adjusts the volume level for the presence right channel in 9-channel stereo mode.

Control range: 0 – 100%

■ Decode Type (Decoder type)

For THX Cinema

Function: Selects the decoder used to playback 2-channel sources using THX Cinema.

Choices: Pro Logic / Pro Logic II / Pro Logic IIx / Neo:6

For Surround Enhanced

Function: Selects the decoder used to playback 2-channel sources using Surround Enhanced.

Choices: Pro Logic / Pro Logic II / Neo:6 / Pro Logic IIx

For Surround Standard

Function: Selects the decoder used to playback 2-channel sources using Surround Standard.

Choices: Pro Logic / PLII Movie / PLII Music / PLII Game / PLIIx Movie / PLIIx Music / PLIIx Game / Neo:6 Cinema / Neo:6 Music

For Movie Theater Programs

Function: Selects the decoder used to playback 2-channel sources using Movie Theater.

Choices: Pro Logic / Pro Logic II / Neo:6 / Pro Logic IIx

TROUBLESHOOTING

Refer to the chart below when this unit does not function properly. If the problem you are experiencing is not listed below, or if the remedy explanation does not help, set this unit to the standby mode, disconnect the power cord, and contact your nearest authorized YAMAHA dealer or service center.

■ General

Problem	Cause	Remedy	Refer to page
This unit fails to turn on when STANDBY/ON (or SYSTEM POWER) is pressed, or enters the standby mode soon after the power has been turned on.	The power cord is not connected or the plug is not inserted properly.	Connect the power cord firmly.	—
	The impedance setting is incorrect.	Set the impedance to match your speakers.	28
	The protection circuitry has been activated.	Make sure all speaker wire connections on this unit and all speakers are secure, and that the connection wires are not touching anything other than their respective connections.	13—15
	This unit has been exposed to a strong external electric shock (such as lightning or strong static electricity).	Set this unit in the standby mode, disconnect the power cord, plug it back in after 30 seconds, then use it as normal.	—
No sound	The input or output cable connections are incorrect.	Connect the cables properly. If the problem persists, the cables may be defective.	17—26
	The optimizer microphone is connected.	Disconnect the optimizer microphone.	31
	The input mode setting is incorrect.	Select a different input mode.	44
	No appropriate input source has been selected.	Select an appropriate input source using INPUT SELECTOR, MULTI CH INPUT or the input selector buttons.	37
	Speaker connections are not secure.	Secure the connections.	13
	The front speakers have not been selected properly.	Select the front speakers you want to use with SPEAKERS A and/or B.	37
	The volume is turned down.	Turn up the volume.	—
	The sound is muted.	Press MUTE or any operation button on this unit to cancel mute and adjust the volume.	38
	The signals this unit cannot reproduce are being received from a source component e.g.: a CD-ROM.	Play a source whose signals this unit can reproduce.	—

Problem	Cause	Remedy	Refer to page
The sound suddenly goes off.	The protection circuitry has been activated due to a short circuit, etc.	Check that the correct impedance is set.	28
		Check that the speaker wires are not touching each other and then turn this unit back on.	—
	The sleep timer has turned the unit off.	Turn on the power, and playback the source again.	—
	The sound is muted.	Press MUTE or any operation button on this unit to cancel mute and adjust the volume.	38
The speaker on one side only can be heard.	The cable connections are incorrect.	Connect the cables properly. If the problem persists, the cables may be defective.	13
	The balance settings are incorrect.	Adjust the Speaker Level settings.	69
No sound from the effect speakers.	The sound field programs are turned off.	Press STRAIGHT/EFFECT to turn them on.	42
	A Dolby Surround, Dolby Digital or DTS decoding DSP program is being used with material not encoded with Dolby Surround, Dolby Digital or DTS.	Select another sound field program.	39
	A sampling digital signal of 96 kHz or higher is being input to this unit.		
No sound from the center speaker.	The output level of the center speaker is set to minimum.	Raise the level of the center speaker.	69
	“Center” is set to None in Speaker Set.	Select the appropriate mode for your center speaker.	67
	One of the Hi-Fi DSP programs (except for 9ch Stereo) has been selected.	Select another sound field program.	39
No sound from the surround speakers.	The output level of the surround speakers is set to minimum.	Raise the output level of the surround speakers.	69
	“Surround” is set to None in Speaker Set.	Select the appropriate speaker mode for the surround L/R speakers.	68
	A monaural source is being played with STRAIGHT/EFFECT set to STRAIGHT.	Press STRAIGHT/EFFECT to turn on the sound fields. Then select another sound field program.	—
No sound from the surround back speakers.	“Surround” is set to None in Speaker Set.	If the speaker mode for the surround L/R speakers is set to None, the speaker mode for the surround back speaker is automatically set to None. Select the appropriate speaker mode for the surround L/R speaker mode.	68
	“Surround Back” is set to None in Speaker Set.	Select Large or Small.	68
No sound from the subwoofer.	“Bass Out” is set to Front in Subwoofer Set when a Dolby Digital or DTS signal is being played.	Select SWFR or Both.	67
	“Bass Out” is set to SWFR or Front in Subwoofer Set when a 2-channel source is being played.	Select Both.	67
	The source does not contain low bass signals.		

Problem	Cause	Remedy	Refer to page
Dolby Digital or DTS sources cannot be played. (The Dolby Digital or DTS indicator on the front panel display does not light up.)	The connected component is not set to output Dolby Digital or DTS digital signals.	Make an appropriate setting following the operating instructions for your component.	—
	The input mode is set to Analog.	Change the input mode setting to Auto or DTS.	44
A “humming” sound can be heard.	The cable connections are incorrect.	Firmly connect the audio plugs. If the problem persists, the cables may be defective.	—
	The turntable is not connected to the GND terminal.	Connect the grounding cord of your turntable to this unit’s GND terminal.	24
The volume level is low while playing a record.	The record is being played on a turntable with an MC cartridge.	The turntable should be connected to this unit through an MC-head amplifier.	24
The volume level cannot be increased, or sound is distorted.	The component connected to this unit’s OUT (REC) jacks is turned off.	Turn on the power to the component.	—
The sound effect cannot be recorded.	It is not possible to record sound effects with a recording component.		
A source cannot be recorded by a digital recording component connected to this unit’s DIGITAL OUTPUT jack.	The source component is not connected to this unit’s DIGITAL INPUT jacks.	Connect the source component to the DIGITAL INPUT jacks.	17—25
	Some components cannot record the Dolby Digital or DTS sources.		
A source cannot be recorded by an analog component connected to this unit’s AUDIO OUT jacks.	The source component is not connected to this unit’s analog AUDIO input jacks.	Connect the source component to the analog AUDIO input jacks.	17—25
The sound field parameters and some other settings on this unit cannot be changed.	Memory Guard is set to Guard.	Select Free to enable changes to the sound field parameters.	78
This unit does not operate properly.	The internal microcomputer has been frozen by an external electric shock (such as lightning or excessive static electricity) or by a power supply with low voltage.	Disconnect the AC power cord from the outlet and then plug it in again after about 30 seconds.	—
“CHECK SP WIRES” appears on the front panel display.	The speaker cables have short-circuited.	Make sure all speaker cables are connected correctly.	13

Problem	Cause	Remedy	Refer to page
There is noise interference from digital or high-frequency equipment, or this unit.	This unit is too close to digital or high-frequency equipment.	Move this unit further away from such equipment.	—
The picture is disturbed.	The video source uses scrambled or encoded signals to prevent dubbing.	Playing back video software that has an anti-copy signal or video signals with a lot of noise may produce unstable images.	—
This unit suddenly switches to the standby mode.	The internal temperature has become too high and the overheat protection circuitry activated.	Wait until this unit cools down and then turn it back on.	—
Monitor output fails.	The wrong TV format is set.	Press and hold down EXIT on the remote control for 5 seconds or longer to initialize Video settings.	71

■ Remote control

Problem	Cause	Remedy	Refer to page
The remote control does not work or function properly.	The remote control is being used at the wrong distance or angle.	The remote control will function within a maximum range of 6 m (20 ft) at no more than 30 degrees off-axis from the front panel.	9
	Direct sunlight or lighting (from an inverter type fluorescent lamp, etc.) is striking this unit's remote control sensor.	Reposition this unit.	—
	The batteries are weak.	Replace all batteries.	4
	The manufacturer code was not set correctly.	Set the manufacturer code correctly.	81
		Try setting another code for the same manufacturer.	81
Even if the manufacturer code is correctly set, there are some models that do not respond to the remote control.	Program the necessary functions independently for the programmable buttons using the learn feature.	82	
The remote control does not "learn" new functions.	The batteries of this remote control and/or the remote control for your component are too weak.	Replace the batteries.	4
	The distance between the two remote controls is too long or too short.	Place the remote controls at the proper distance.	82
	Signal coding or modulation of the remote control for your component is not compatible with this remote control.	Learning is not possible.	—
	Memory capacity is full.	Delete unnecessary functions to make room for new functions.	86, 87

PARAMETRIC EQUALIZER INFORMATION

This unit employs YAMAHA Parametric Room Acoustic Optimizer (YPAO) technology to optimize the frequency characteristics of its parametric equalizer to match your listening environment. YPAO uses a combination of the following three parameters (Frequency, Level and Q factor) to provide highly precise adjustment of the frequency characteristics.

■ Frequency

This parameter is adjustable in one-third octave increments between 63 Hz and 16 kHz.

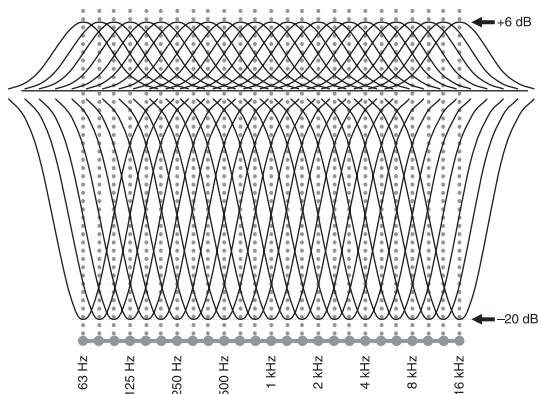

■ Level

This parameter is adjustable in increments of 0.5 dB between -20 and +6 dB.

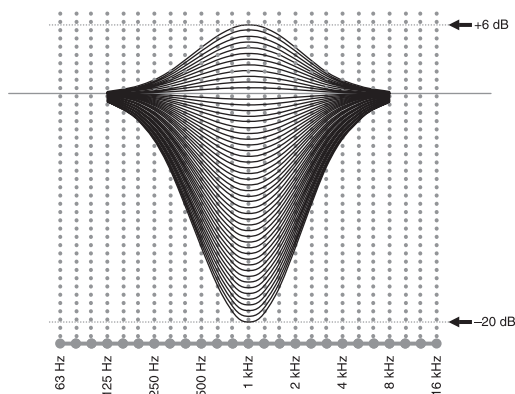

■ Q factor

The width of the specified frequency band is referred to as the Q factor. This parameter is adjustable between the values 0.5 and 10.

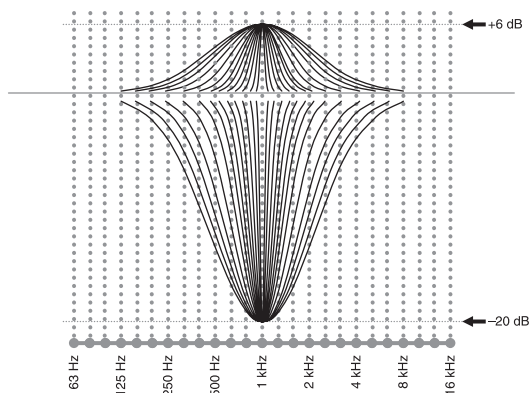

YPAO adjusts frequency characteristics to suit your listening requirements using a combination of the above three parameters (Frequency, Level and Q factor) for each equalizer band in this unit's parametric equalizer. This unit has 10 equalizer bands for each channel (plus 5 subwoofer bands).

The use of multiple equalizer bands enables more precise adjustments of frequency characteristics (as in Figure 2). This is not possible using only a single equalizer band (as in Figure 1).

Figure 1

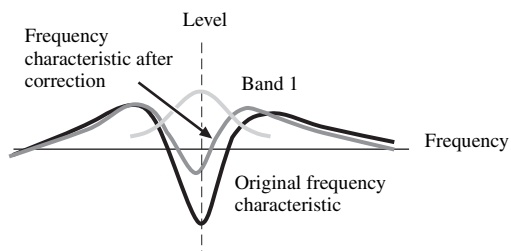
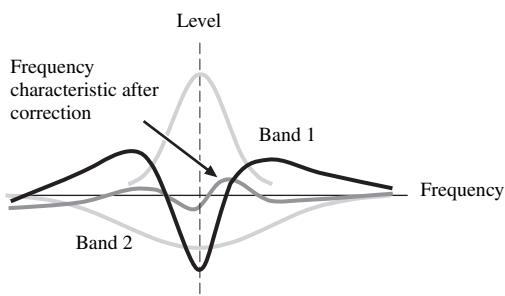

Figure 2



GLOSSARY

■ Dolby Surround

Dolby Surround uses a 4 channel analog recording system to reproduce realistic and dynamic sound effects: 2 front left and right channels (stereo), a center channel for dialog (monaural), and a surround channel for special sound effects (monaural). The surround channel reproduces sound within a narrow frequency range.

Dolby Surround is widely used with nearly all video tapes and laser discs, and in many TV and cable broadcasts as well. The Dolby Pro Logic decoder built into this unit employs a digital signal processing system that automatically stabilizes the volume on each channel to enhance moving sound effects and directionality.

■ Dolby Digital

Dolby Digital is a digital surround sound system that gives you completely independent multi-channel audio. With 3 front channels (left, center, and right), and 2 surround stereo channels, Dolby Digital provides 5 full-range audio channels. With an additional channel especially for bass effects, called LFE (low frequency effect), the system has a total of 5.1 channels (LFE is counted as 0.1 channel). By using 2-channel stereo for the surround speakers, more accurate moving sound effects and surround sound environment are possible than with Dolby Surround. The wide dynamic range (from maximum to minimum volume) reproduced by the 5 full-range channels and the precise sound orientation generated using digital sound processing provide listeners with previously unheard of excitement and realism.

With this unit, any sound environment from monaural up to a 5.1-channel configuration can be freely selected for your enjoyment.

Dolby Digital EX creates 6 full-bandwidth output channels from 5.1-channel sources. This is done using a matrix decoder that derives 3 surround channels from the 2 in the original recording. For the best results, Dolby Digital EX should be used with movie sound tracks recorded with Dolby Digital Surround EX. With this additional channel, you can experience more dynamic and realistic moving sound especially with scenes with “flyover” and “fly-around” effects.

■ Dolby Pro Logic II

Dolby Pro Logic II is an improved technique used to decode vast numbers of existing Dolby Surround software. This new technology enables a discrete 5-channel playback with 2 front left and right channels, 1 center channel, and 2 surround left and right channels (instead of only 1 surround channel for conventional Pro Logic technology). The Music and Game modes are also available for 2-channel sources in addition to the movie mode.

■ Dolby Pro Logic IIx

Dolby Pro Logic IIx is a new technology enabling discrete 7.1-channel playback from 2-channel or multi-channel sources. There is a Music mode for music, a Movie mode for movies and a Game mode for games.

■ DTS (Digital Theater Systems) Digital Surround

DTS digital surround was developed to replace the analog soundtracks of movies with a 6-channel digital sound track, and is now rapidly gaining popularity in movie theaters around the world. Digital Theater Systems Inc. has developed a home theater system so that you can enjoy the depth of sound and natural spatial representation of DTS digital surround in your home. This system produces practically distortion-free 6-channel sound (technically, left, right and center channels, 2 surround channels, plus an LFE 0.1 channel as a subwoofer, for a total of 5.1 channels). The unit incorporates DTS-ES decoder that enables 6.1- channel reproduction by adding the surround back channel to existing 5.1-channel format.

■ DTS 96/24

DTS 96/24 offers an unprecedented level of audio quality for multi-channel sound on DVD-Video, and is fully backward-compatible with all DTS decoders. “96” refers to a 96 kHz sampling rate (compared to the typical 48 kHz sampling rate). “24” refers to 24-bit word length. DTS 96/24 offers sound quality transparent to the original 96/24 master, and 96/24 5.1-channel sound with full-quality full-motion video for music programs and motion picture soundtracks on DVD-video.

■ Neo:6

Neo:6 decodes the conventional 2-channel sources for 6 channel playback by the specific decoder. It enables playback with the full-range channels with higher separation just like digital discrete signal playback. Two modes are available; "Music mode" for playing music sources and "Cinema mode" for movies.

■ LFE 0.1 channel

This channel is for the reproduction of low bass signals. The frequency range for this channel is 20 Hz to 120 Hz. This channel is counted as 0.1 because it only enforces a low frequency range compared to the full-range reproduced by the other 5/6 channels in a Dolby Digital or DTS 5.1/6.1 channel systems.

■ CINEMA DSP

Since the Dolby Surround and DTS systems were originally designed for use in movie theaters, their effect is best felt in a theater having many speakers and designed for acoustic effects. Since home conditions, such as room size, wall material, number of speakers, and so on, can differ so widely, it's inevitable that there are differences in the sound heard as well. Based on a wealth of actually measured data, YAMAHA CINEMA DSP uses YAMAHA original sound field technology to combine Dolby Pro Logic, Dolby Digital and DTS systems to provide the visual and audio experience of movie theater in the listening room of your own home.

■ SILENT CINEMA DSP

YAMAHA has developed a natural, realistic sound effect DSP algorithm for headphones. Parameters for headphones have been set for each sound field so that accurate representations of all the sound field programs can be enjoyed on headphones.

■ Virtual CINEMA DSP

YAMAHA has developed a Virtual CINEMA DSP algorithm that allows you to enjoy DSP sound field surround effects even without any surround speakers by using virtual surround speakers. It is even possible to enjoy Virtual CINEMA DSP using a minimal two-speaker system that does not include a center speaker.

■ Composite Video signal

With the composite video signal system, the video signal is composed of three basic elements of a video picture; color, brightness and synchronization data. A composite video jack on a video component transmits these three elements combined.

■ S VIDEO signal

With the S VIDEO signal system, the video signal normally transmitted using a pin cable is separated and transmitted as the Y signal for the luminance and the C signal for the chrominance through the S VIDEO cable. Using the S VIDEO jack eliminates video signal transmission loss and allows recording and playback of even more beautiful images.

■ Component video signal

With the component video signal system, the video signal is separated into the Y signal for the luminance and the Pb and Pr signals for the chrominance. Color can be reproduced more faithfully with this system because each of these signals is independent. The component signal is also called the "color difference signal" because the luminance signal is subtracted from the color signal. A monitor with component input jacks is required in order to use the component signal for output.

■ PCM (Linear PCM)

Linear PCM is a signal format under which an analog audio signal is digitized, recorded and transmitted without using any compression. This is used as a method of recording CDs and DVD audio. The PCM system uses a technique for sampling the size of the analog signal per very small unit of time. Standing for "pulse code modulation", the analog signal is encoded as pulses and then modulated for recording.

■ Sampling frequency and number of quantized bits

When digitizing an analog audio signal, the number of times the signal is sampled per second is called the sampling frequency, while the degree of fineness when converting the sound level into a numeric value is called the number of quantized bits.

The range of rates that can be played back is determined based on the sampling rate, while the dynamic range representing the sound level difference is determined by the number of quantized bits. In principle, the higher the sampling frequency, the wider the range of frequencies that can be played back, and the higher the number of quantized bits, the more finely the sound level can be reproduced.

■ THX Cinema processing

THX is an exclusive set of standards and technologies established by the world-renowned film production company, Lucasfilm Ltd. THX grew from George Lucas' personal desire to make your experience of the film soundtrack, in both movie theatres and in your home theatre, as faithful as possible to what the director intended.

Movie soundtracks are mixed in special movie theatres called dubbing stages and are designed to be played back in movie theatres with similar equipment and conditions. This same soundtrack is then transferred directly onto Laserdisc, VHS tape, DVD, etc., and is not changed for playback in a small home theatre environment.

THX engineers developed patented technologies to accurately translate the sound from the movie theatre environment into the home, correcting the tonal and spatial errors that occur. On this product, when the THX indicator is on, THX features are automatically added in Cinema modes (e.g. THX Cinema, THX Surround EX).

■ Re-Equalization

The tonal balance of a film soundtrack will be excessively bright and harsh when played back over audio equipment in the home because film soundtracks were designed to be played back in large movie theatres using very different professional equipment. Re-Equalization restores the correct tonal balance for watching a movie soundtrack in a small home environment.

■ Timbre Matching

The human ear changes our perception of a sound depending on the direction from which the sound is coming. In a movie theatre, there is an array of surround speakers so that the surround information is all around you. In a home theatre, you use only two speakers located to the side of your head. The Timbre Matching feature filters the information going to the surround speakers so that they more closely match the tonal characteristics of the sound coming from the front speakers. This ensures seamless panning between the front and surround speakers.

■ Adaptive Decorrelation

In a movie theatre, a large number of surround speakers help create an enveloping surround sound experience, but in a home theatre there are usually only two speakers. This can make the surround speakers sound like headphones that lack spaciousness and envelopment. The surround sounds will also collapse into the closest speaker as you move away from the middle seating position. Adaptive Decorrelation slightly changes one surround channel's time and phase relationship with respect to the other surround channel. This expands the listening position and creates – with only two speakers – the same spacious surround experience as in a movie theatre.

■ A.S.A. (Advanced Speaker Array)

ASA is a proprietary THX technology which processes the sound fed to 2 surround and 2 surround back speakers to provide the optimal surround sound experience. When you set up your home theater system using all eight speaker outputs (Left, Center, Right, Surround Right, Surround Back Right, Surround Back Left, Surround Left and Subwoofer), placing the two Surround Back speakers close together facing the front of the room as shown in the diagram will provide the largest sweet spot. If for practical reasons you have to place the Surround Back speakers apart, you will need to go to the THX Audio Set-up screen and choose the setting that most closely corresponds to the speaker distance, which will re-optimize the surround sound field. ASA is used in two new surround modes; THX Ultra2 Cinema and THX Music Mode.

■ THX ULTRA2 CINEMA MODE

THX Ultra2 Cinema mode plays 5.1 movies using all 8 speakers giving you the best possible movie watching experience. In this mode, ASA processing blends the side surround speakers and back surround speakers providing the optimal mix of ambient and directional surround sounds. This mode permits the playback of a non Surround EX/ES encoded 5.1 movie to be played back over a 7.1 system. DTS-ES (Matrix and 6.1 Discrete) and Dolby Digital Surround EX encoded soundtracks will be automatically detected, if the appropriate flag has been encoded. Some Dolby Digital Surround EX soundtracks are missing the digital flag that allows automatic switching. If you know that the movie that you are watching is encoded in Surround EX, you can manually select the THX Surround EX playback mode, otherwise THX Ultra2 Cinema mode will apply ASA processing to provide optimum replay.

■ THX MUSIC MODE

For the replay of multi-channel music the THX Music Mode should be selected. In this mode THX ASA processing is applied to the surround channels of all 5.1 encoded music sources such as DTS, and Dolby Digital to provide a wide stable rear soundstage. This mode is to be used with multi-channel music sources such as DTS 5.1 music and Dolby Digital 5.1 music.

■ B.G.C. (Boundary Gain Compensation)

If your chosen listening room layout (for practical or aesthetic reasons) results in most of the listeners being close to the rear wall, the resulting bass level can be sufficiently reinforced by the boundary that the overall sound quality becomes 'boomy'. THX Ultra2 receivers contain the BGC (Boundary Gain Compensation) feature to provide an improved bass balance. BGC can be selected by choosing 'On' from the 'BGC' section of the 'THX Set' setup menu.

■ THX Ultra2

Before any home theatre component can be THX Ultra2 certified, it must pass a rigorous series of quality and performance tests. Only then can a product feature the THX Ultra2 logo, which is your guarantee that the Home Theatre products you purchase will give you superb performance for many years to come. The THX Ultra2 specification provides uncompromised eight-channel playback of any multi-channel program, whether movie soundtracks or music over the widest possible seating area. In addition, all Ultra2 controllers and receivers incorporate video switching capable of handling all wide-bandwidth sources, including HDTV and progressive scan DVD, without degrading the picture.

■ THX Surround EX

THX Surround EX - Dolby Digital Surround EX is a joint development of Dolby Laboratories and the THX Ltd. In a movie theater, film soundtracks that have been encoded with Dolby Digital Surround EX technology are able to reproduce an extra channel which has been added during the mixing of the program. This channel, called Surround Back, places sounds behind the listener in addition to the currently available front left, front center, front right, surround right, surround left and subwoofer channels. This additional channel provides the opportunity for more detailed imaging behind the listener and brings more depth, spacious ambience and sound localization than ever before.

Movies that were created using the Dolby Digital Surround EX technology, when released into the home consumer market may exhibit wording to that effect on the packaging. A list of movies created using this technology can be found on the Dolby web site at www.dolby.com. A list of available DVD software titles encoded with this technology can be found at www.thx.com.

Only receiver and controller products bearing the THX Surround EX logo, when in the THX Surround EX mode, faithfully reproduce this new technology in the home. This product may also engage the THX Surround EX mode during the playback of 5.1 channel material that is not Dolby Digital Surround EX encoded. In such case the information delivered to the Surround Back channel is program dependent and may or may not be very pleasing depending on the particular soundtrack and the tastes of the individual listener.

■ ITU-R

ITU-R is the radio communication sector of the ITU (International Telecommunication Union). ITU-R recommends a standard speaker placement which is used in many critical listening rooms, especially for mastering purposes.

BLOCK DIAGRAMS

Block diagram

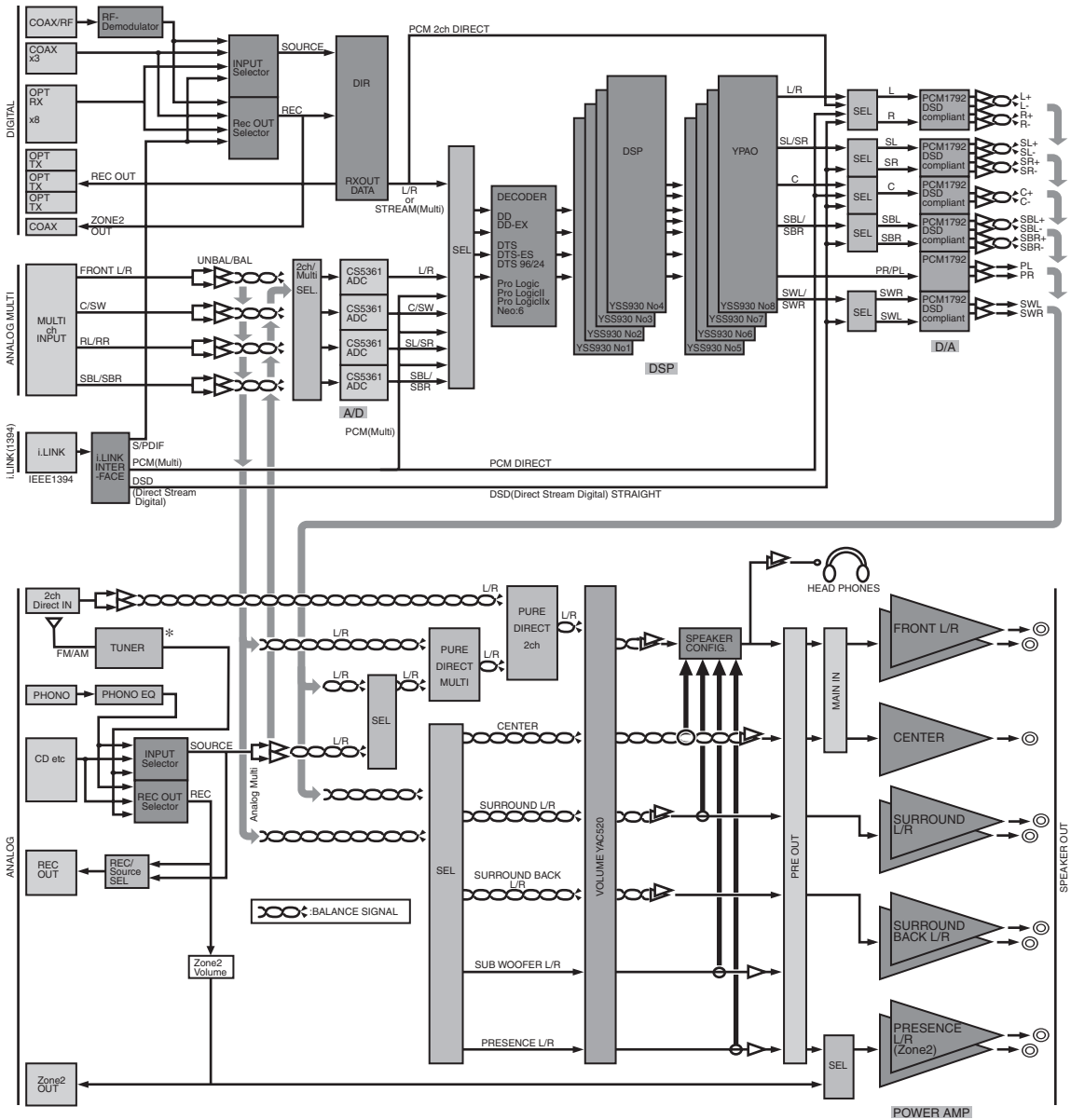

* Tuner section for U.S.A., Canada and Australia models only.

Video matrix

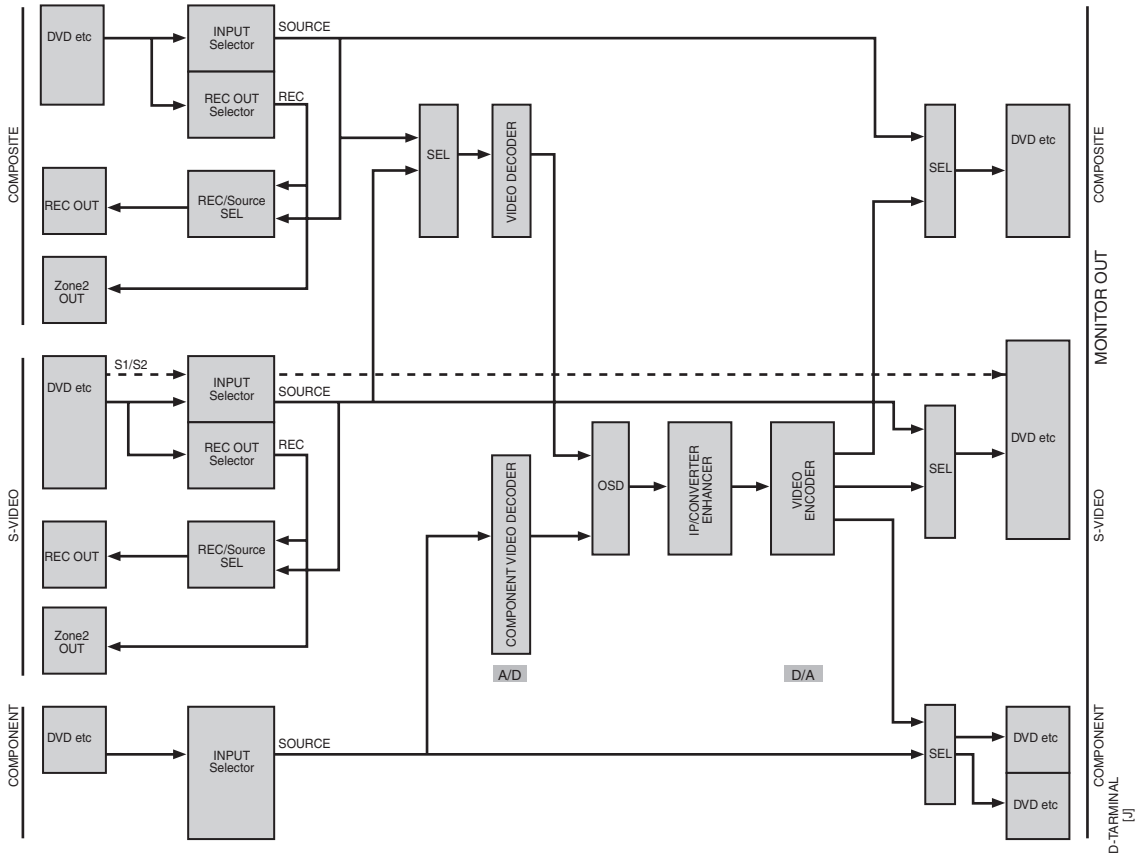

Power supply

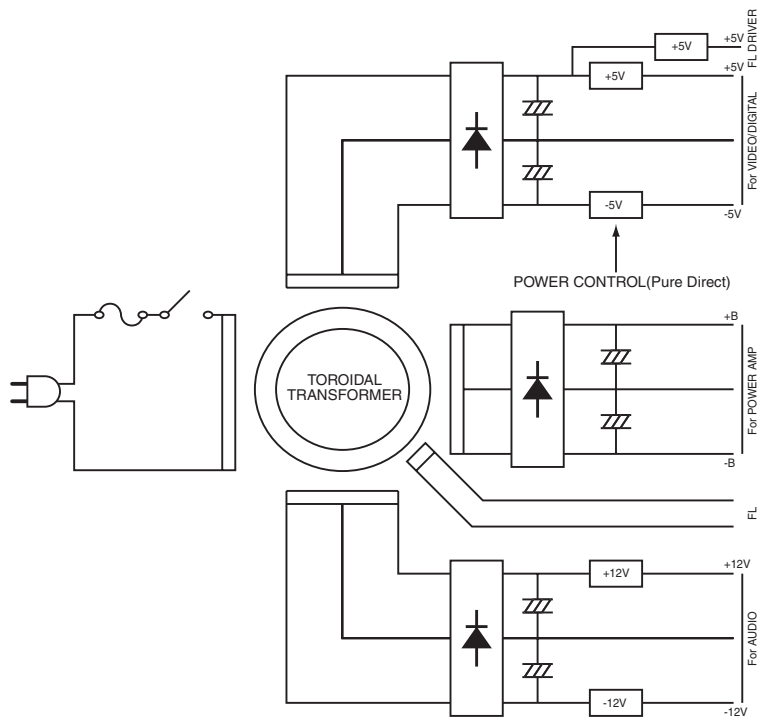

SPECIFICATIONS

AUDIO SECTION

- Minimum RMS Output Power
 - 20 Hz to 20 kHz, 0.015% THD, 8 Ω
 - Front, Center, Surround, Surround back 170 W
 - 1 kHz, 0.05% THD
 - Presence 50 W
- Maximum Power (EIAJ) [China, Korea and General models]
 - 1 kHz, 10% THD, 8 Ω
 - Front, Center, Surround 250 W
 - Surround back 200 W
 - Presence 70 W
- DIN Standard Output Power [Europe and U.K. models]
 - 1 kHz, 0.7% THD, 4 Ω
 - Front, Center, Surround, Surround back 300 W
 - Presence 90 W
- IEC Power [Europe and U.K. models]
 - 1 kHz, 0.015% THD, 8 Ω, Front 175 W
- Dynamic Power (IHF)
 - 8/6/4/2 Ω 210/260/340/580 W
- Damping Factor (IHF)
 - 20 Hz to 20 kHz, -8 Ω, Front L/R, Center 200 or more
- Frequency Response
 - CD to Front L/R 10 Hz to 100 kHz, -3 dB
- Total Harmonic Distortion
 - 20 Hz to 20 kHz, 85 W, 8 Ω, Front L/R 0.005%
- Signal to Noise Ratio (IHF-A Network)
 - Phono MM (5 mV) to Front L/R 86 dB
 - CD (200 mV, shorted) to Front L/R, Effect Off 97 dB
- Residual Noise (IHF-A Network)
 - Front L/R 150 μV or less
- Channel Separation (1 kHz/10 kHz)
 - CD (5.1 kΩ terminated) to Front L/R 70 dB/60 dB
- Tone Control (Front, Center)
 - BASS Boost/Cut 50 Hz +6 dB/-6 dB
 - TREBLE Boost/Cut 20 kHz +6 dB/-6 dB
- Phones Output 200 mV/100 Ω
- Input Sensitivity
 - PHONO 2.5 mV/47 kΩ
 - CD, etc, MULTI CH 200 mV/47 kΩ
 - Front, Center 1 V/47 kΩ
- Output Level
 - REC OUT 200 mV/0.5 kΩ
 - PRE OUT 1.0 V/0.5 kΩ
 - SUBWOOFER, Split 2.0 V/0.5 kΩ
 - SUBWOOFER, Mono 4.0 V/0.5 kΩ

VIDEO SECTION

- TV Format
 - [U.S.A., Canada and Korea models] NTSC/PAL
 - [Other models] PAL/NTSC
- Video Conversion 480i/576i
- Composite Video Signal Level 1 Vp-p/75 Ω
- S-Video Signal Level Y:1 Vp-p 75 Ω, C:0.286 Vp-p/75 Ω
- Component Video Signal Level
 - Y 1 Vp-p/75 Ω
 - Pb/Cb, Pr/Cr 0.7 Vp-p/75 Ω
- Video Maximum Input Level 1.5 Vp-p or more
- Signal to Noise Ratio (Processor Off) 70 dB or more
- Frequency Response (MONITOR OUT)
 - Composite, S-Video 5 Hz to 10 MHz, -3 dB
 - Component 5 Hz to 100 MHz, -3 dB

GENERAL

- Power Supply
 - [U.S.A. and Canada models] AC 120 V/60 Hz
 - [Australia model] AC 240 V/50 Hz
 - [Europe and U.K. models] AC 230 V/50 Hz
 - [China model] AC 220 V/50 Hz
 - [Korea model] AC 220 V/60 Hz
 - [General model] AC 110/120/220/230 to 240 V, 50/60 Hz
- Power Consumption
 - [U.S.A. and Canada models] 1000 W/1220 VA
 - [Other models] 1000 W
- Standby Power Consumption 1.0 W or less
- AC Outlets
 - [U.S.A. and Canada models] 1 (Switched, 120 W/1.0 A maximum)
 - [Australia and U.K. models] 1 (Switched, 120 W maximum)
 - [Europe, China and General models] 2 (Switched, Total 120 W maximum)
- Dimension (W x H x D) 435 x 211 x 471 mm
(17-1/8" x 8-5/16" x 18-1/2")
- Weight 30.0 kg (66 lbs)



This document is printed on chlorine free (ECF) paper with soy ink.

© 2003 YAMAHA CORPORATION All rights reserved.

YAMAHA ELECTRONICS CORPORATION, USA 6660 ORANGETHORPE AVE., BUENA PARK, CALIF. 90620, U.S.A.
YAMAHA CANADA MUSIC LTD. 135 MILNER AVE., SCARBOROUGH, ONTARIO M1S 3R1, CANADA
YAMAHA ELECTRONIK EUROPA G.m.b.H. SIEMENSSTR. 22-34, 25462 RELINGEN BEI HAMBURG, F.R. OF GERMANY
YAMAHA ELECTRONIQUE FRANCE S.A. RUE AMBROISE CROIZAT BP70 CROISSY-BEAUBOURG 77312 MARNE-LA-VALLEE CEDEX02, FRANCE
YAMAHA ELECTRONICS (UK) LTD. YAMAHA HOUSE, 200 RICKMANSWORTH ROAD WATFORD, HERTS WD18 7GQ, ENGLAND
YAMAHA SCANDINAVIA A.B. J A WETTERGRENS GATA 1, BOX 30053, 400 43 VÄSTRA FRÖLUNDA, SWEDEN
YAMAHA MUSIC AUSTRALIA PTY, LTD. 17-33 MARKET ST., SOUTH MELBOURNE, 3205 VIC., AUSTRALIA

YAMAHA CORPORATION

Printed in Japan  WB74160