

# YAMAHA CX-1000

*Natural Sound Stereo Control Amplifier*

*Préamplificateur stéréo de la série "Natural Sound"*

*"Natural Sound"-Stereoregler*

*Stereokontrollförstärkare med naturligt ljud*

*Amplificatore di controllo stereo a suono naturale*

CENTER

**English**..... 1

- *Connection Diagram*..... 3
- *Digital Connections* ..... 4
- *Tone Control Characteristics* ..... 85
- *Front Panel Illustration*..... 86
- *Block Diagram* ..... 87

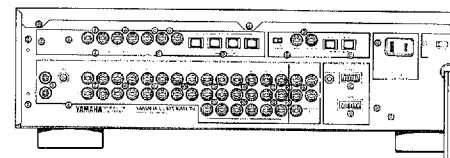

General mo  
Modèle univer  
Allgemeines möc  
Modellen för övriga länc  
Modello gener.

**Français**..... 18

- *Schéma des Connexions* ..... 3
- *Connexions Numeriques* ..... 4
- *Caracteristiques de Controle de Tonalite* ..... 85
- *Illustration du Panneau Avant*..... 86
- *Schéma de Principe* ..... 87

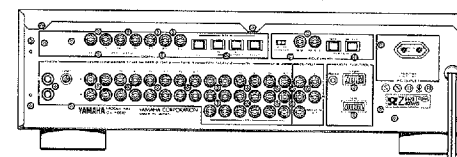

European moc  
Modèle pour l'Euro  
Modell für Euro  
Modellen för Euro  
Modello Europ

**Deutsch**..... 34

- *Anschlußschema* ..... 3
- *Digital-Arschlüsse* ..... 4
- *Regelbereich der Klangregler* ..... 85
- *Abbildung der Vorderseite*..... 86
- *Blockschaltbild* ..... 87

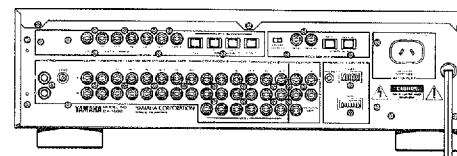

Australian moc  
Modèle pour l'Austra  
Modell für Australi  
Modellen för Australi  
Modello Australia

**Svenska**..... 53

- *Kopplingsdiagrammet*..... 3
- *Hmn Bxzi de Digitala Anslutningarna* ..... 4
- *Klangfärfskara Kteristik* ..... 85
- *Illustrationen på Framsidan* ..... 86
- *Blockschaltbild* ..... 87

**Italiano**..... 70

- *Schema di Collegamento* ..... 3
- *Connessioni Digitali* ..... 4
- *Caratteristiche di Controllo Toni* ..... 85
- *Illustrazione del Pannello Anteriore*..... 86
- *Diagramma di Flusso* ..... 87

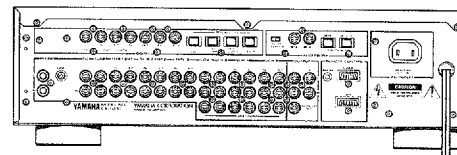

U.K. mod  
Modèl pour la Grande-Bretagr  
Modell für Großbritanin  
Modellen för Storbritannin  
Modello britannic

---

Thank you for purchasing the YAMAHA CX-1000 control amplifier.

## **ABOUT THIS MANUAL**

To obtain the finest performance from your new control amplifier, please read this manual carefully, keeping it handy for future reference. After you know which PRECAUTIONS to take, the section CONNECTIONS will show you how to hook up the CX-1000 to your power amplifier and other stereo components. FRONT PANEL CONTROLS AND THEIR FUNCTIONS introduces the CX-1000's switches and knobs, while operation of this control amplifier is explained in more detail in the OPERATIONS and REMOTE CONTROL section. If you have any trouble, the final section on TROUBLESHOOTING tells you what to do before contacting your YAMAHA dealer.

## **HI-BIT TECHNOLOGY**

The CX-1000 is capable of accepting both analog and digital signals from components. Digital connections may be made by using either coaxial connectors or optical fiber connectors. Automatic detection of the data rate is performed, using the Hi-Bit technology system, with an 18-bit filtering system and 8 times oversampling, dramatically reducing the possibility of digital "dropout". Any sampling noise is boosted by the three-stage filtering process to frequencies so far above the music that there is virtually no chance of its interfering with your listening pleasure. Excellent linearity is achieved by use of the Hi-Bit twin D/A convertors, using a floating system to shift low-level signals away from the area of most likely convertor error. Direct output from the D/A convertors results in a pure sound amazingly close to the original.

## **CONTENTS**

SAFETY INSTRUCTIONS .....	2
CONNECTION DIAGRAM .....	3
DIGITAL CONNECTIONS .....	4
SUPPLIED ACCESSORIES .....	5
CONNECTIONS .....	6
FRONT PANEL CONTROLS AND THEIR FUNCTIONS .....	8
OPERATIONS .....	11
REMOTE CONTROL .....	13
TROUBLESHOOTING .....	16
SPECIFICATIONS .....	17

### **IMPORTANT:**

Please record the serial number of your unit in the space below.

Model: CX-1000

Serial No.:

# SAFETY INSTRUCTIONS

## OWNER'S MANUAL

Keep this manual in a safe place for future reference.

## LOCATION

Avoid placing your CX-1000 in direct sunlight or close to a source of heat. Also avoid locations in which the device is likely to be subjected to excessive dust, cold or moisture.

## VENTILATION

The openings on the cabinet ensure the ventilation of the amplifier. If these openings are obstructed, the temperature inside the cabinet will rise rapidly and eventually damage the circuits. Therefore, avoid placing objects against these openings and do not install your amplifier in a place such that the flow of air through the ventilation openings could be impeded.

## HANDLING

### ■ Power cord

When removing the power plug from the wall outlet, always pull directly on the plug. Never yank the cord as this may result in damage to the cord and possibly a short-circuit.

If you do not intend to use this unit for an extended period of time, it is advisable to unplug the power cord.

### ■ Switches and knobs

Avoid applying excessive force to the switches and knobs.

### ■ Relocation

Before moving your amplifier, be sure to unplug the power cord and remove all other connecting cables.

## IN CASE OF TROUBLE

### ■ Troubleshooting Chart

Consult the Troubleshooting Chart for advice on the common operation errors before concluding that your amplifier is faulty.

### ■ Servicing

Do not open the cabinet or attempt to make repairs by yourself, as this may aggravate the damage and expose you to an electrical shock.

### ■ Object and liquid entry

See to it that foreign objects or spilled liquids do not enter inside the cabinet. Should this case arise, consult your YAMAHA dealer.

## CLEANING

Wipe off dust with a dry soft cloth. To remove dirt or fingermarks, use a soft damp cloth then dry immediately with a clean cloth. Do not use alcohol, thinners or other chemical solvents since they may damage the finish or remove the panel lettering.

Do not use any aerosol sprays near this unit as these products can easily get into the unit and damage the circuitry.

### ■ VOLTAGE SELECTOR

#### (General Model only)

The voltage selector switch on the CX-1000 rear panel must be set for your local voltage BEFORE plugging in the AC mains supply. Voltages are 110/120V, 220/240V AC, 50/60Hz.

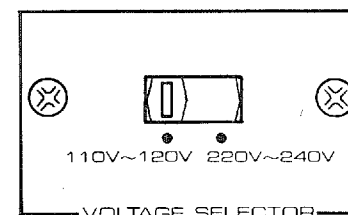

### Special instructions for the U.K.

THE WIRES IN THE MAINS LEAD ARE COLOURED IN ACCORDANCE WITH THE FOLLOWING CODE:

Blue: NEUTRAL

Brown: LIVE

As the colours of the wires in the mains lead of this apparatus may not correspond with the coloured markings identifying the terminals in your plug, proceed as follows: The wire which is coloured BLUE must be connected to the terminal which is marked with the letter N or coloured BLACK. The wire which is coloured BROWN must be connected to the terminal which is marked with the letter L or coloured RED.

CONNECTION DIAGRAM

ANSCHLUSSDIAGRAMM

SCHEMA DI COLLEGAMENTO

SCHEMA DES CONNEXIONS

KOPPLINGSDIAGRAMMET

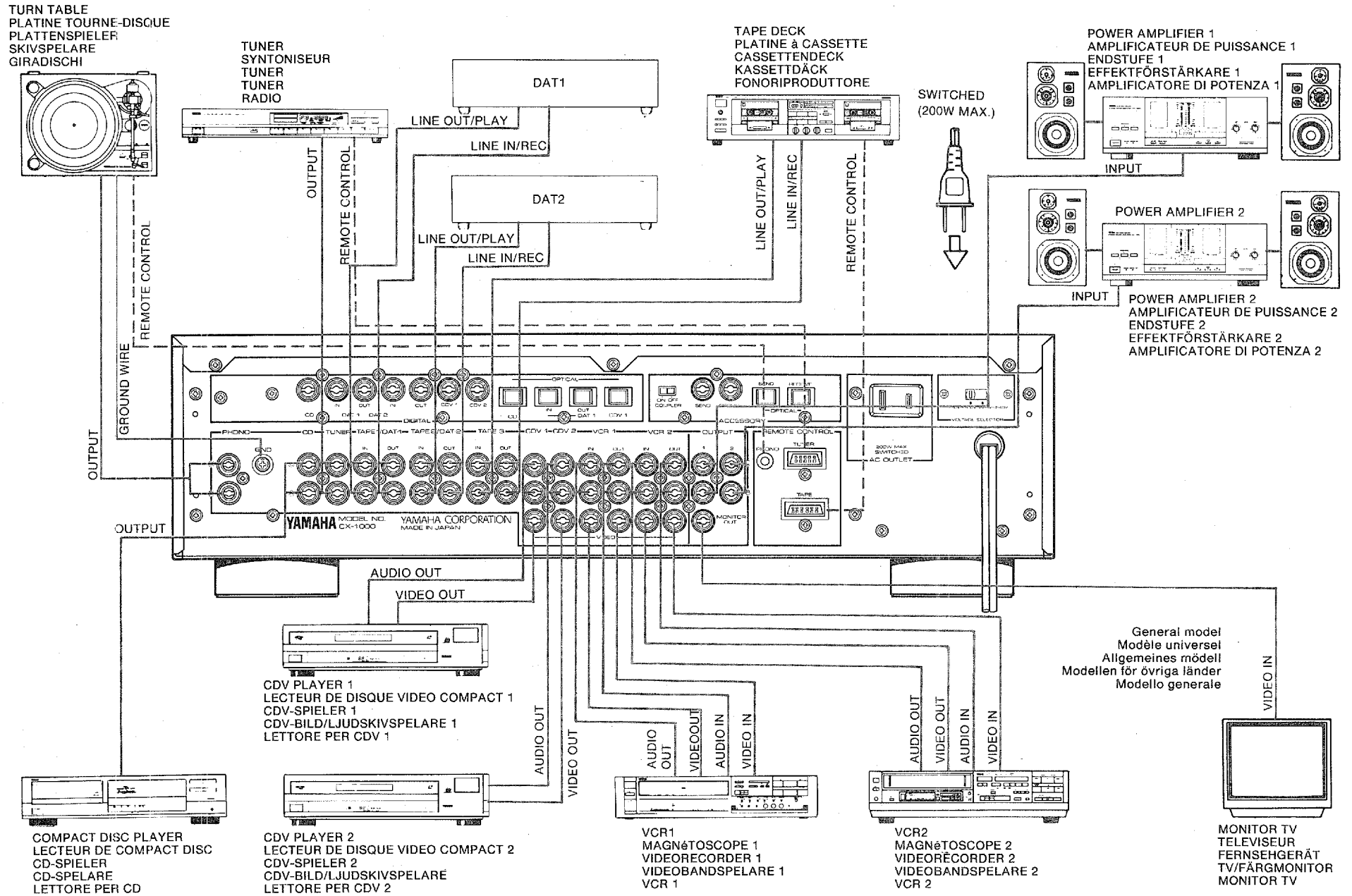

# DIGITAL CONNECTIONS

# CONNEXIONS NUMERIQUES

# DIGITAL-ANSCHLÜSSE

# HMNBXZI DE DIGITALA ANSLUTNINGARNA

# CONNESSIONI DIGITA

### NOTES:

1. Note that optical and coaxial digital cables transmit both channels (L and R) through a single line.
2. Before using the OPTICAL connectors, remove the connector covers by pulling them toward you. If the OPTICAL connectors are not used, be sure to replace the connector covers to protect them from dirt or dust.

### REMARQUES:

1. Noter que les cordons numériques coaxiaux et les cordons optiques transmettent les deux canaux (gauche et droit) par une seule ligne.
2. Avant d'utiliser les connecteurs OPTICAL, enlever les caches en les tirant vers soi. Lorsque ces connecteurs OPTICAL ne sont pas utilisés, veiller à replacer les caches, afin d'empêcher tout encrassement.

### HINWEISE:

1. Die Lichtfaser- und Koaxkabel übertragen beide Kanäle (L und R) auf ein und derselben Leitung.
2. Entfernen Sie vor der Verwendung der Buchsen OPTICAL die Kapfen, indem Sie sie zu sich hinziehen. Werden die Buchsen OPTICAL nicht gebraucht, müssen die Kapfen wieder angebracht werden, um zu verhindern, daß Schmutz oder Staub in das Innere gelangt.

### OBS!

1. Observera att såväl de optiska som de koaxiala, digitala kablarna överför ljudsignalerna via de vänstra (L) och de högra (R) kanalerna genom att utnyttja en enda kabel.
2. Dra ut skydden ur de optiska ljudingångarna OPTICAL genom att dra skydden mot dig själv. Var noga med att skjuta in skydden i de optiska OPTICAL ljudingångarna, när inga anslutningar utförs till dessa ljudingångar, för att skydda ingångarna mot smuts och damm.

### NOTA:

1. Notare che i cavi digitali coassiali ed ottici trasmettono tutti e due i canali (L e R) mediante una sola linea.
2. Prima di usare i connettori ottici, togliere i coperchi dei medesimi tirandoli verso Lei. Se non si usano i connettori, rimettere i coperchi per proteggere i connettori dalla sporcizia e polvere.

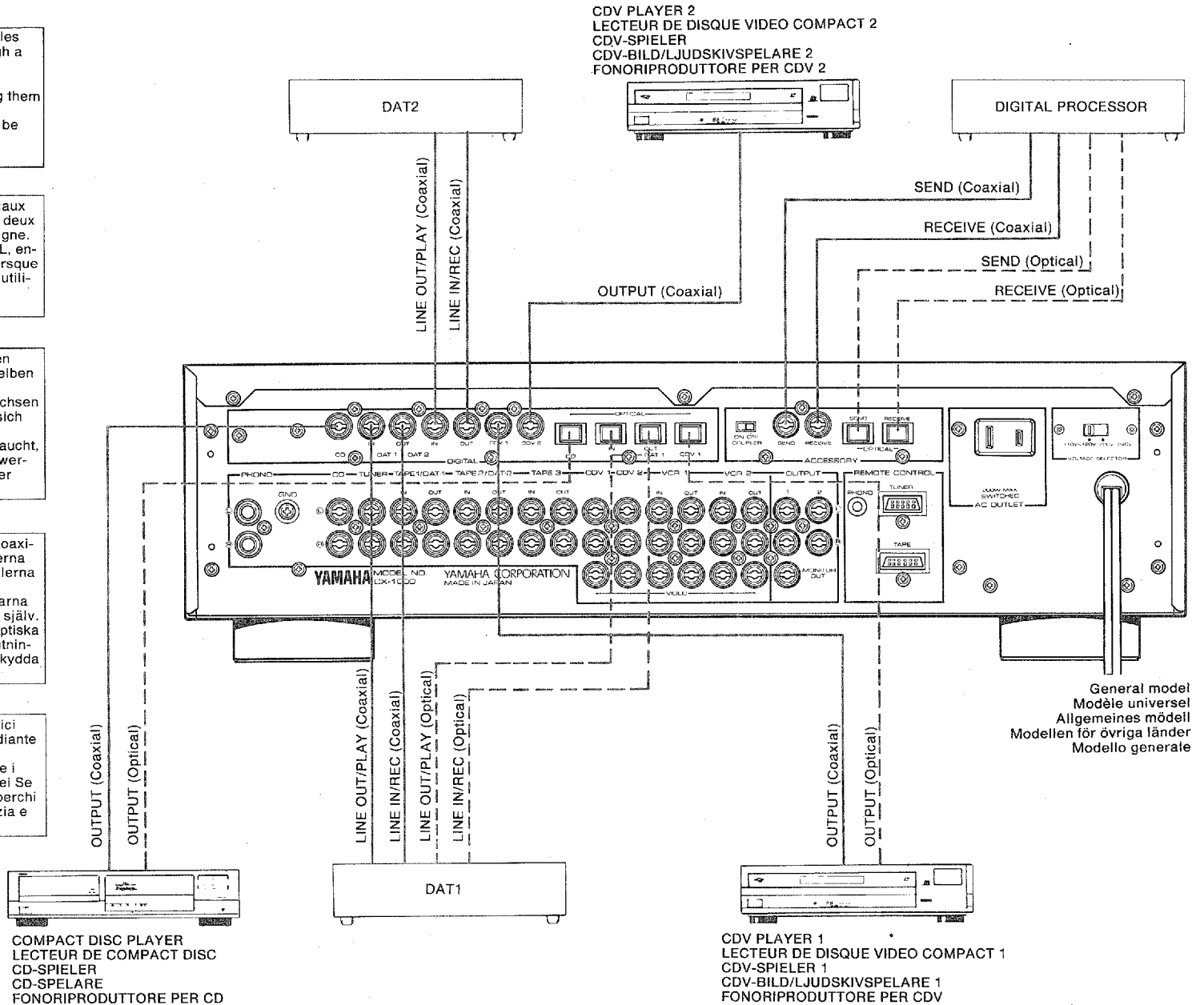

# SUPPLIED ACCESSORIES

After unpacking, check that the following parts are contained.

● Remote control transmitter (RS-CX1000)

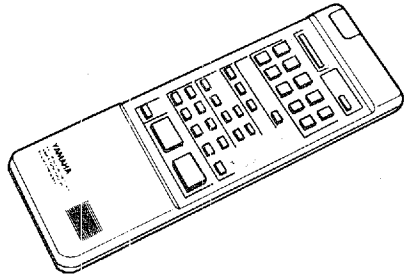

● Remote control cable (mini-plug, turntable)

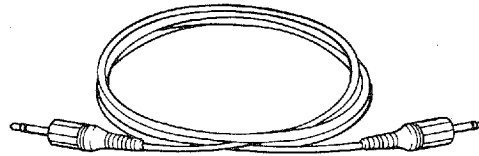

● Remote control cable (5-pin, tuner)

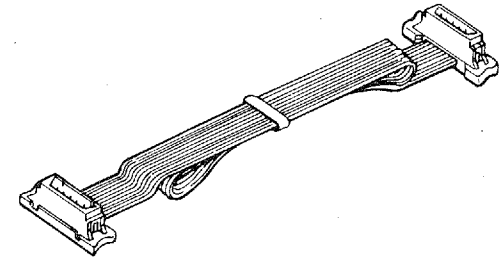

● Batteries (size "AA")

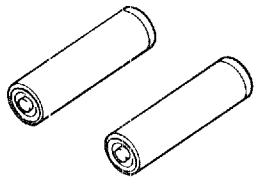

● Connecting cable (RCA plug)

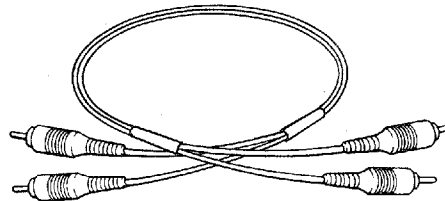

● Remote control cable (6-pin, cassette deck)

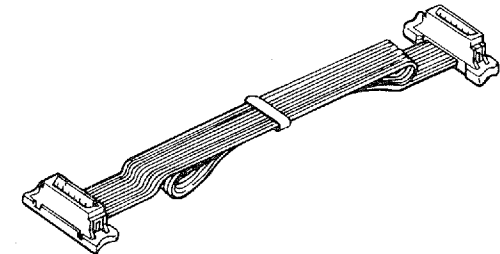

● Protective caps for the optical terminals x 6

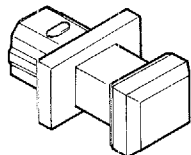

● Shorting pins for the PHONO terminals x 2

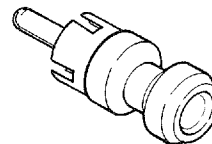

★These are used to short the PHONO terminals when no turntable is connected, thus avoiding hum.

★Do not use those shorting pins to short any output terminals.

# CONNECTIONS

---

To help you distinguish between types of terminals at a glance, analog audio jacks are black, digital (coaxial) audio jacks are green, and video jacks are yellow.

The diagram on page 3 shows only the analog connections which may be made to the CX-1000. Digital connections are shown in the diagram below on page 4.

Make sure the left (L) and right (R) channels are connected consistently between components.

## NOTE:

Before making or altering any of the connections described below, be sure to turn off all components.

Always check that

- a) the RCA plug pins of any connecting cords are clean,
- b) the digital pins of the optical fiber cords are clean too,
- c) the left and right channels of all units are connected consistently, and
- d) connections are made securely.

## POWER AMPLIFIER

Connect the OUTPUT1 (or OUTPUT2) jacks of the CX-1000 to the INPUT jacks of your power amplifier.

## AUDIO SIGNALS

### ■ TURNTABLE

Plug the turntable's output cords into the PHONO jacks. Partly unscrew the CX-1000 GND screw terminal and connect the turntable's ground wire, then tighten the screw. Grounding the turntable in this

manner usually produces the least hum. However, the ground wire may be left disconnected if this gives better results.

### ■ CD PLAYER

Connect the output cords of your compact disc player to the CD jacks

### ■ TUNER

Plug the cords from your tuner's output jacks into the the TUNER jacks

### ■ DAT DECK

Connect the LINE OUT (or equivalent) jacks of your Digital Audio Tap deck to the TAPE1/DAT1 (or TAPE2/DAT2) IN jacks, and the deck's LINE IN jacks to the TAPE1/DAT1 (or TAPE2/DAT2) OUT jacks.

### ■ TAPE DECK

Connect the LINE OUT jacks of the tape deck to the TAPE3 IN jacks and the deck's LINE IN jacks to the TAPE3 OUT jacks.

### ■ CDV PLAYER (or VDP)

Connect the L and R audio signal outputs of a CDV or VDP (video disc player) to the CDV1 (or CDV2) jack.

### ■ VCR1/VCR2

Connections are basically the same as described above for a DAT or analog tape deck - the stereo audio outputs of a video cassette recorder are routed to the VCR1 (or VCR2) IN terminals, while the VCR's audio inputs are connected to the OUT terminals.

## VIDEO SIGNALS

### ■ CDV PLAYER (or VDP)

Connect the video signal output of a CDV or VDP (video disc player) to the VIDEO CDV1 (or CDV2) jack.



## ■ VCR1/VCR2

Connect the video output of a VCR to the VCR1 IN jack. Use the VCR1 OUT jack for connection of the VCR's video input terminal. A second VCR can be connected in exactly the same manner using the VCR2 IN and OUT jacks.

## ■ TV SET (or MONITOR)

Connect the MONITOR OUT jack to the video input terminal of your television set or monitor.

## REMOTE CONTROL

The remote control cables from Yamaha turntable, tuner and cassette deck models (featuring the RS mark shown below) can be connected to the REMOTE CONTROL PHONO, TUNER and TAPE terminals. These components can then be operated along with a compatible CD player and the CX-1000 itself via the remote control transmitter RS-CX1000.



The **RS** symbol indicates Yamaha **RS** integrated system remote control compatible components.

## AC OUTLETS

For your convenience, the CX-1000 is equipped with an AC outlet on the rear panel for connection of an other component. Power to the SWITCHED outlet is turned on and off by the CX-1000 power switch.

### NOTE:

Never connect a component with a power consumption of more than 200W to this outlet.

## DIGITAL AUDIO SIGNALS

Digital optical connections can be made for a CD player, a DAT recorder and a CDV player. Coaxial terminals are provided for a CD player, two DAT recorders and two CDV players.

If you have connected these units to the analog jacks as well, the digital connections will have priority. However, to ensure optimum sound quality, we recommend disconnecting the corresponding analog jacks when using the digital terminals.

When optical and coaxial terminals are used simultaneously, the optical connections have priority.

### ■ CD PLAYER

Connect the digital output cord of your compact disc player to the CD jack.

### ■ DAT DECK

Connect the DIGITAL LINE OUT jack of your Digital Audio Tape deck to the DAT1 (or DAT2 for coaxial only) IN jack, and the deck's DIGITAL LINE IN jack to the DAT1 (or DAT2 for coaxial only) OUT jack.

### ■ CDV PLAYER (or VDP)

Connect the digital output cord of the CDV or VDP (video disc player) to the CDV1 (or CDV2 for coaxial only) jack.

### ■ ACCESSORY JACKS

Use these jacks to connect a digital graphic equalizer, sound processor, etc. If digital equipment is connected via the accessory jacks, set the COUPLER switch to OFF.

Otherwise keep the COUPLER switch in the ON position.

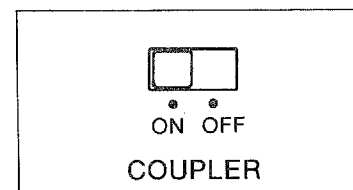

# **FRONT PANEL CONTROLS AND THEIR FUNCTIONS**

(Front Panel Illustration ..... page 86)

## **① POWER switch and indicator**

Pressing this switch turns power on, causing the POWER indicator to light. To turn the unit off, press again.

(For U.K. and Europe model only)

When the power cord is inserted into the mains socket, the POWER indicator will illuminate at half intensity. This indicates a "stand-by" mode, which allows the amplifier to be switched on either by pressing the POWER switch, or by means of the ON key on the remote control unit. Pressing the POWER switch again (or the OFF key on the remote control unit) will return the amplifier to "stand-by" mode. The power cord must be removed from the mains supply in order to disconnect power completely from the CX-1000.

## **② PHONES jack**

Plugging in headphones here mutes the output to the power amplifier, allowing private listening.

## **③ Tone controls**

These three controls allow you to adjust the tonal quality of the sound according to source and speaker characteristics, room acoustics and personal preferences.

A flat response (i.e. no equalization effect) is obtained in the center DEFEAT position. The turnover frequencies for the three controls are:

BASS: 350Hz MID: 1kHz TREBLE: 3.5kHz

## **④ BALANCE control**

Adjusts the relative volume of the left and right channels. Use this knob to compensate for stereo imbalance due to the location of the speakers, room acoustics or the source program.

## **⑤ SAMPLING FREQUENCY indicators**

When the input source is a digital source (CD, DAT or CDV), and a digital connection (either coaxial or optical) has been made to the CX-1000, one of these indicators will illuminate to show the rate at which the CX-1000 samples the digital data being fed into it.

The different sampling frequencies used are:

32kHz DAT 44.1kHz CD 48kHz DAT

## **⑥ SUBSONIC FILTER switch**

Activates circuitry which eliminates ultra-low frequency signals caused by turntable rumble or warped records. Such interference drains amplifier power and may even harm speakers if not attenuated with this switch.

## **⑦ MODE switch**

Switches between stereo and mono modes.

## **⑧ VIDEO switch**

This turns the video signals of video sources (VCR or CDV) on and off. When this switch is in the ON position, you can watch the pictures of the selected video source on your monitor screen.

## 9 INPUT SELECTOR

To select a source for listening or watching, press either end (< or >) of the INPUT SELECTOR until the desired source is indicated on the input indicator 11.

Input sources can be selected directly with the supplied remote control unit (see below).

## 10 LOUDNESS control

This continuously variable loudness control allows you to compensate for the human ear's loss of sensitivity to low and high frequencies at low volumes. It lets you progressively attenuate the middle range in order to retain a natural balance with the bass and treble when listening at low levels. Normally, this control should be set to the FLAT position. See below for operation details.

## 11 Input indicators

These indicate the source selected with the INPUT SELECTOR 9. Normally, these indicators are red. However, when the VIDEO switch 8 is on and the audio source selected is different from the video source, the respective video source indicator will turn green.

### NOTE:

When VIDEO switch on, one of the green video source (VCR or CDV) indicators always remains lit, even if you select an audio source. This means you can listen to the sound of the selected audio equipment while simultaneously watching the picture of the indicated video source.

## 12 REC OUT selector

Determines which source will be recorded by the connected tape deck(s), DAT recorder(s) or VCR(s). In the SOURCE position, the source currently selected with the INPUT SELECTOR 9 is recorded. Use the SOURCE position when you want to make an analog recording of a digital signal.

When not recording, leave this rotary switch in the OFF position.

Any signals selected with REC OUT (except in the SOURCE position) are fed directly to the rear panel TAPE OUT, TAPE/DAT OUT and/or VCR OUT jacks, regardless of the current INPUT SELECTOR setting. This means you can listen to or watch any source while recording another.

For details on recording and dubbing, see OPERATIONS.

## 13 SOURCE DIRECT switch and indicators

Pressing this switch routes the audio input signal directly to the CX-1000 output stage, bypassing the tone controls, subsonic filter and the mode, loudness control circuits thus giving the purest possible sound. Its indicator will light.

Remember that none of the controls just mentioned will have any effect when SOURCE DIRECT is pressed, except MUTING.

### NOTE:

If the LOUDNESS control is currently being used, pressing SOURCE DIRECT will have the effect of suddenly raising the volume.

**14 PHONO type/impedance selector**

Set this switch to the position corresponding to the type of cartridge currently used by your turntable — MM (moving magnet — 1 kohm, 47 kohms/330 pF or 47 kohms/220 pF) or MC (moving coil — 1 kohm, 100 ohms or 10 ohms).

**15 MUTING switch and indicator**

Press to lower the volume by 20 dB without altering the VOLUME setting. Its indicator will light. To restore normal volume, press again.

**16 REMOTE CONTROL sensor**

Receives signals from the remote control transmitter. Make sure this window is not obstructed when using remote control.

**17 VOLUME control**

This knob adjusts the overall sound level. Turn clockwise to raise volume.

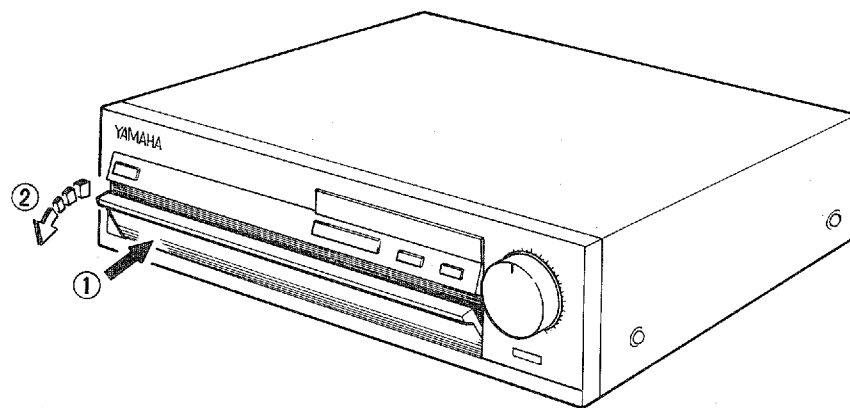

**■ HINGED FRONT PANEL**

Certain controls are normally covered by a hinged front panel. This protects them against damage due to dust, etc, and also prevents accidental resetting.

The panel may be opened in the following way:

- ① Press the bottom of the panel. The top will pivot outwards.
- ② The top of the hinged panel may then be pulled forward and down. The panel will swing under the controls, and the names of the controls are displayed on what is now the top surface of the panel.

To close the panel:

Push the front of the panel upwards. The panel will pivot upwards and inwards to hide the controls.

# OPERATIONS

## LISTENING AND WATCHING

For audio-only sources, or where the video source is the same as the audio source:

1. The component(s) you wish to listen to or watch should be turned on before powering up the CX-1000.
2. Making sure that the volume control is set to minimum level, press the CX-1000 POWER switch, then turn on your power amplifier.
3. Select the desired program source with the INPUT SELECTOR or remote control unit and activate the selected component.
4. Adjust the VOLUME, LOUDNESS, BALANCE and tone controls as desired.

To watch a video source while listening to a different audio source:

1. Follow steps 1 and 2 above.
2. Push in the VIDEO switch to the ON position.
3. Select the desired video source with the remote control INPUT SELECTOR keys (see p. 14). Its input indicator will light up red.
4. Next, select the audio source you want to listen to via the remote control, lighting its red indicator. The indicator of the video source selected in step 2, will turn green.

You can now watch the video source while listening to the selected audio source.

### NOTE:

It is not possible to watch a video source (such as VCR1) while listening to the audio signal of a different video source (such as CDV1).

## LOUDNESS ADJUSTMENT

When listening at low volume levels, adjust LOUDNESS (if required) by first setting this knob to the FLAT position and the VOLUME control to the maximum desired listening level. Then turn the LOUDNESS knob counterclockwise to reduce overall volume while retaining a natural sound.

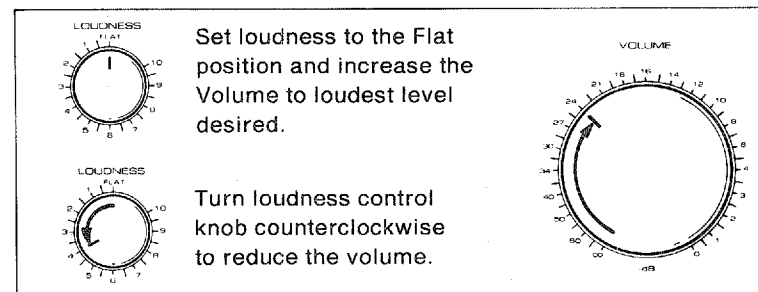

## AUDIO RECORDING

Audio sources or the sound-track of video sources can be recorded either with a connected DAT/cassette deck or a VCR. Since the source signal selected with the REC OUT selector is always present at the rear panel TAPE1/DAT1 (or TAPE2/DAT2, TAPE3, DIGITAL DAT1, DAT2) OUT jacks, audio recording is possible simultaneously with all connected decks (cassette recorder(s), DAT deck(s), VCR(s) etc.). To record from VCR/TAPE to DAT or vice versa, see "Dubbing" below.

When selected with the REC OUT rotary switch, the signals of digitally connected equipment are sent to the digital OUT terminals of the connected DAT deck(s). However, when this switch is set to SOURCE and the unit to be recorded is selected with the INPUT SELECTOR, the signals of the respective source are sent to the analog OUT terminals, even if the source is digitally connected.

**NOTE:**

It is not possible to record sources connected only via analog jacks with DATs that are connected only to digital terminal.

1. Select the source from you wish to record with REC OUT selector.
2. To confirm the source, press the corresponding INPUT SELECTOR.
3. Activate the program source, adjust the recording level on your deck(s), then start recording. (If your tape deck has three head monitoring capability, you can listen to the sound just recorded by choosing that deck with the INPUT SELECTOR.)
4. While recording, you can listen to or watch any other component without influencing the quality of the recording simply by selecting that component with the INPUT SELECTOR.

**NOTE:**

When recording with the REC OUT selector in the SOURCE position, it is not possible to watch or listen to any input source other than the recording source.

## AUDIO DUBBING

Dubbing, i.e. the copying of tapes or parts of tapes from one deck to another, is performed in basically the same manner as normal source recording. The REC OUT selector determines from which of two connected decks the recording will be made.

1. Select the source tape deck with REC OUT.
2. To monitor the sound during recording, also select the corresponding deck with the INPUT SELECTOR.
3. Start playback of the tape to be copied, adjust the recording level on the other deck, then start recording. (Again, if the recording tape deck has three head monitoring capability, you can listen to the sound just recorded by pressing the INPUT SELECTOR to choose that deck.)
4. During dubbing, you can listen to any other component without influencing the quality of the recording by selecting that component with the INPUT SELECTOR.

## VIDEO RECORDING

Any video source connected to the analog CDV1 (or CDV2) jacks can be recorded with the VCRs, regardless of the INPUT SELECTOR setting.

1. Set the REC OUT selector to CDV1 (or CDV2).
2. Set the VIDEO switch to ON.
3. Set the INPUT SELECTOR to CDV1 (or CDV2).
4. Set the VCR to the record mode, then start playback of the video source.

## REMOTE CONTROL

5. While recording, you can listen to or watch any other component without influencing the quality of the recording simply by selecting that component with the INPUT SELECTOR.

### NOTE:

If a video source which is only connected digitally is to be recorded on a VCR (analog connect only), the REC OUT selector must be set to SOURCE, and the INPUT SELECTOR must be set to the appropriate video input. While such a recording is taking place, no other components may be watched or listened to.

### VIDEO DUBBING

This is essentially the same as audio dubbing except that the VIDEO switch must be on. The REC OUT selector determines from which of the two connected VCRs the recording will be made.

The supplied remote control transmitter RS-CX1000 can be used to operate the CX-1000 itself as well as Yamaha remotely-controlled components featuring the RS mark (turntable, tuner, cassette deck and compact disc player) from the comfort of your chair.

See the section CONNECTIONS for information on how to connect these components to the CX-1000 for remote control. Note that no cable is necessary for remote control of a compatible CD player. See the operation manuals of the respective components for full details of their operation.

### BATTERY INSTALLATION

Install two AA batteries into the transmitter as shown below, taking care that the battery polarity corresponds to the illustration on the battery compartment floor. Remove them when not using the transmitter for an extended period of time.

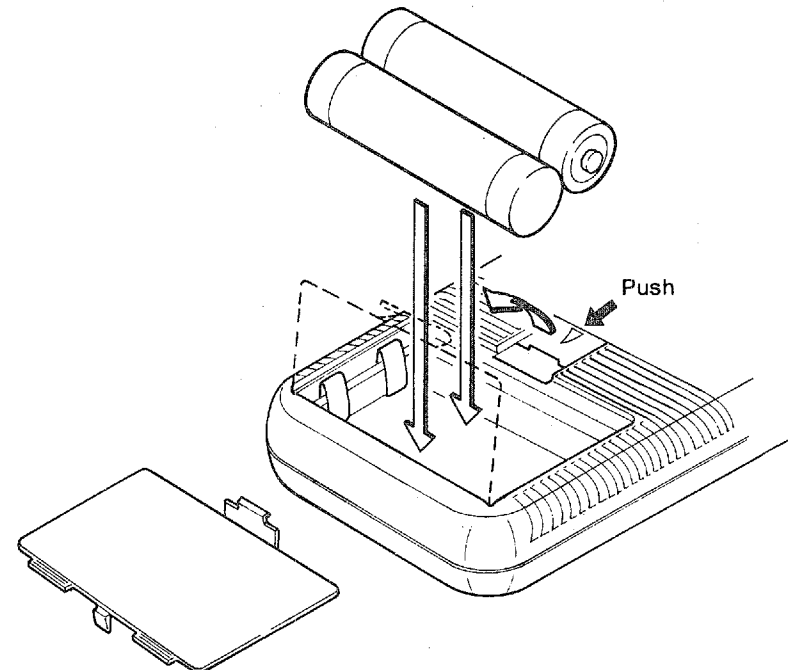

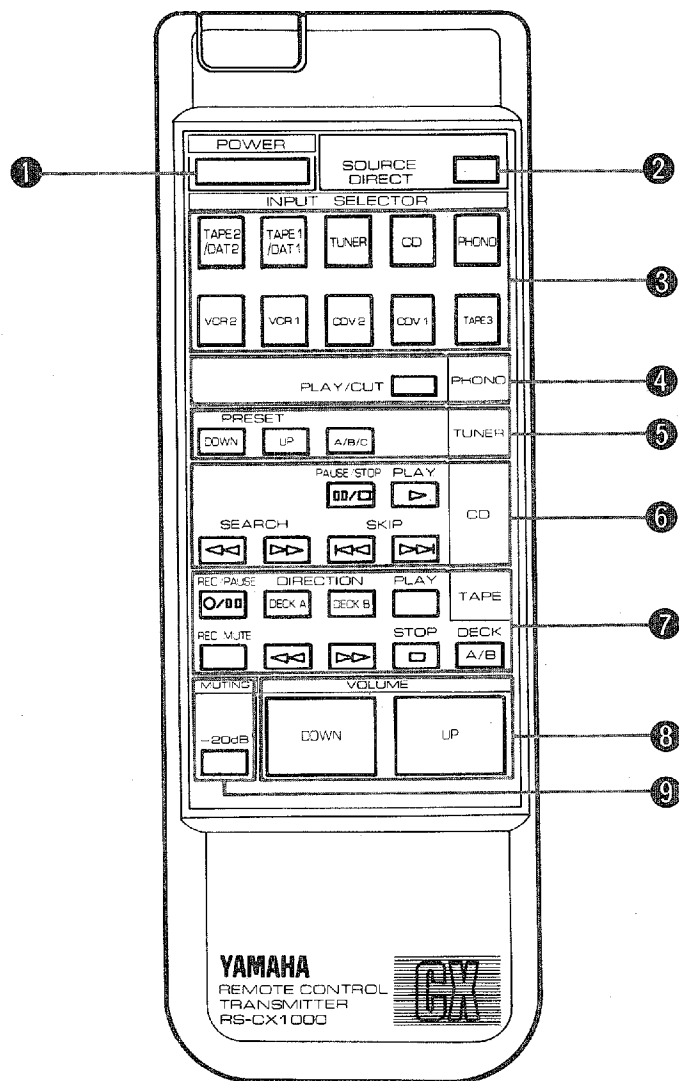

## KEYS AND THEIR FUNCTIONS

- ① **POWER key**  
Turns the CX-1000 on or off.
- ② **SOURCE DIRECT key**  
Has the same function as the front panel SOURCE DIRECT switch.
- ③ **INPUT SELECTOR keys**  
These allow you select the desired audio or video source directly by pushing the corresponding key. The name of the chosen source lights up on the front panel display.
- ④ **PHONO PLAY/CUT key**  
Starts or stops the connected turntable.
- ⑤ **TUNER keys**  
These keys let you select the desired preset station on the tuner.
  - A/B/C  
Switches between the two or three banks of station presets.
  - UP and DOWN  
Pressing these keys switches to the next higher (UP) or lower (DOWN) preset station.
- ⑥ **CD keys**
  - PLAY ▷  
Press to start CD playback.
  - PAUSE/STOP ◻◻◻◻  
Press once to temporarily stop playback (pause mode). Press once again to enter stop mode.
  - SEARCH ◁◁/▷▷  
Use these keys to search forward or backward.



- SKIP  $\lll$ / $\ggg$

Use these keys to skip to the beginning of the current, previous or next selection.

- ⑦ **TAPE keys**

- DECK A/B

If you are using a double cassette deck, this button switches between decks.

- DIRECTION (DECK A, DECK B)

Switches the tape direction between forward and backward. If a single deck is used, only DECK A is operative.

- PLAY, STOP,  $\lll$ ,  $\ggg$ , REC MUTE, REC/PAUSE

These buttons have the same functions as the corresponding switches on the tape deck's front panel.

- ⑧ **VOLUME keys**

Use these to raise (UP) or lower (DOWN) the volume of the CX-1000.

- ⑨ **MUTING key**

Like the front panel MUTING switch, this key mutes volume by 20dB. Press again to restore normal volume.

## REMOTE CONTROL RANGE

The transmitter can be used from a distance of up to about 7 meters (23 feet) from the control amplifier and must be aimed in its direction for proper operation.

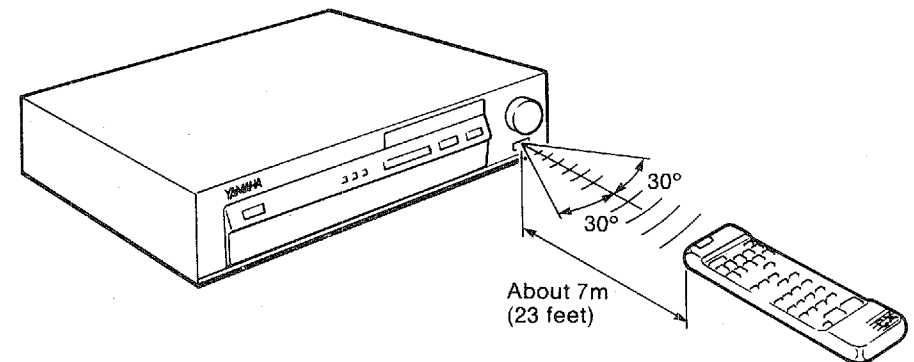

## BATTERY REPLACEMENT

When you notice that the remote control no longer works from greater distances, replace the batteries, observing the following precautions:

- Replace weak batteries before they run down completely.
- Always replace both batteries with new ones.
- Do not use different kinds of batteries at the same time.
- If battery electrolyte has leaked into the battery compartment, wipe it off completely before installing new batteries.
- Never disassemble, heat or throw discarded batteries into a fire. Dispose of them properly.

# TROUBLESHOOTING

Before assuming that your amplifier is faulty, check the following list. If you still have any doubts or questions, contact your nearest YAMAHA dealer.

Symptom	Possible cause	Remedy
<b>No power even when the POWER switch is ON.</b>	● The power cord is not plugged in securely.	● Plug in securely.
<b>No sound is heard.</b>	● The wrong source is selected.	● Select the desired source with the INPUT SELECTOR.
	● Power amp connections are not secure.	● Plug in connection cord, properly.
	● Source input connections are not secure.	● Plug in connection cord, properly.
<b>One channel sounds louder than the other.</b>	● Left/right channels out of balance.	● Adjust the BALANCE control.
<b>Sound from MC cartridge too low.</b>	● PHONO type/impedance selector set to MM.	● Set this switch to an MC position.
<b>A loud humming sound is heard when PHONO is selected.</b>	● Turntable is not properly grounded.	● Connect the turntable's ground wire to GND (or disconnect if this gives better results).
<b>Recording not possible.</b>	● REC OUT selector improperly set.	● Switch REC OUT to the source you want to record.
<b>TONE CONTROLS, LOUDNESS control does not operate.</b>	● The SOURCE DIRECT SWITCH is ON.	● Turn off the switch.

# SPECIFICATIONS

<b>Input Sensitivity/Impedance</b>	
PHONO MC	100 $\mu$ V/10, 100, 1k $\Omega$
PHONO MM	2.5mV/1k $\Omega$ , 47k $\Omega$ (220p, 330p)
CD/VIDEO/TUNER/AUX/TAPE/VCR	150mV/47k $\Omega$
<b>Input Sensitivity (New IHF)</b>	
PHONO MC	33 $\mu$ V
PHONO MM	0.83mV
CD/VIDEO/TUNER/AUX/TAPE/VCR	50mV
<b>Maximum-Input Signal</b>	
1kHz, 0.05% THD, PHONO MC	8.5mV
1kHz, 0.05% THD, PHONO MM	190mV
<b>Output Level/Impedance</b>	
REC OUT	150mV/1k $\Omega$
PRE OUT	1.5V/47 $\Omega$
<b>Maximum Voltage Output</b>	
20Hz ~ 20kHz, 1% THD, PRE OUT	12V
<b>Headphone Jack Rated Output/Impedance</b>	
RL = 100 ohms	4.5V/100 $\Omega$
<b>Frequency Response</b>	
CD/VIDEO/TUNER/AUX/TAPE/VCR (20Hz ~ 20kHz) +0, -0.2dB	
<b>RIAA Equalization Deviation</b>	
PHONO MC/MM	$\pm$ 0.2dB
<b>Total Harmonic Distortion (20Hz ~ 20kHz)</b>	
PHONO MC to REC OUT, 1.5V	0.002%
PHONO MM to REC OUT, 1.5V	0.001%
CD/VIDEO/TUNER/AUX/TAPE/VCR to PRE OUT, 1.5V	0.001%
<b>Intermodulation Distortion</b>	
PRE OUT, 3V	0.002%
<b>Signal to Noise Ratio (IHF-A-Network)</b>	
PHONO MC (500 $\mu$ V Input Shorted)	91dB
PHONO MM (5mV Input Shorted)	95dB
CD/VIDEO/TUNER/AUX/TAPE/VCR (Shorted)	106dB
<b>Signal to Noise Ratio (New IHF)</b>	
PHONO MC	81dB
PHONO MM	83dB
CD/VIDEO/TUNER/AUX/TAPE/VCR	103dB

<b>Input Equivalent Noise</b>		- 157dBV
		- 138dBV
<b>Residual Noise (IHF-A-Network)</b>		$\leq$ 1.5 $\mu$ V
<b>Channel Separation</b>		
PHONO MC, MM 1kHz/10kHz Input Shorted		80dB/70dB
(1kHz/10kHz CD/VIDEO/TUNER/AUX/TAPE/VCR 5.1k $\Omega$ terminated)		90dB/69.5dB
<b>Tone Control Characteristics</b>		
BASS	boost/cut	$\pm$ 10dB (20Hz)
	turnover frequency	350Hz
TREBLE	boost/cut	$\pm$ 10dB (20kHz)
	turnover frequency	3.5kHz
MID	control range	$\pm$ 10dB (1kHz)
	center frequency	1kHz
<b>Filter Characteristics</b>		
Subsonic		15Hz, 12dB/oct
<b>Continuous Loudness Control (Level related equalization)</b>		
Attenuation		- 40dB (1kHz)
<b>Audio Muting</b>		- 20dB
<b>Gain tracking error (0 ~ -60dB)</b>		$\leq$ 2dB
<b>Power Supply</b>		
General		AC110/120/220/240V, 60/50Hz
Australia, U.K.		AC240V, 50Hz
European		AC220V, 50Hz
<b>Power Consumption</b>		45W
<b>AC Outlet</b>		
Switched x 1		200W max.
<b>Dimensions (W x H x D)</b>		435 x 129.5 x 400mm (17-1/8" x 5-3/32" x 15-3/4")
<b>Weight</b>		11.5kg

Specifications subject to change without notice.

**YAMAHA**

YAMAHA CORPORATION  
PO Box 1, Hamamatsu, Japan

BW66b CR  Printed in Japan