



DIGITAL MIXING SYSTEM

RIVAGE

PM5

CONTROL SURFACE

CS-R5

Owner's Manual

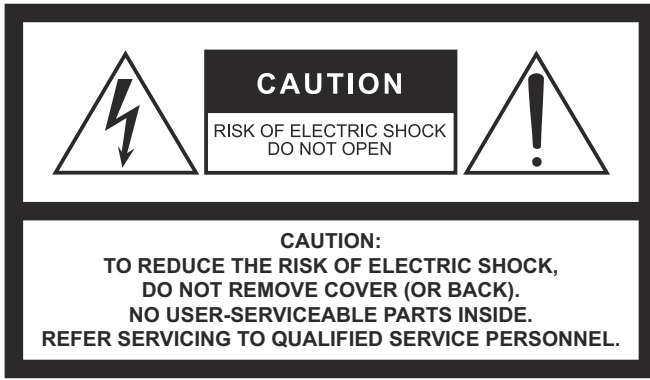

The above warning is located on the rear of the unit.



L'avertissement ci-dessus est situé sur l'arrière de l'unité.

Explanation of Graphical Symbols Explication des symboles



The lightning flash with arrowhead symbol within an equilateral triangle is intended to alert the user to the presence of uninsulated "dangerous voltage" within the product's enclosure that may be of sufficient magnitude to constitute a risk of electric shock to persons.
L'éclair avec une flèche à l'intérieur d'un triangle équilatéral est destiné à attirer l'attention de l'utilisateur sur la présence d'une « tension dangereuse » non isolée à l'intérieur de l'appareil, pouvant être suffisamment élevée pour constituer un risque d'électrocution.



The exclamation point within an equilateral triangle is intended to alert the user to the presence of important operating and maintenance (servicing) instructions in the literature accompanying the product.
Le point d'exclamation à l'intérieur d'un triangle équilatéral est destiné à attirer l'attention de l'utilisateur sur la présence d'instructions importantes sur l'emploi ou la maintenance (réparation) de l'appareil dans la documentation fournie.

IMPORTANT SAFETY INSTRUCTIONS

- 1 Read these instructions.
- 2 Keep these instructions.
- 3 Heed all warnings.
- 4 Follow all instructions.
- 5 Do not use this apparatus near water.
- 6 Clean only with dry cloth.
- 7 Do not block any ventilation openings. Install in accordance with the manufacturer's instructions.
- 8 Do not install near any heat sources such as radiators, heat registers, stoves, or other apparatus (including amplifiers) that produce heat.
- 9 Do not defeat the safety purpose of the polarized or grounding-type plug. A polarized plug has two blades with one wider than the other. A grounding type plug has two blades and a third grounding prong. The wide blade or the third prong are provided for your safety. If the provided plug does not fit into your outlet, consult an electrician for replacement of the obsolete outlet.
- 10 Protect the power cord from being walked on or pinched particularly at plugs, convenience receptacles, and the point where they exit from the apparatus.
- 11 Only use attachments/accessories specified by the manufacturer.
- 12 Use only with the cart, stand, tripod, bracket, or table specified by the manufacturer, or sold with the apparatus. When a cart is used, use caution when moving the cart/apparatus combination to avoid injury from tip-over.
- 13 Unplug this apparatus during lightning storms or when unused for long periods of time.
- 14 Refer all servicing to qualified service personnel. Servicing is required when the apparatus has been damaged in any way, such as power-supply cord or plug is damaged, liquid has been spilled or objects have fallen into the apparatus, the apparatus has been exposed to rain or moisture, does not operate normally, or has been dropped.



WARNING

TO REDUCE THE RISK OF FIRE OR ELECTRIC SHOCK, DO NOT EXPOSE THIS APPARATUS TO RAIN OR MOISTURE.

(UL60065_03)

PRÉCAUTIONS CONCERNANT LA SÉCURITÉ

- 1 Lire ces instructions.
- 2 Conserver ces instructions.
- 3 Tenir compte de tous les avertissements.
- 4 Suivre toutes les instructions.
- 5 Ne pas utiliser ce produit à proximité d'eau.
- 6 Nettoyer uniquement avec un chiffon propre et sec.
- 7 Ne pas bloquer les orifices de ventilation. Installer l'appareil conformément aux instructions du fabricant.
- 8 Ne pas installer l'appareil à proximité d'une source de chaleur comme un radiateur, une bouche de chaleur, un poêle ou tout autre appareil (y compris un amplificateur) produisant de la chaleur.
- 9 Ne pas modifier le système de sécurité de la fiche polarisée ou de la fiche de terre. Une fiche polarisée dispose de deux broches dont une est plus large que l'autre. Une fiche de terre dispose de deux broches et d'une troisième pour le raccordement à la terre. Cette broche plus large ou cette troisième broche est destinée à assurer la sécurité de l'utilisateur. Si la fiche équipant l'appareil n'est pas compatible avec les prises de courant disponibles, faire remplacer les prises par un électricien.
- 10 Acheminer les cordons d'alimentation de sorte qu'ils ne soient pas piétinés ni coincés, en faisant tout spécialement attention aux fiches, prises de courant et au point de sortie de l'appareil.
- 11 Utiliser exclusivement les fixations et accessoires spécifiés par le fabricant.
- 12 Utiliser exclusivement le chariot, le stand, le trépied, le support ou la table recommandés par le fabricant ou vendus avec cet appareil. Si l'appareil est posé sur un chariot, déplacer le chariot avec précaution pour éviter tout risque de chute et de blessure.
- 13 Débrancher l'appareil en cas d'orage ou lorsqu'il doit rester hors service pendant une période prolongée.
- 14 Confier toute réparation à un personnel qualifié. Faire réparer l'appareil s'il a subi tout dommage, par exemple si la fiche ou le cordon d'alimentation est endommagé, si du liquide a coulé ou des objets sont tombés à l'intérieur de l'appareil, si l'appareil a été exposé à la pluie ou à de l'humidité, si l'appareil ne fonctionne pas normalement ou est tombé.



AVERTISSEMENT

POUR RÉDUIRE LES RISQUES D'INCENDIE OU DE DÉCHARGE ÉLECTRIQUE, N'EXPOSEZ PAS CET APPAREIL À LA PLUIE OU À L'HUMIDITÉ.

(UL60065_03)

FCC INFORMATION (U.S.A.)

1. IMPORTANT NOTICE: DO NOT MODIFY THIS UNIT!

This product, when installed as indicated in the instructions contained in this manual, meets FCC requirements. Modifications not expressly approved by Yamaha may void your authority, granted by the FCC, to use the product.

2. IMPORTANT:

When connecting this product to accessories and/or another product use only high quality shielded cables. Cable/s supplied with this product MUST be used. Follow all installation instructions. Failure to follow instructions could void your FCC authorization to use this product in the USA.

3. NOTE:

This product has been tested and found to comply with the requirements listed in FCC Regulations, Part 15 for Class "B" digital devices. Compliance with these requirements provides a reasonable level of assurance that your use of this product in a residential environment will not result in harmful interference with other electronic devices. This equipment generates/uses radio frequencies and, if not installed and used according to the instructions found in the users manual, may cause interference harmful to the operation of other electronic devices. Compliance with FCC regulations does

not guarantee that interference will not occur in all installations. If this product is found to be the source of interference, which can be determined by turning the unit "OFF" and "ON", please try to eliminate the problem by using one of the following measures:

Relocate either this product or the device that is being affected by the interference.

Utilize power outlets that are on different branch (circuit breaker or fuse) circuits or install AC line filter/s.

In the case of radio or TV interference, relocate/reorient the antenna. If the antenna lead-in is 300 ohm ribbon lead, change the lead-in to co-axial type cable.

If these corrective measures do not produce satisfactory results, please contact the local retailer authorized to distribute this type of product. If you can not locate the appropriate retailer, please contact Yamaha Corporation of America, Electronic Service Division, 6600 Orangethorpe Ave, Buena Park, CA90620

The above statements apply ONLY to those products distributed by Yamaha Corporation of America or its subsidiaries.

(class B)

COMPLIANCE INFORMATION STATEMENT (Supplier's declaration of conformity procedure)

Responsible Party : Yamaha Corporation of America
Address : 6600 Orangethorpe Ave., Buena Park, Calif. 90620
Telephone : 714-522-9011
Type of Equipment : Control Surface
Model Name : CS-R5

This device complies with Part 15 of the FCC Rules.

Operation is subject to the following two conditions:

- 1) this device may not cause harmful interference, and
- 2) this device must accept any interference received including interference that may cause undesired operation.

(FCC SDoC)

This product contains a battery that contains perchlorate material.
Perchlorate Material—special handling may apply,
See www.dtsc.ca.gov/hazardouswaste/perchlorate.

* This applies only to products distributed by YAMAHA CORPORATION OF AMERICA. (Perchlorate)

Information for users on collection and disposal of old equipment:



This symbol on the products, packaging, and/or accompanying documents means that used electrical and electronic products should not be mixed with general household waste. For proper treatment, recovery and recycling of old products, please take them to applicable collection points, in accordance with your national legislation.

By disposing of these products correctly, you will help to save valuable resources and prevent any potential negative effects on human health and the environment which could otherwise arise from inappropriate waste handling.

For more information about collection and recycling of old products, please contact your local municipality, your waste disposal service or the point of sale where you purchased the items.

For business users in the European Union:

If you wish to discard electrical and electronic equipment, please contact your dealer or supplier for further information.

Information on Disposal in other Countries outside the European Union:

This symbol is only valid in the European Union. If you wish to discard these items, please contact your local authorities or dealer and ask for the correct method of disposal.

(weee_eu_en_02)

PRECAUTIONS

PLEASE READ CAREFULLY BEFORE PROCEEDING

Please keep this manual in a safe place for future reference.

This product is suitable for use in a hall or event. Do not use for any purposes other than the one intended. Individuals who are not familiar with the proper way to handle this type of product, or individuals who cannot handle this type of product in accordance with the instructions in this manual, should be supervised by responsible persons to ensure safety.



WARNING

Always follow the basic precautions listed below to avoid the possibility of serious injury or even death from electrical shock, short-circuiting, damages, fire or other hazards. These precautions include, but are not limited to, the following:

If you notice any abnormality

- If any of the following problems occur, immediately turn off the power switch and disconnect the electric plug from the outlet.
 - The power cord or plug becomes frayed or damaged.
 - Unusual smells or smoke are emitted.
 - Some object, or water has been dropped into the product.
 - There is a sudden loss of sound during use of the product.
 - Cracks or other visible damage appear on the product.
 Then have the product inspected or repaired by qualified Yamaha service personnel.

Power supply/Power cord

- Do not place the power cord near heat sources such as heaters or radiators, and do not excessively bend or otherwise damage the cord, place heavy objects on it, or place it in a position where anyone could walk on, trip over, or roll anything over it.
- Only use the voltage specified as correct for the product. The required voltage is printed on the name plate of the product.
- Use only the supplied power cord/plug. If you intend to use the product in an area other than in the one you purchased, the included power cord may not be compatible. Please check with your Yamaha dealer.
- Check the electric plug periodically and remove any dirt or dust which may have accumulated on it.
- Make sure to fully insert the electric plug to prevent electric shocks or fire.
- This product receives power from multi sources. When setting up the product, make sure that the AC outlet you are using is easily accessible. If some problem or malfunction occurs, immediately turn off the power switches and disconnect all plugs from the AC outlet. Even when the power switches are turned off, as long as the power cord is connected to the AC outlet, the product will not be disconnected from the power source.



- Remove the electric plug from the outlet when the product is not to be used for extended periods of time.
- Do not touch the product or the electric plug during an electrical storm.
- Be sure to connect to an appropriate outlet with a protective grounding connection. Improper grounding can result in electrical shock, fire, or damage.

Do not open

- This product contains no user-serviceable parts. Do not attempt to disassemble the internal parts or modify them in any way.

Water warning/Fire warning

- Do not expose the product to rain, use it near water or in damp or wet conditions, or place on it any containers (such as vases, bottles or glasses) containing liquids which might spill into any openings.
- Never insert or remove the electric plug with wet hands.
- Do not place any burning items or open flames near the product, since they may cause a fire.

Hearing loss

- Before turning the power of all devices on or off, make sure that all volume levels are set to the minimum. Failing to do so may result in hearing loss, electric shock, or device damage.
- When turning on the AC power in your audio system, always turn on the power amplifier LAST, to avoid hearing loss and speaker damage. When turning the power off, the power amplifier should be turned off FIRST for the same reason.
- Do not use headphones for a long period of time at a high or uncomfortable volume level, since this can cause permanent hearing loss. If you experience any hearing loss or ringing in the ears, consult a physician.



CAUTION

Always follow the basic precautions listed below to avoid the possibility of physical injury to you or others. These precautions include, but are not limited to, the following:

Power supply/Power cord

- When removing the electric plug from the product or an outlet, always hold the plug itself and not the cord. Pulling by the cord can damage it.

Location and connection

- Do not place the product in an unstable position or a location with excessive vibration, where it might accidentally fall over and cause injury.
- Keep this product out of reach of children. This product is not suitable for use in locations where children are likely to be present.
- Do not block the vents. This product has ventilation holes at the rear/under the front to prevent the internal temperature from becoming too high. In particular, do not place the product on its side or upside down. Inadequate ventilation can result in overheating, possibly causing damage to the product(s), or even fire.

- Do not place the product in a location where it may come into contact with corrosive gases or salt air. Doing so may result in malfunction.
- Before moving the product, remove all connected cables.
- When transporting or moving the product, always use three or more people. Attempts to lift this product by only one or two individuals may result in injuries, such as back injuries, or cause the product to be dropped and broken, which could lead to other injuries.

Maintenance

- Remove the power plug from the AC outlet when cleaning the product.

Handling caution

- Do not rest your weight on the product or place heavy objects on it.

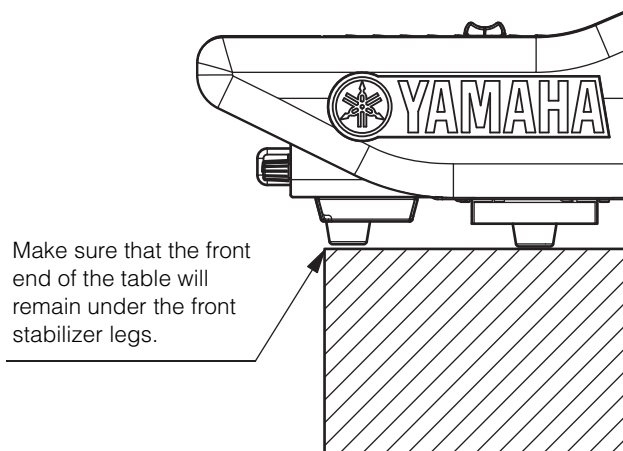

Backup battery

- Do not replace the backup battery by yourself. Doing so may cause an explosion and/or damage to the product(s). When the backup battery needs to be replaced, "Low Battery" or "No Battery" will appear on the display. In this case, contact your Yamaha dealer and have qualified Yamaha service personnel replace the backup battery.

NOTICE

To avoid the possibility of malfunction/damage to the product, damage to data, or damage to other property, follow the notices below.

Handling and maintenance

- Do not connect this product to public Wi-Fi and/or Internet directly. Only connect this product to the Internet through a router with strong password-protections. Consult your router manufacturer for information on security best practices.
- Do not use the product in the vicinity of a TV, radio, or other electric products. Otherwise, the product, TV, or radio may generate noise.
- Do not expose the product to excessive dust or vibration, or extreme cold or heat, in order to prevent the possibility of panel disfiguration, unstable operation, or damage to the internal components.
- Do not install in locations where temperature changes are severe. Otherwise, condensation may form on the inside or the surface of the product, causing it to break.
- If there is reason to believe that condensation might have occurred, leave the product for several hours without turning on the power until the condensation has completely dried out, in order to prevent possible damage.
- Do not place vinyl, plastic or rubber objects on the product, since this might cause alteration or discoloration of the panel.
- When cleaning the product, use a dry and soft cloth. Do not use paint thinners, solvents, cleaning fluids, or chemical-impregnated wiping cloths, since this might cause alteration or discoloration.
- Do not apply oil, grease, or contact cleaner to the faders. Doing so might cause problems with electrical contact or fader motion.

Saving data

- If a "Low Battery" or "No Battery" message appears, keep the power turned on and immediately transfer any data you want to save to a computer or other external storage product, to avoid data loss or damage.

Information

About copyrights

- Copying of commercially available musical data including but not limited to MIDI data and/or audio data is strictly prohibited except for your personal use.

About functions/data bundled with the product

- Even when the Power switches are in standby status (power lamp is off), electricity is still flowing to the product at the minimum level. When you are not using the product for a long time, make sure you unplug the power cord from the wall AC outlet.
- XLR-type connectors are wired as follows (IEC60268 standard): pin 1: ground, pin 2: hot (+), and pin 3: cold (-).
- Supply of this product does not convey a license nor imply any right to distribute content created with this product in revenue-generating broadcast systems (terrestrial, satellite, cable and/or other distribution channels), streaming applications (via Internet, intranets and/or other networks), other content distribution systems (pay-audio or audio-on-demand applications and the like) or on physical media (compact discs, digital versatile discs, semiconductor chips, hard drives, memory cards and the like). An independent license for such use is required. For details, please visit <http://mp3licensing.com>.

About this manual

- The illustrations and screens as shown in this manual are for instructional purposes only.
- Yamaha Corporation make no representations or warranties with regard to the use of the software and documentation and cannot be held responsible for the results of the use of this manual and the software.
- Windows is a registered trademark of Microsoft® Corporation in the United States and other countries.
- Apple, Mac, and iPad are trademarks of Apple Inc., registered in the U.S. and other countries.
- The company names and product names in this manual are the trademarks or registered trademarks of their respective companies.
- Software may be revised and updated without prior notice.

About disposal

- This product contains recyclable components. When disposing of this product, please contact the appropriate local authorities.

Yamaha cannot be held responsible for damage caused by improper use or modifications to the product, or data that is lost or destroyed.

Contents

PRECAUTIONS.....4

Introduction8

- About manuals..... 8
- About utility software..... 9
- Firmware updates 9
- Conventions in this manual..... 9
- Accessories..... 9

Part Names & Functions10

- Top panel 10
- Front panel 20
- Rear panel..... 21

Power Supply / Shutdown.....23

- Connecting to power sources..... 23
- Shutting down the power to
the unit..... 23

Installing and Removing Optional Cards24

- Installing a Mini-YGDAL card 24
- Removing the Mini-YGDAL card..... 24

Touch Screen25

- Basic touch screen operations 25
- On-screen user interface..... 25
- Viewing a touch screen 26

Other Operations27

- Initializing the unit to
factory default settings..... 27
- Adjusting the faders
(Calibration function)..... 27

Troubleshooting29

Specifications30

- General Specifications 30
- Audio Specifications 30
- Input/output Characteristics..... 31
- Pin Assignment Table 32
- Dimensional Diagrams 33

Index.....34

Introduction

Thank you for purchasing the Yamaha Control Surface CS-R5.

The CS-R5 is a control surface dedicated to the Yamaha RIVAGE PM5 series digital mixing system. This manual provides information regarding the basic functions and operations for mixing engineers and technical personnel at audio installation companies.

In order to take full advantage of this system's superior functionality and enjoy years of trouble-free use, please read this manual before you use the product. After you have read the manual, keep it in a safe place for future reference.

About manuals

- **CS-R5 Owner's Manual (this book)**
This guide also explains part names and functions on the panels of the CS-R5.
- **RIVAGE PM series Operation Manual**
The Operation Manual provides detailed explanations of all screens and functions, and includes step-by-step procedures and system set-up process to help you operate the RIVAGE PM series.
- **RIVAGE PM Editor Installation Guide**
This guide describes how to install the RIVAGE PM Editor.
- **RIVAGE PM StageMix User Guide**
This guide describes an iPad application that enables you to control the RIVAGE PM series system wirelessly.

Using the PDF manual

The RIVAGE PM series Operation Manual and the Editor Installation Guide are electronic files in PDF format. You can read this book on a computer. Use Acrobat Reader to read this book on screen, search for words very quickly, print specific pages, or click links to display sections of special interest. The ability to search for words, or to follow links directly to relevant sections in the document, are helpful attributes of this electronic file format. We encourage you to take advantage of these benefits.

You can download the latest Acrobat Reader application from the website listed below.

<http://www.adobe.com/>

All manuals can be downloaded from the Yamaha website. If necessary, you can review updated manual information, which is always posted in the Yamaha website.

<http://download.yamaha.com/>



Yamaha Eco-Label

Yamaha Eco-Label is a mark that certifies products of high environmental performance.

About utility software

The RIVAGE PM series can be used with a variety of utility software.

- **RIVAGE PM Editor**

This application software enables you to access the same functions that are available on the control surface. You can use your computer to perform off-line editing by preparing the RIVAGE PM series settings in advance, and to monitor and adjust those settings (on-line monitoring/operation).

- **RIVAGE PM StageMix**

StageMix enables you to use your iPad to wirelessly control the parameters of your Yamaha RIVAGE PM series digital mixing console. StageMix offers the sound engineer (who is away from the system) the freedom to control parameters remotely, while listening to the results from the vantage point of the performers.

Information on this software application is available on the Yamaha Pro Audio global website:

<http://www.yamahaproaudio.com/>

For information regarding how to download or install Editor or StageMix, as well as their various setting details, please refer to the website listed above or to the Installation Guide attached to the downloaded software program.

Firmware updates

You can update the unit firmware to improve operations, add functions, and correct possible malfunctions.

Details on updating the firmware are available on the following Yamaha Pro Audio global website:

<http://www.yamahaproaudio.com/>

For information on updating and setting up the unit, please refer to the firmware update guide available on the website.

Conventions in this manual

In this manual, switch-type controllers on the panel are called “keys.” Control knobs on the panel are called “knobs.” Some knobs rotate from a minimum value to a maximum value, while others rotate endlessly.

Virtual buttons displayed on the screen are called “buttons,” and virtual knobs are called “knobs.”

Controls located on the panel are enclosed in square brackets [] (e.g., [CUE] key) to distinguish them from virtual buttons and knobs displayed on screen. For certain controls, the name of the section appears before the brackets (e.g., SCENE MEMORY [STORE] key).

Accessories

- AC power cord × 2
(Multiple AC power cords which have different kinds of plug shapes may be included depending on the region.)
- Dust cover
- Nuendo Live (DAW software)
- Owner’s Manual (this book)

Part Names & Functions

Top panel

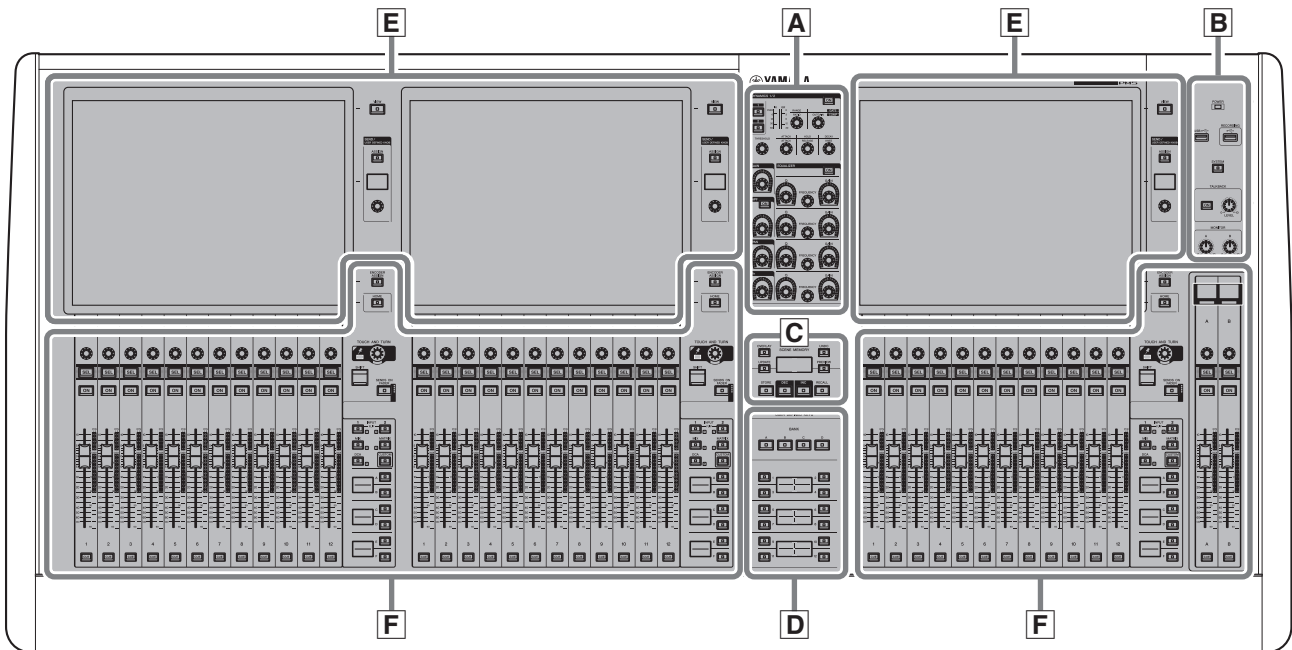

- A** Selected Channel section → page 11
- B** UTILITY section → page 13
- C** SCENE MEMORY section → page 14
- D** USER DEFINED KEYS section → page 15
- E** Touch Screen section → page 16
- F** Channel Strip section → page 17

A Selected Channel section

This section enables you to adjust parameters for the selected channel.

The knobs in the Selected Channel section feature the Touch Sense function.

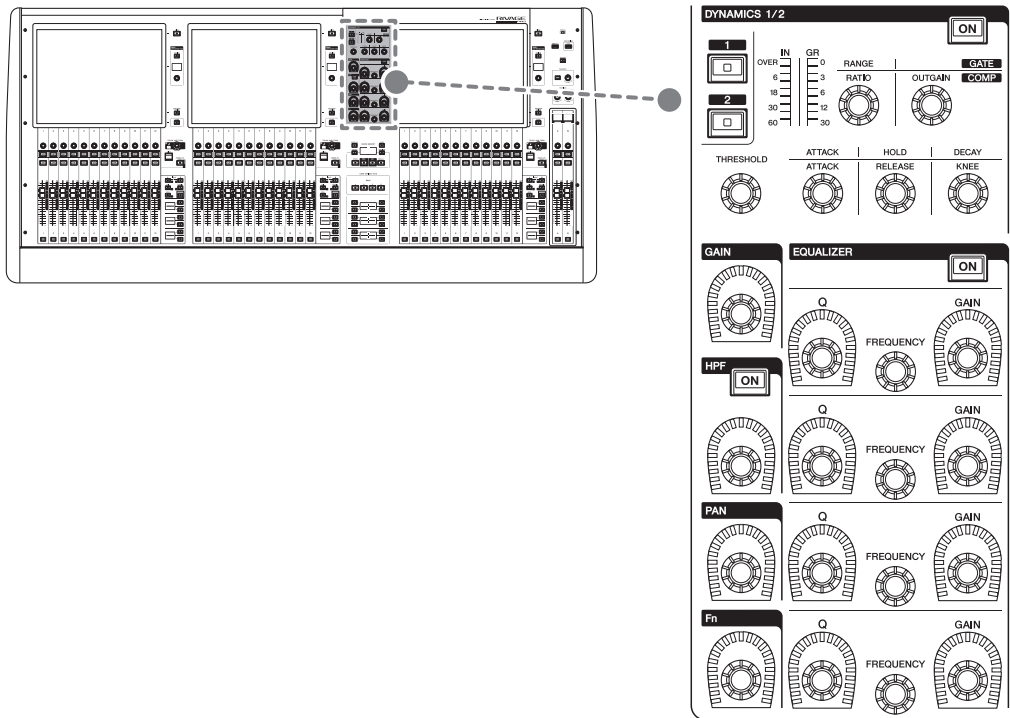

DYNAMICS 1/2

This section enables you to select Dynamics 1 or 2, and make detailed settings. You can also view the input level and the gain reduction of selected Dynamics.

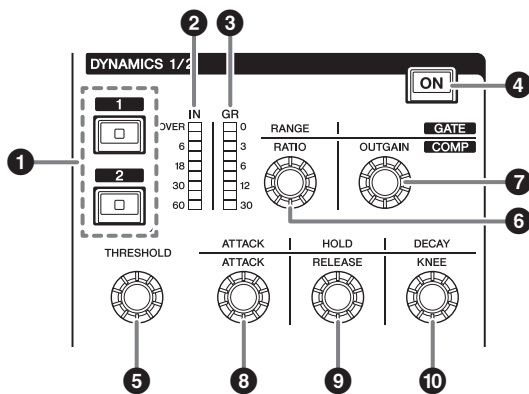

- ❶ **DYNAMICS [1]/[2] keys**
These enable selection of Dynamics 1 or 2.
- ❷ **DYNAMICS 1/2 IN LEDs**
Indicates the input level of selected Dynamics.
- ❸ **DYNAMICS 1/2 GR LEDs**
Indicates the gain reduction amount of selected Dynamics.
- ❹ **DYNAMICS 1/2 [ON] key**
Switches Dynamics on or off.

❺–❿ DYNAMICS 1/2 setting knobs

These knobs enable you to make detailed settings for Dynamics 1 or 2. The available knob functions vary depending on the type of selected Dynamics. For more information regarding the type of Dynamics, please refer to the RIVAGE PM series Operation Manual.

Dynamics processor type	❺	❻	❼	❽	❾	❿
GATE/DUCKING	THRESHOLD	RANGE	—	ATTACK	HOLD	DECAY
COMP/EXPANDER	THRESHOLD	RATIO	OUTGAIN	ATTACK	RELEASE	KNEE
DE-ESSER	THRESHOLD	FREQ	Q	—	—	TYPE

GAIN, HPF, PAN, Fn

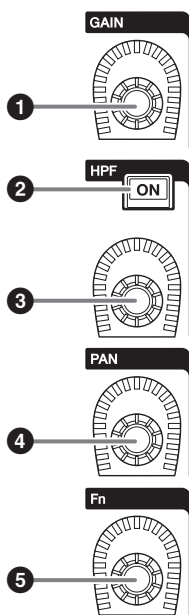

- ❶ **[GAIN] knob**
Controls the analog gain or digital gain.
- ❷ **HPF [ON] key**
Switches the HPF on or off.
- ❸ **[HPF] knob**
Adjusts the HPF cutoff frequency.
- ❹ **[PAN] knob**
Adjusts the panning of the signal sent to the stereo buses.
- ❺ **[Fn] (Function) knob**
Adjusts the specified parameter.

EQUALIZER

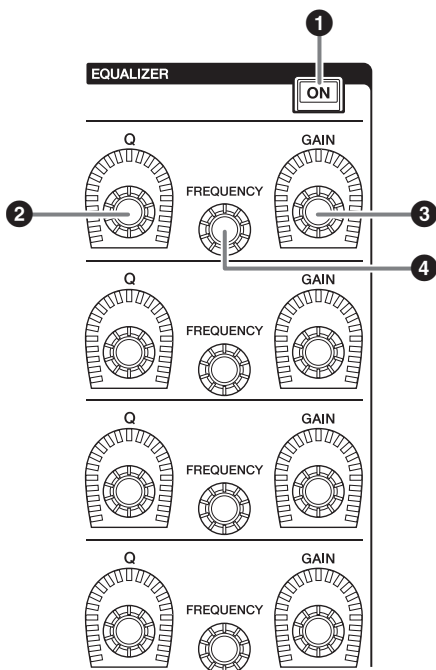

- ❶ **EQUALIZER [ON] key**
Switches EQ on or off.
- ❷ **EQUALIZER [Q] knobs**
Specify the Q value.
- ❸ **EQUALIZER [GAIN] knobs**
Adjust the gain.
- ❹ **EQUALIZER [FREQUENCY] knobs**
Adjust the frequency.

B UTILITY section

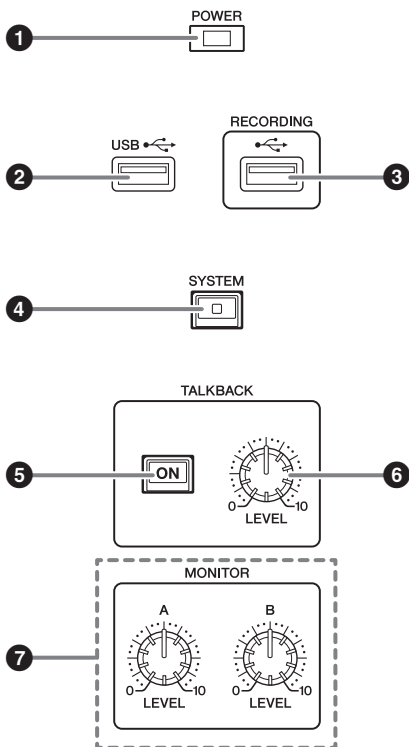
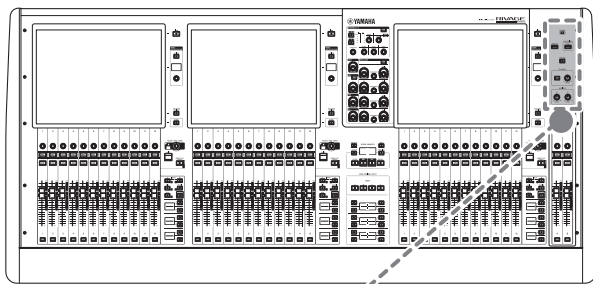

1 POWER Indicator

Lights when AC power to the unit is ON. If both power switches A and B are turned on, this indicator will light green. If either power switch A or B is turned on, it will light red. If the RIVAGE PM5 system is not started, it will light orange.

2 USB port

Enables you to connect a USB device (such as a mouse, keyboard, or USB flash drive). Use a USB flash drive to store the system's internal data and to load the stored data into the system.

■ Supported USB flash drive format

The FAT16 and FAT32 formats are supported.

■ Write Protection

Some USB flash drives feature write protection that prevents data from being erased inadvertently.

If your USB flash drive contains important data, we suggest that you use write protection to prevent accidental erasure.

On the other hand, you will need to make sure that your USB flash drive's write-protect setting is turned off before you save data onto the USB flash drive.

For the latest information on which USB flash drives can be used with the system, visit the Yamaha Pro Audio global website at:

<http://www.yamahaproaudio.com/>

NOTICE

Do not remove the USB flash drive from the USB connector or turn off the power to the unit while the unit is accessing data, e.g., saving, loading or deleting data.

Doing so may damage your flash drive, or may damage the data in the unit or on your media device.

3 RECORDING port

Enables you to connect a USB flash drive to record and play back audio files. Supported file formats include WAV and MP3.

For the latest information on what USB flash drives can be used with the system, visit the Yamaha Pro Audio global website at:

<http://www.yamahaproaudio.com/>

4 [SYSTEM] key

Press this key to display information about the RIVAGE PM5 system on the touch screens.

Press and hold down the key for two seconds or longer to shut down the control section of the console (see page 23). Be sure to shut down before turning off the power switches.

5 TALKBACK [ON] key

Switches the Talkback function on or off.

6 TALKBACK [LEVEL] knob

Adjusts the Talkback input level.

7 MONITOR A/B [LEVEL] knobs

Adjust the output level of the monitoring signals.

C SCENE MEMORY section

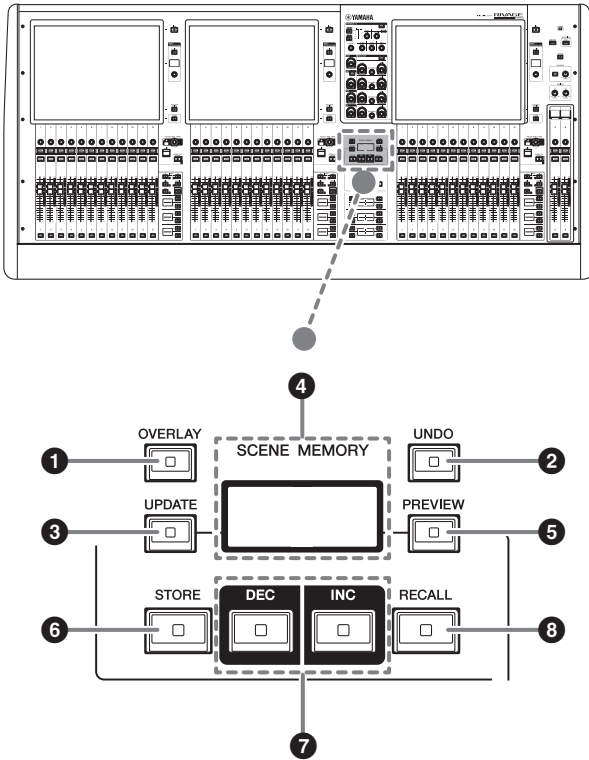

- 1 [OVERLAY] key**
Press this button to display the OVERLAY SETTING screen.

While pressing and holding down the [SHIFT] key (see **5** on page 17), press the [OVERLAY] key to switch Overlay on or off.

While Overlay is turned on, press and hold down the [OVERLAY] key to enter Overlay edit mode.

- 2 [UNDO] key**
Cancels the most recent scene operation of storing, recalling or updating a scene.
After you cancel the operation by pressing the [UNDO] key, you can “redo” the canceled operation by pressing the [UNDO] key again.

NOTE

Using the [UNDO] key will not undo an operation to store a new scene.

- 3 [UPDATE] key**
Updates scene data by overwriting the current scene (that has been recalled most recently) with the current mix data.

- 4 SCENE MEMORY display**
Indicates the selected scene memory.

- 5 [PREVIEW] key**
Switches Preview mode on or off.

- 6 [STORE] key**
Stores the current scene settings to the selected scene memory. If you select the existing scene as the store destination, it will be overwritten.

NOTE

Use the [UPDATE] key to overwrite the current scene.

- 7 [INC]/[DEC] keys**
Enable you to select the scene number of a scene that you want to store or recall.

NOTE

- If you select a scene other than the current scene, the scene number on the LCD display will flash.
- Press the [INC] and [DEC] keys simultaneously to return to the current scene.

- 8 [RECALL] key**
Enables you to recall a selected scene from scene memory.

D USER DEFINED KEYS section

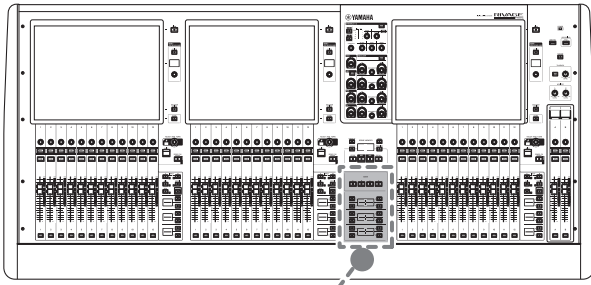

USER DEFINED KEYS

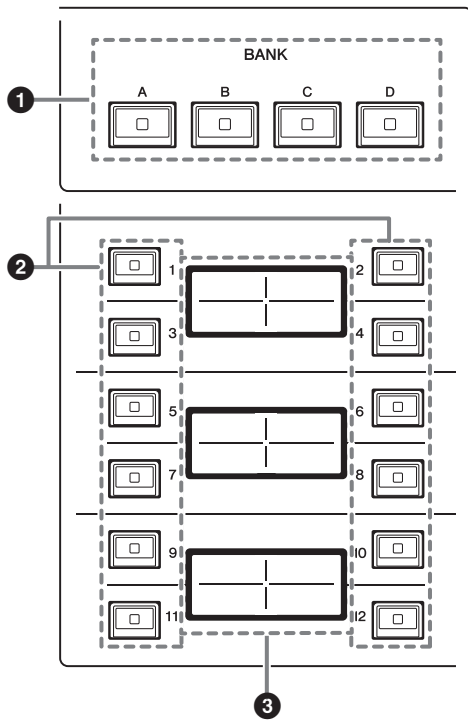

- 1 USER DEFINED [A]/[B]/[C]/[D] BANK keys**
Select the bank ([A], [B], [C], or [D]) for the USER DEFINED knobs or USER DEFINED keys.
- 2 USER DEFINED keys [1]–[12]**
Control the functions as assigned by the user.
- 3 USER DEFINED KEYS displays**
Indicate the functions assigned to the USER DEFINED keys.

E Touch Screen section (Bay L, Bay C, Bay R)

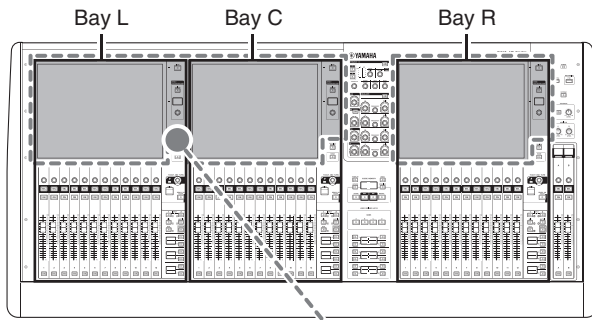

Bay

A “bay” consists of a group of 12 faders located across the Touch Screen section and the Channel Strip section.

The CS-R5 contains three bays. You can control these bays independently.

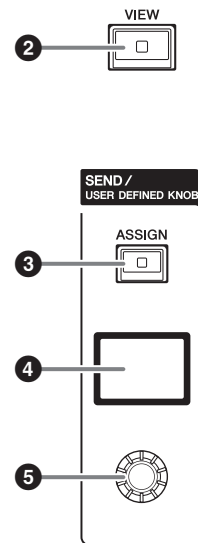
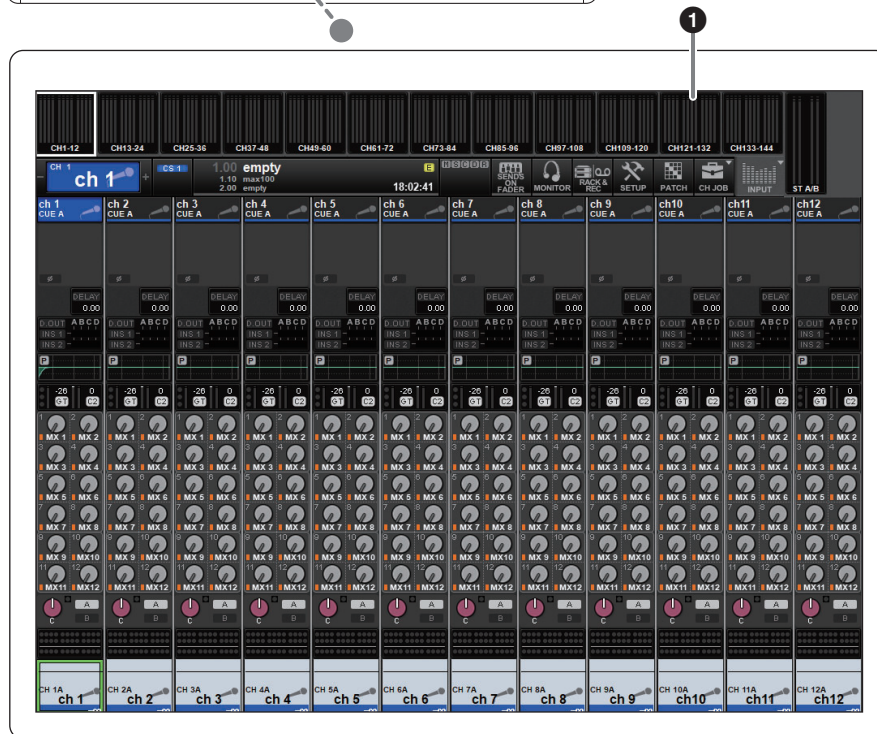

1 Touch screen

This is a multi-touch screen that you can operate by touching it with your finger to select menus or set parameters. The touch screen will not respond correctly if you are wearing gloves.

NOTICE

Never use a sharp or pointed object such as your fingernail to operate the touch screens. Doing so may scratch the screens and render the touch screens inoperable.

NOTE

- If the touch screens become dirty, wipe them with a soft dry cloth.
- Before use, be sure to remove the transparent film applied to the touch screens to protect them during transport.

2 [VIEW] key

Recalls and toggles between the OVERVIEW and SELECTED CHANNEL VIEW screens.

SEND / USER DEFINED KNOB

This section enables you to specify the send bus destination, and adjust the send level for the corresponding bus. You can also switch to the USER DEFINED KNOB function to control the assigned function.

3 [ASSIGN] key

Displays a screen that enables you to specify the send destination bus and switch to the USER DEFINED KNOB function.

The factory default bus is set to SEND TO MIX 1.

4 Display

While the SEND function is enabled, the display indicates the selected bus and its send level.

While the USER DEFINED KNOB function is enabled, the display indicates the assigned function parameter and its value.

5 SEND / USER DEFINED knob

Adjusts the send level for the corresponding bus while the SEND function is enabled.

Enables you to control the assigned function while the USER DEFINED KNOB function is enabled.

F Channel Strip section (Bay L, Bay C, Bay R)

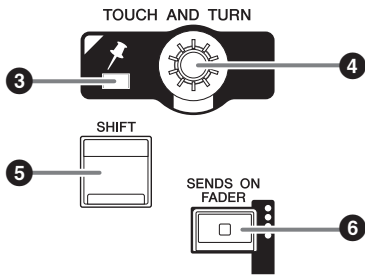
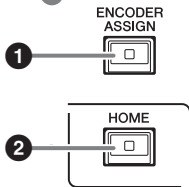
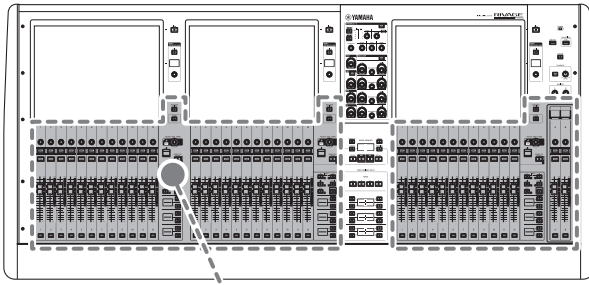

- 1 [ENCODER ASSIGN] key**
Displays a screen that enables you to switch between the Screen Encoder function and the Channel Encoder function. You can use only the Channel Encoder function for channel strips A and B.
- 2 [HOME] key**
Recalls a group of settings for the bay. Press and hold down this key to store the following settings:

 - Layers and current screen data
 - Selected channel/parameters on screen
- 3 PIN indicator**
Lights up when the Pinning function for the [TOUCH AND TURN] knob is turned on. (This feature will be supported by a future update.)
- 4 [TOUCH AND TURN] knob**
Controls the parameter of the knob you selected by touching the touch screen.
- 5 [SHIFT] key**
Combine with another key to perform a certain function.
The following table shows an example of using the [SHIFT] key combined with another key. For more information, please refer to the RIVAGE PM series Operation Manual.

Procedure	Function
Press and hold down the [SHIFT] key and press multiple [SEL] keys.	Temporary link. Controlling the parameter of multiple channels simultaneously.
- 6 [SENDS ON FADER] key**
Turns SENDS ON FADER mode on and off. While SENDS ON FADER mode is enabled, the input faders will control the send levels of the corresponding buses.

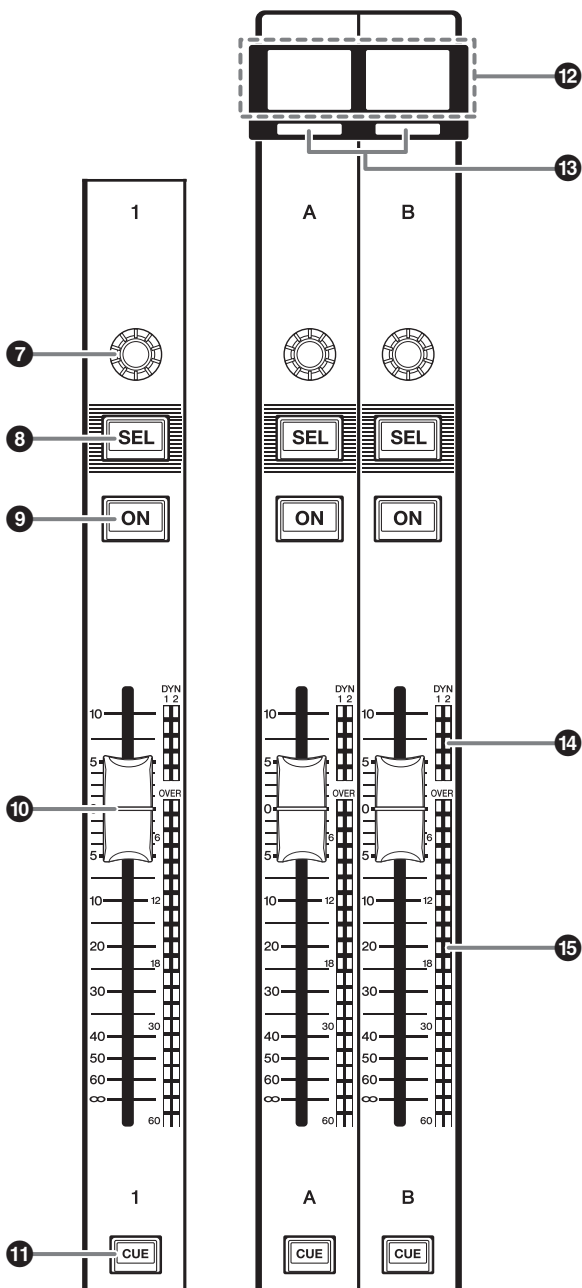

7 Strip encoder

You can use the Screen Encoder function and the Channel Encoder function for channel strips 1–12. Use the [ENCODER ASSIGN] key (see 1 on page 17) to toggle between these two functions. You can use only the Channel Encoder function for channel strips A and B.

- **Screen Encoder function:**

Up to 12 parameters can be assigned by selecting controls on the screen.

- **Channel Encoder function:**

Parameters for 12 channels on the channel strips can be assigned. Use the [ENCODER ASSIGN] key (see 1 on page 17) to toggle between these two functions.

8 [SEL] key

Enables you to select the channel that will be controlled in the Channel Strip section or on the display. When the channel is selected, the key LED will light.

9 [ON] key

Switches the channel on or off. If the channel is on, the key LED will light. If the channel is in a mute group, the key indicator will flash. In SENDS ON FADER mode (see 6 [SENDS ON FADER] key on page 17), this key works as an on/off switch for signals sent from each channel to the currently-selected MIX/MATRIX bus.

10 Fader

This is a touch-sensitive 100 mm motorized fader. In SENDS ON FADER mode, this fader adjusts the send level of the signal sent from each channel to the currently-selected MIX/MATRIX bus.

11 [CUE] key

Selects the channel for cue.

12 Channel name display

Indicates the channel name, fader value, etc.

13 Channel color indicator

Indicates the channel color.

14 Dynamics LEDs

Indicate the status of Dynamics 1 and 2.

15 Meter LEDs

Indicate the channel level.

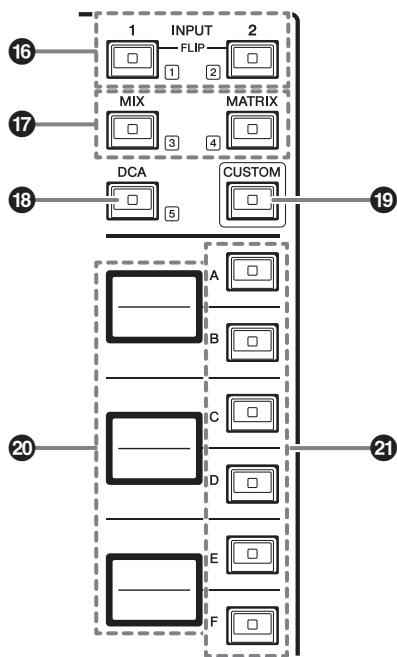

16 INPUT [1]/[2] keys

Enable you to select an input layer. Press the INPUT [1] key to select the INPUT 1-72 layer. Press the INPUT [2] key to select the INPUT 73-144 layer.

NOTE

Press the INPUT [1] key and INPUT [2] key simultaneously to select the INPUT 145-288 layer. Press these two keys simultaneously again to select the INPUT 1-144 layer. When the INPUT 145-288 layer is selected, these key indicators light up in a different color than when the INPUT 1-144 layer is selected.

17 [MIX]/[MATRIX] keys

Enable you to select an output layer.

18 [DCA] key

Enables you to select a DCA bank.

19 [CUSTOM] key

Turns Custom mode on or off.

Use the INPUT [1], [2], [MIX], [MATRIX], and [DCA] keys to select a Custom bank. The bank numbers (1-5) are labeled adjacent to these keys.

20 Layer displays

Indicates the name of the layer selected via the Layer select keys (see 21 on page 19).

21 Layer select [A]/[B]/[C]/[D]/[E]/[F] keys

Enable you to select a layer. Different layers are recalled to the faders depending on the combination of the keys, as shown in the table below:

(* Please refer to the Note regarding the 16 INPUT [1]/[2] keys.)

Key	INPUT [1] / INPUT [1]+[2]*	INPUT [2] / INPUT [1]+[2]*	[MIX]	[MATRIX]	[DCA]
[A]	Input 1-12 / 145-156*	Input 73-84 / 217-228*	MIX 1-12	MATRIX 1-12	DCA 1-12
[B]	Input 13-24 / 157-168*	Input 85-96 / 229-240*	MIX 13-24	MATRIX 13-24	DCA 13-24
[C]	Input 25-36 / 169-180*	Input 97-108 / 241-252*	MIX 25-36	MATRIX 25-36	—
[D]	Input 37-48 / 181-192*	Input 109-120 / 253-264*	MIX 37-48	STEREO	—
[E]	Input 49-60 / 193-204*	Input 121-132 / 265-276*	MIX 49-60	CUE/MONITOR	—
[F]	Input 61-72 / 205-216*	Input 133-144 / 277-288*	MIX 61-72	—	—

Front panel

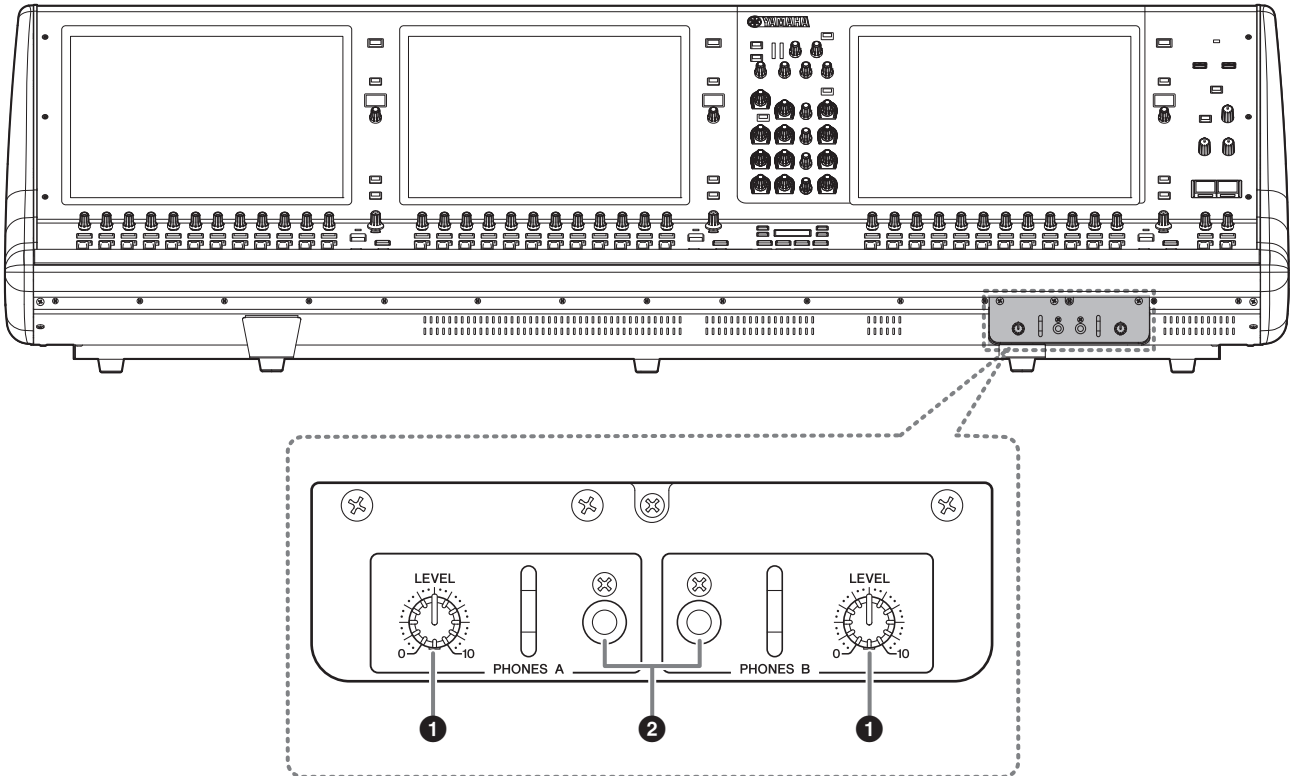

1 PHONES A/B [LEVEL] knobs

Adjust the level of the signal output from the PHONES output jacks respectively.

2 PHONES A/B output jacks

These are headphone jacks for monitoring the MONITOR or CUE signal.

Rear panel

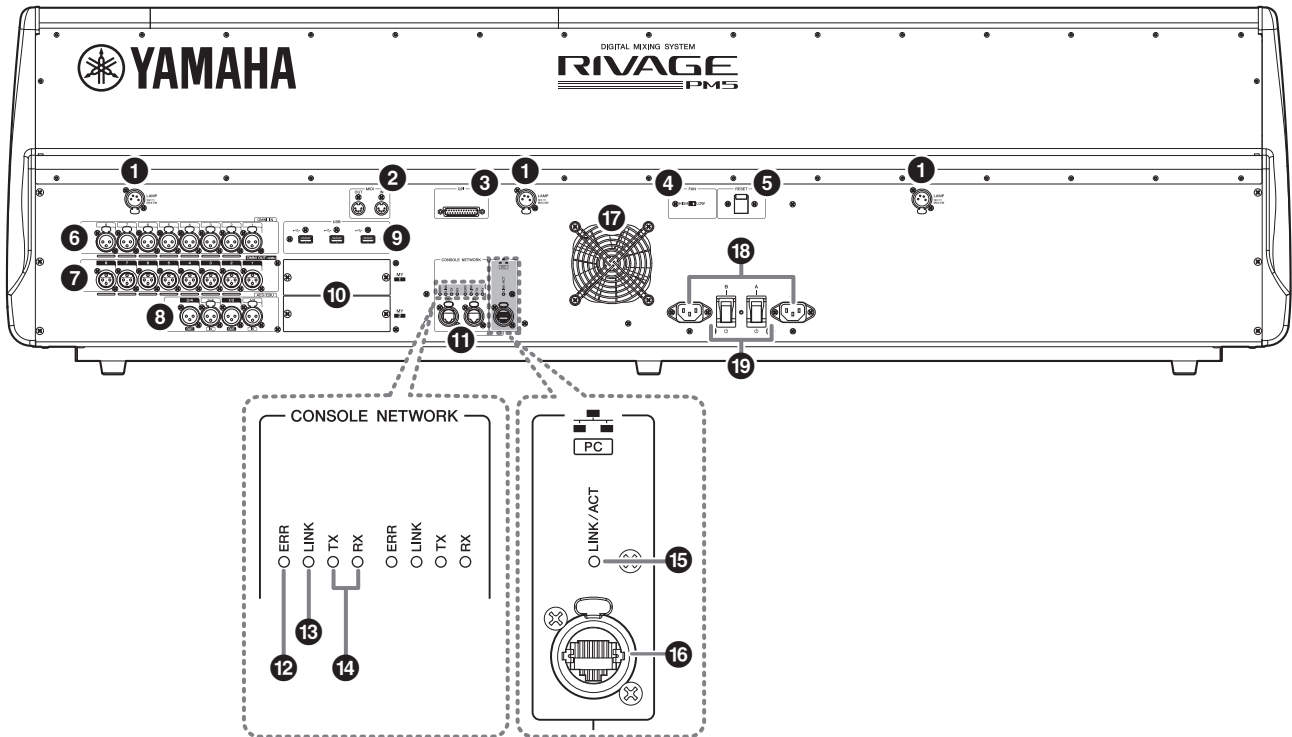

1 LAMP jacks

These four 4-pin female XLR output jacks are used to supply power to optional Yamaha LA1L gooseneck lamps.

2 MIDI OUT/IN jacks

These jacks are used to transmit/receive MIDI messages to/from external MIDI devices.

3 GPI connector

This is a D-sub 25-pin female connector that allows communication (8-in, 8-out) with a GPI-equipped external device.

4 [FAN] switch

Sets the internal cooling fan to operate at either HIGH or LOW speed.

NOTE

This switch is set to LOW when the unit is initially shipped from the factory. As long as the unit is operated within the specified ambient temperature range either the LOW or HIGH setting can be used. The HIGH setting is recommended if the ambient temperature is high, if the unit is in direct sunlight even if the ambient temperature is within the specified operating range, and in any situation in which fan noise is not a problem.

5 [RESET] switch

Resets the control surface.

Only the controls (screens, indicators, and control keys and knobs) on the control surface will restart without interrupting audio. Use this switch in case the control surface becomes non-responsive to your operations.

6 OMNI IN jacks

These are balanced XLR-3-31 female input jacks for inputting analog audio signals from line level devices or microphones.

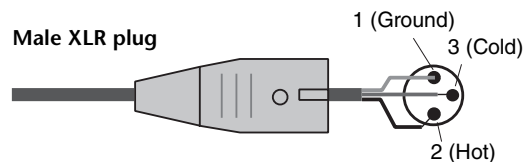

7 OMNI OUT jacks

These are balanced XLR-3-32 male output jacks that transmit analog audio signals.

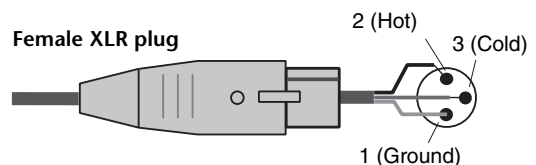

8 AES/EBU jacks

Both input and output jacks feature built-in sampling rate converters.

IN

These are balanced XLR-3-31 female input jacks that accept digital audio signals in AES/EBU format.

OUT

These are balanced XLR-3-32 male output jacks for outputting digital audio signals in the AES/EBU format.

9 USB ports

Use these ports to connect a USB storage device such as a flash drive, USB mouse, or USB keyboard.

10 MY card slots

Install optional Mini-YGDAI I/O cards here to expand I/O ports.

11 CONSOLE NETWORK OUT/IN connectors

These RJ-45 connectors allow the unit to be connected to a Console Network(*) in a ring topology via Ethernet cables (CAT5e or higher recommended).

* Console Network

A DSP engine is equipped with a special control surface terminal to connect to a control surface. A network created by the control surface and a DSP engine is called a "Console Network."

NOTE

- Use an STP (Shielded Twisted Pair) cable to prevent electromagnetic interference. Make sure that the metal parts of the plugs are electrically connected to the STP cable's shield by conductive tape or comparable means.
- The use of Ethernet cables with Neutrik etherCON CAT5 compatible RJ-45 plugs is recommended. Standard RJ45 plugs can also be used.
- Cable length can span up to 100 meters between devices. Maximum practical distance may vary depending on the cable used.

12 ERR indicators

This indicator lights up or flashes red if an error occurs.

In such an event, please contact your Yamaha dealer.

13 LINK indicators

This indicator flashes or lights up, depending on the network status.

Green (flashing)	<p>The unit is preparing to connect to the console network. If it continues flashing, the system is not functioning properly. If the problem persists after you take the following actions, please contact your Yamaha dealer.</p> <ul style="list-style-type: none"> • Make sure that the cables are connected properly. • Make sure that the cables are securely inserted (locked in). • Turn the power to the RIVAGE PM5 system off and then on. • Change to a different cable.
Green (lit steadily)	<p>The unit is connected to the console network properly.</p>

14 TX/RX indicators

The appropriate indicator flashes green when data is transmitted from (TX) or received at (RX) the TO ENGINE OUT/IN connectors.

15 LINK/ACT indicator

This indicator flashes or lights up green, depending on the connection status.

16 NETWORK [PC] connector

This RJ-45 connector allows the unit to be connected to a computer or network device via an Ethernet cable (CAT5e or higher recommended).

NOTE

- Use an STP (Shielded Twisted Pair) cable to prevent electromagnetic interference. Make sure that the metal parts of the plugs are electrically connected to the STP cable's shield by conductive tape or comparable means.
- The use of Ethernet cables with Neutrik etherCON CAT5 compatible RJ-45 plugs is recommended. Standard RJ45 plugs can also be used.
- Cable length can span up to 100 meters between devices. Maximum practical distance may vary depending on the cable used.

17 Vent

The control surface is equipped with cooling fans. These vents let warm air out from the unit. Please make sure that you do not block the vents with any object. The air intake is located on the bottom of the front panel.



Caution

Do not block the vents. This product has ventilation holes at the rear/under the front to prevent the internal temperature from becoming too high. Inadequate ventilation can result in overheating, possibly causing damage to the product(s), or even fire.

18 AC IN connectors

Use these sockets to connect the supplied power cords. First connect the AC power cords to this unit, and then insert the power cord plugs into AC outlets. Insert the cable plugs all the way until they lock in place securely. The supplied AC power cords feature a V-lock mechanism via a latch, which prevents the power cords from disconnecting accidentally.



Caution

Be sure to turn off the power to the unit before connecting or disconnecting the power cords.

To disconnect each power cord, remove it while pressing the latch on the plug.

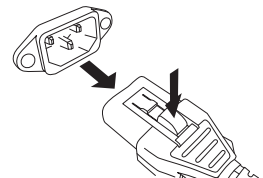

19 [I]/[O] (Power switches A/B)

Toggle between power on (I) and off (O).

While the power is turned on, the POWER indicator (see 1 on page 13) on the top panel will light up.

Power Supply / Shutdown

Connecting to power sources

1. Turn off both power switches A and B on the unit.
2. Connect one of the supplied power cords to AC IN connector (A), and the other to AC IN connector (B).
3. Connect the other end of each power cord to an AC outlet of a different power source.

NOTE

- Follow this procedure in reverse order when disconnecting the power cords.
- To disconnect each power cord, remove it while pressing the latch on the plug.



Warning

Use only the supplied AC power cords. Using other cords may lead to overheating or electric shock.



Caution

Be sure to turn off the power to the unit before connecting or disconnecting the power cords.

Shutting down the power to the unit

Before you turn off the power to the control surface, Yamaha recommends that you store the current status to scene memory.

If you change the connection status of the components after the power is turned off, some settings, such as patching, may be altered when you turn the power on again. For more information on storing a scene, please refer to the RIVAGE PM series Operation Manual.

NOTICE

If you turn off the power to the control surface without following the shutdown procedure, data inside the built-in storage may be damaged. Be sure to perform the shutdown procedure to turn off the power to the control surface.

1. Press the [SYSTEM] key (see ④ on page 13) for two seconds or longer.

A message will ask you to confirm the shutdown operation.



2. To turn the power off, press the OK button. To cancel shutdown, press the CANCEL button.
3. Wait until the LEDs on the panel turn off and the touch screens go dark.
4. Turn off both power switches A and B on the rear panel.

NOTICE

- If you plan to turn on the power to the control surface again, wait at least five seconds before switching the power on. Otherwise, the unit may malfunction.
- Even when the power switches are turned off, a small amount of current still flows through the unit. If you plan not to use the unit for a long period of time, remove the power cords from the AC outlets.

Installing and Removing Optional Cards

Installing a Mini-YGDAI card

Before you install the card, you must check the Yamaha Pro Audio global website to see whether your CS-R5 supports that card, and to verify the number of other Yamaha cards or third-party cards that can be used in conjunction with this card.

<http://www.yamahaproaudio.com/>

1. Make sure that the power is turned off.



Caution

Installing or removing a card while the power is on may lead to component failure or electric shock.

2. Loosen the screws that fasten the slot cover, and remove the slot cover.

Keep the cover and fixing screws in a safe place for future use.

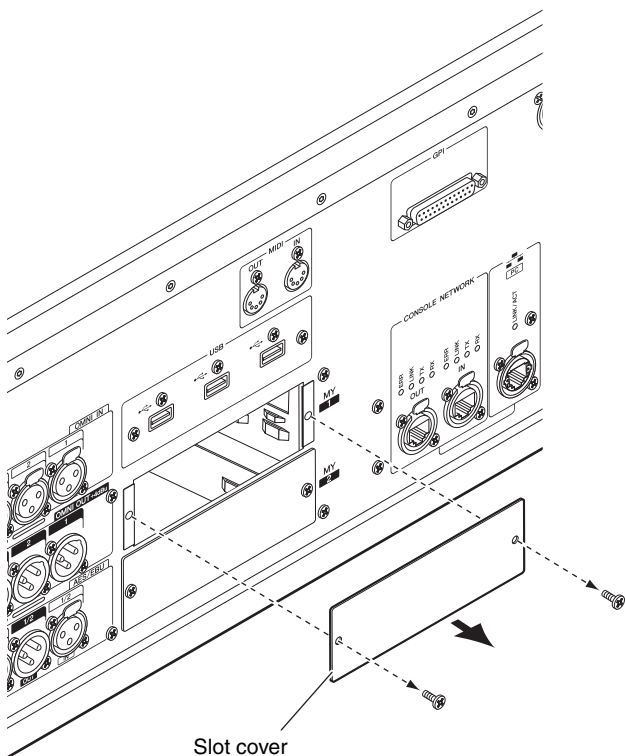

3. Align both edges of the card with the guide rails inside the slot, and then insert the card into the slot.

Push the card all the way into the slot so that the connector at the end of the card is correctly inserted into the connector inside the slot.

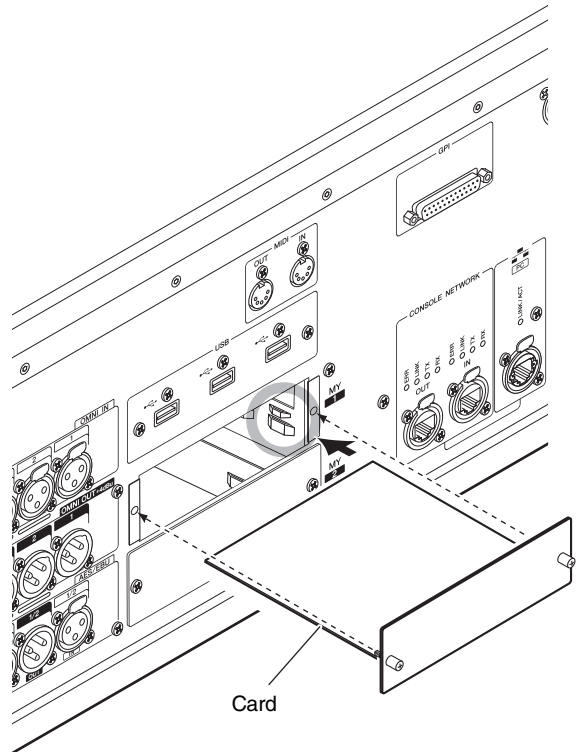

4. Fasten the card using the screws attached to the card.

If the card is not fastened securely, component failure or malfunction may occur.

Removing the Mini-YGDAI card

1. Make sure that the power is turned off.



Caution

Installing or removing a card while the power is on may lead to component failure or electric shock.

2. Completely loosen the screws that hold the card in place.
3. Pull the card toward you while holding the screws on the card.
4. Replace the stored slot cover and affix it with the screws.

Touch Screen

Basic touch screen operations

This section explains the basic procedures you can perform on the unit's touch screens.

Pressing the touch screen

You will use this operation primarily to switch screens and pages, to select the parameter to be operated, and to turn a button on/off. Some buttons enable you to change the value depending on the location you press.

On-screen user interface

This section explains various user interface components shown in the touch screens, and how to use them.

Tabs

Tabs enable you to switch between multiple pages. Each tab indicates its page name.

Buttons

Buttons are used to execute specific functions, to switch parameters on or off, or to select one of multiple choices. Buttons that perform on/off operations appear in solid background colors while they are turned on, and dark while turned off.

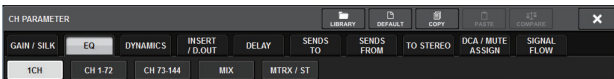

Faders/knobs

Faders and knobs on screen move in tandem when you operate the top panel faders and knobs. The current value appears immediately below the fader or knob.

If you press once a knob that can be operated by the [TOUCH AND TURN] knob, a thick frame appears around the knob. This frame indicates that the knob has been selected for operation.

NOTE

Pressing certain knobs a second time while a thick frame is displayed around them will open a window in which you can make additional detailed settings.

List windows

Windows similar to the following enable you to select items from a list, such as a list of USER DEFINED keys.

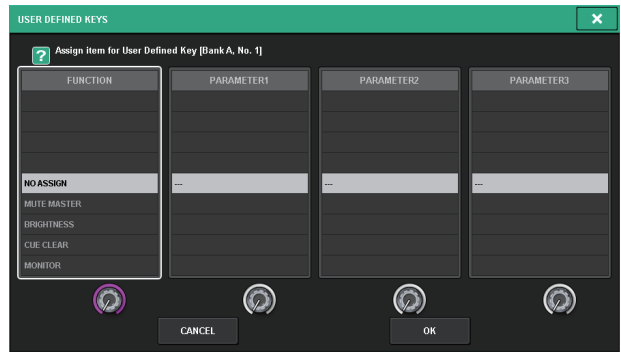

The highlighted item in the middle of the list is the item that is selected for operation. Press the screen encoders located below the list to scroll the list upward or downward.

Keyboard window

The following keyboard window will appear when you need to assign a name or comment to a scene or library, or when you need to assign a channel name. Press characters in the window to enter the desired characters.



Popup windows

When you press a button or field for a specific parameter in a screen, a window showing details or a list for that parameter will appear. These are called “popup windows.”



You can switch between popup windows using tabs as needed. Some popup windows show several buttons called “tool buttons” at the top of the window. You can use these tool buttons to recall libraries or to perform copy and paste operations.

Press the “X” symbol located in the upper right corner to close the popup window and return to the previous screen.

Dialog boxes

A dialog box like the following will appear when you need to confirm the operation you just performed.

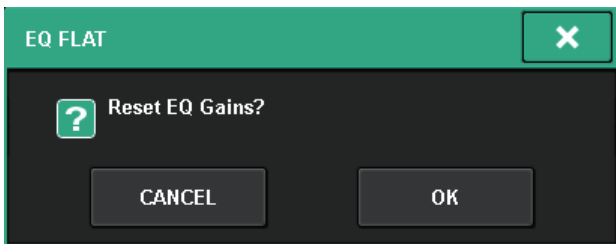

Press the OK button to execute the operation. The operation will be canceled if you press the CANCEL button.

Viewing a touch screen

The following examples describe two types of screens displayed on the touch screens.

OVERVIEW screen

This screen shows the main parameters of 12 channels selected as a layer.



SELECTED CHANNEL VIEW screen

This screen shows all mix parameters of the currently-selected channel.



Other Operations

Initializing the unit to factory default settings

If an error occurs in the unit's internal memory, or if you forget the password and cannot operate the unit, you can use the following procedure to initialize the internal memory.

NOTICE

When you initialize the internal memory, all content that had been saved in memory will be lost.

Use caution when performing the following steps.

1. Press the **SETUP** button on the menu bar in the touch screen.



The **SETUP** screen will appear.

2. Press the **MAINTENANCE** button.



The **MAINTENANCE** popup window will appear. This window includes several pages, which you can switch between using the tabs located at the top of the window.



3. Press the **INITIALIZATION** tab.
4. You can select multiple items to be initialized as required by the desired initialization method.
 - SYSTEM LOG
 - LIBRARY
 - SCENE
 - OTHER
5. Press the **INITIALIZE THIS CONSOLE** button. A dialog box will ask you to confirm the operation.
6. Press the **OK** button in the confirmation dialog box.

The Initialization operation starts.

NOTE

The control surface will restart after initialization.

Adjusting the faders (Calibration function)

Depending on the environment in which you use the system, discrepancies may occur in the motion of the motorized faders. You can use the Calibration function to correct these discrepancies. The RIVAGE PM5 system features two types of fader calibration.

MOTOR DRIVE Calibration	Automatically optimizes the motorized fader movement.
POSITIONING Calibration	Calibrates the motorized fader movement so that the fader knob positions and the level values stored in the console (parameter) will match.

NOTE

An alarm message will appear if a problem is detected in the fader settings while the RIVAGE PM5 system is starting up.

1. Press the **SETUP** button on the menu bar in the touch screen.



The **SETUP** screen will appear.

2. Press the **MAINTENANCE** button.



The **MAINTENANCE** popup window will appear. This window includes several pages, which you can switch between using the tabs located at the top of the window.

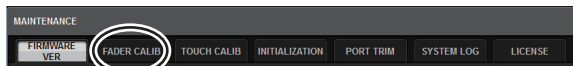

3. Press the **FADER CALIB** tab.

The **FADER CALIBRATION** screen will appear, which will enable you to adjust the faders.

4. Select the tab for the desired fader calibration operation.



If MOTOR DRIVE is selected:

For the specified faders in the Channel Strip section and Master section, the motorized fader movement will be automatically calibrated.

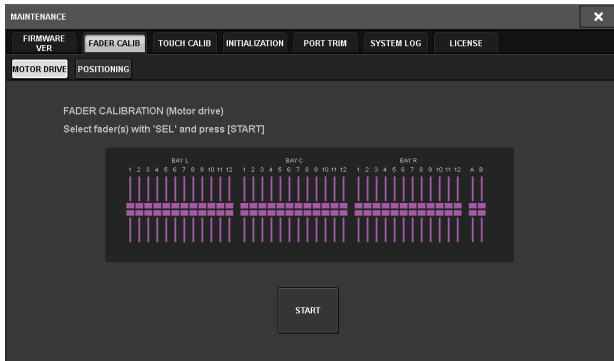

5. Press the [SEL] key for each fader that you want to calibrate.

Faders for which a problem was detected in the fader settings at start-up will already be selected.

6. Press the START button.

The system starts optimizing the movement of the motorized faders. The corresponding [SEL] keys will flash during calibration.

To cancel in the middle of calibration, press the STOP button. When optimization of the motorized fader movement is complete, the [SEL] keys will go dark.

7. When calibration has been completed, press the FINISH button.

The calibration values will be saved in internal memory. If the [SEL] key lights and the channel color indicator becomes red, calibration has failed. Press the START button to perform calibration again.

If POSITIONING is selected:

For the specified faders in the Channel Strip section and Master section, the fader position will be calibrated.

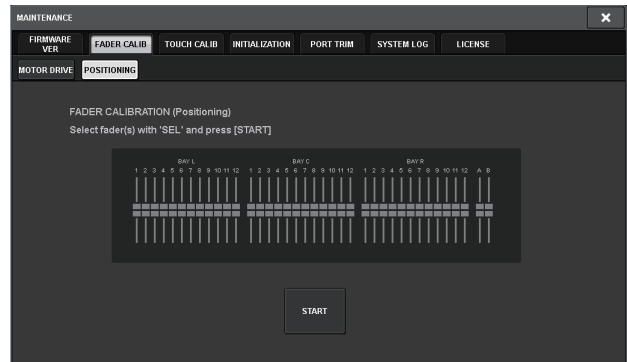

5. Press the [SEL] key for each fader that you want to calibrate.

Faders for which a problem was detected in the fader settings at start-up will already be selected.

6. Press the START button.

7. Each of the specified faders will move to the target positions in the following sequence.

Manually move the faders to the correct positions.

- (1) $-\infty$ dB (all the way down)
- (2) -20 dB
- (3) 0 dB
- (4) +10 dB (all the way up)

8. After you adjust the fader position, press the NEXT button.

The process will proceed to the next fader position.

9. Repeat steps 7 and 8 to adjust the faders for positions (1) through (4).

10. When calibration is complete, press the FINISH button.

The calibration values will be saved in internal memory. If the [SEL] key lights and the channel color indicator turns red, calibration has failed. Press the START button to perform calibration again.

Troubleshooting

Please visit the Yamaha Pro Audio global website for a list of frequently asked questions (FAQ).

<http://www.yamahaproaudio.com/>

Power does not turn on.

- Make sure that the power switches are turned ON.
- Make sure that the AC power cords are connected.
- ➔ If the power still does not turn on, contact your Yamaha dealer.

The unit is not receiving an audio input signal.

- If you are using an optional card, make sure that it is installed properly.
- Make sure that the cables are connected properly.
- Make sure that the [ON] key indicator of the input channel lights steadily.
- Make sure that the fader of the input channel is raised.

Sound is not loud enough.

- Make sure that the head amp gain is set to an appropriate level.
- Make sure that the digital gain is set to an appropriate level.
- Make sure that the fader of the input channel is raised.
- Make sure that the fader of the output channel is raised.

Sound is distorted.

- Make sure that the head amp is set correctly.
- Make sure that the fader of the input channel is not raised too high.
- Make sure that the fader of the output channel is not raised too high.

Touch screens, LEDs and/or lamps are not bright enough.

- The brightness parameter on the SETUP screen may be set too low.

In the LCD display, there are some dots that are always dark or always lit.

- This is a common property of color LCD, not a malfunction.

Specifications

General Specifications

Mixing capacity		288 Inputs, 72 MIX + 36 MATRIX + 2 STEREO (DSP-RX-EX)	
Sampling frequency	Internal clock	Frequency	44.1 kHz, 48 kHz, 88.2 kHz, 96 kHz
		Accuracy	±50 ppm
		Jitter ^{*1}	1.0 ns @Fs=88.2 kHz/96 kHz, 2.0 ns @Fs=44.1 kHz/48 kHz
User interface		100 mm touch-sensitive motorized fader (resolution=1024 steps) × 38 15" multi-touch screen (high brightness, wide view angle) × 3 Touch sensitive knobs in the Selected Channel section	
Power requirements		100-240 V, 50/60 Hz	
Power consumption		300 W	
Dimensions	W × H × D	1444 mm × 414 mm × 643 mm (including the rubber feet)	
Weight		42 kg	
NC value ^{*2}		FAN speed LOW: NC=15 / HIGH: NC=25	
Temperature range	Operating temperature range	Min: 0°C, Max: 40°C	
	Storage temperature range	Min: -20°C, Max: 60°C	
Accessories		Owner's Manual, AC power cord × 2, Dust cover, Nuendo Live (DAW software)	
Optional items		Mini-YGDAI card, Gooseneck Lamp LA1L	

*1. Measured at the AES/EBU OUT.

*2. Measured 30 cm horizontally away and vertically up from the unit (front pad).

Audio Specifications

At the time of measurement, all levels are set to nominal. Output impedance of the signal generator is 150Ω.

Frequency response

@20 Hz–20 kHz, reference to the nominal output level @1 kHz

Input	Output	RL	Conditions	Min.	Typ.	Max.	Unit
OMNI IN 1–8	OMNI OUT 1–8	600Ω	GAIN: +66 dB	-1.5	0.0	0.5	dB

Total harmonic distortion

Input	Output	RL	Conditions	Min.	Typ.	Max.	Unit
OMNI IN 1–8	OMNI OUT 1–8	600Ω	+4 dBu@20 Hz–20 kHz, GAIN: -6 dB			0.05	%
Internal OSC	OMNI OUT 1–8	600Ω	Full scale output @1 kHz			0.02	%
Internal OSC	PHONES	8Ω	Full scale output @1 kHz, PHONES A/B LEVEL: max.			0.2	%

* Total Harmonic Distortion is measured with an 18 dB/oct filter @80 kHz.

Hum & noise^{*2}

Input	Output	RL	Conditions	Min.	Typ.	Max.	Unit
OMNI IN 1–8	OMNI OUT 1–8	600Ω	Rs= 150Ω, GAIN: +66 dB		-128 EIN ^{*1}		dBu
					-62		dBu
OMNI IN 1–8	OMNI OUT 1–8	600Ω	Rs= 150Ω, GAIN: -6 dB		-91	-86	dBu
—	OMNI OUT 1–8	600Ω	Residual output noise, output channel is off.		-96		dBu
—	PHONES	8Ω	Residual output noise, PHONES A/B LEVEL: min.			-88	dBu

*1. EIN=Equivalent Input Noise

*2. Hum & noise is measured with an IHF-A filter.

Dynamic range

Input	Output	RL	Conditions	Min.	Typ.	Max.	Unit
OMNI IN 1-8	OMNI OUT 1-8	600Ω	AD + DA, GAIN: -6 dB		115		dB
—	OMNI OUT 1-8	600Ω	DA Converter		120		dB

* Dynamic range is measured with an IHF-A filter.

Crosstalk (@1kHz)

from/to	to/from	Conditions	Min.	Typ.	Max.	Unit
OMNI IN n	OMNI IN (n-1) or (n+1)	OMNI IN 1-8, adjacent inputs, GAIN: -6 dB			-100	dB
OMNI OUT n	OMNI OUT (n-1) or (n+1)	OMNI OUT 1-8, input to output			-100	dB

* Crosstalk is measured with a 30 dB/oct filter @22 kHz.

Input/output Characteristics

Analog input characteristics ^{*3*4}

Input Jack	Gain	Input Impedance	Source Impedance	Input Level			Connector
				Sensitivity* ¹	Rated Level	Max. Level Before Clipping	
OMNI IN 1-8	+66 dB	7.5 kΩ	50-600Ω Mics & 600Ω Lines	-82 dBu (61.6 μV)	-62 dBu (0.616 mV)	-42 dBu (6.16 mV)	XLR-3-31 type (Balanced) ^{*2}
	-6 dB			-10 dBu (245 mV)	+10 dBu (2.45 V)	+30 dBu (24.5 V)	

*1. Sensitivity is defined as the input level required to produce an output of +4 dBu (1.23 V) or the nominal output level when all faders and level controls are set to maximum.

*2. 1= GND, 2= HOT, 3= COLD

*3. 0 dBu= 0.775 Vrms

*4. OMNI IN 1-8 feature +48V DC phantom power, which is switchable for each jack individually.

Analog output characteristics ^{*5}

Output Jack	Output Impedance	Load Impedance	Max Output Level Select Switch* ¹	Output Level		Connector
				Rated Level	Max. Level Before Clipping	
OMNI OUT 1-8	75Ω	600Ω Lines	+24 dBu (default)	+4 dBu (1.23 V)	+24 dBu (12.3 V)	XLR-3-32 type (Balanced) ^{*2}
			+18 dBu	-2 dBu (0.616 V)	+18 dBu (6.16 V)	
PHONES A, B	15Ω	8Ω Phones	—	75 mW ^{*3}	150 mW	Stereo Phone Jack (TRS) (Unbalanced) ^{*4}
		40Ω Phones	—	65 mW ^{*3}	150 mW	

*1. The unit features an internal switch to change the maximum output level.

*2. 1=GND, 2=HOT, 3=COLD

*3. These measurements were obtained when the PHONES A/B LEVEL knobs were set 10 dB lower than the maximum.

*4. Tip=LEFT, Ring=RIGHT, Sleeve=GND

*5. 0 dBu= 0.775 Vrms

Digital I/O characteristics

Jack	Format	Data Length	Level	Audio	Connector
AES/EBU IN 1/2, 3/4 ^{*1}	AES/EBU	24 bit	RS422	2ch input	XLR-3-31 type (Balanced) ^{*2}
AES/EBU OUT 1/2, 3/4 ^{*1}	AES/EBU	24 bit	RS422	2ch output	XLR-3-32 type (Balanced) ^{*2}

*1. Features sampling rate converters.

Supported input/output frequency: 40-102 kHz

*2. 1=GND, 2=HOT, 3=COLD

I/O slot characteristics

MY card slot × 2

Control I/O characteristics

Terminal	Format	Level	Connector
MIDI IN	MIDI	–	DIN 5pin
MIDI OUT	MIDI	–	DIN 5pin
USB 1–4	USB 2.0 Host	USB	USB A (Female)
RECORDING* ¹	USB 2.0 Host	USB	USB A (Female)
NETWORK [PC]	IEEE802.3	10BASE-T/100BASE-TX	etherCON CAT5* ² * ⁴
CONSOLE NETWORK IN/OUT	–	1000BASE-T	etherCON CAT5e* ³ * ⁴
GPI* ⁵	–	–	D-sub 25 pin (Female)
LAMP 1–3	–	0–12 V	XLR-4-31 type* ⁶

*1. Supported file formats are WAV and MP3.

*2. CAT5 or higher cables are used for connections.

*3. CAT5e or higher cables are used for connections.

*4. STP cables are recommended for connections.

*5. Input pin

CH 1-7: TTL (input voltage 0-5 V)

CH 8: Photo coupler (input voltage 0-24 V, low level 1 V or lower, high level 5 V or higher)

Output pin

CH 1-7: Open-drain (max. supply voltage 12 V, max. sink current/pin 75 mA)

CH 8: Relay contact (max. 1 A/30 VDC)

Power supply pin

5 V ±5%, max. output current 600 mA

*6. 3=GND, 4=+12 V; Up to 5 W is supported for lamp rating.

Pin Assignment Table

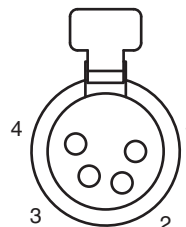
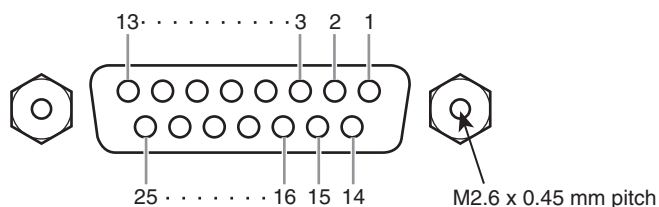

GPI

Pin No.	Signal	Pin No.	Signal
1	GPO1	14	GPO2
2	GPO3	15	GPO4
3	GPO5	16	GPO6
4	GPO7	17	RLY_NC
5	RLY_C	18	RLY_NO
6	GND	19	GND
7	GND	20	OPTO-
8	OPTO+	21	+5V
9	+5V	22	GPI1
10	GPI2	23	GPI3
11	GPI4	24	GPI5
12	GPI6	25	GPI7
13	N.C.		

LAMP

Pin No.	Signal
1	N.C.
2	N.C.
3	GND
4	+12V

Dimensional Diagrams

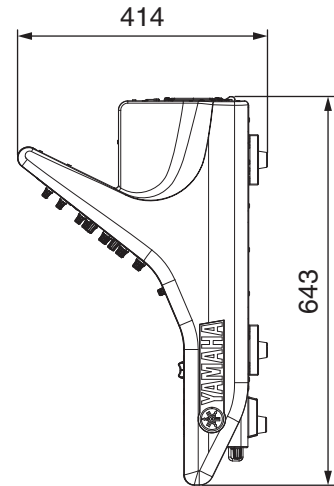
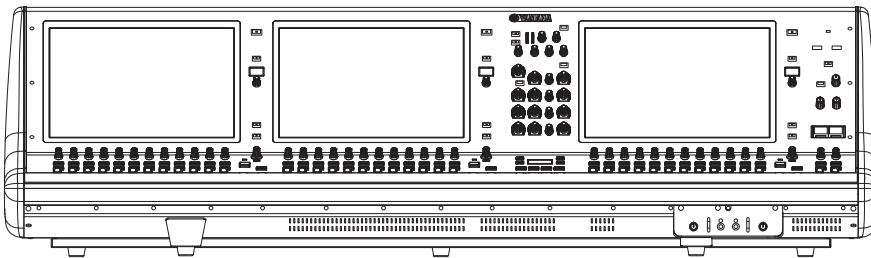
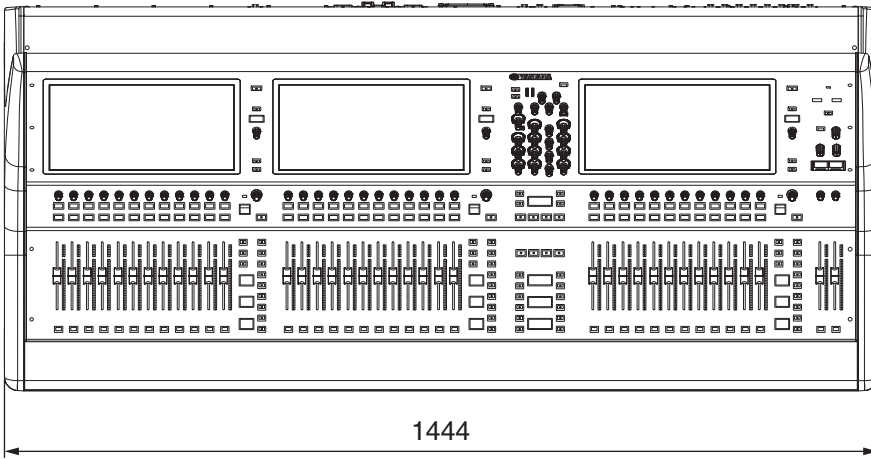
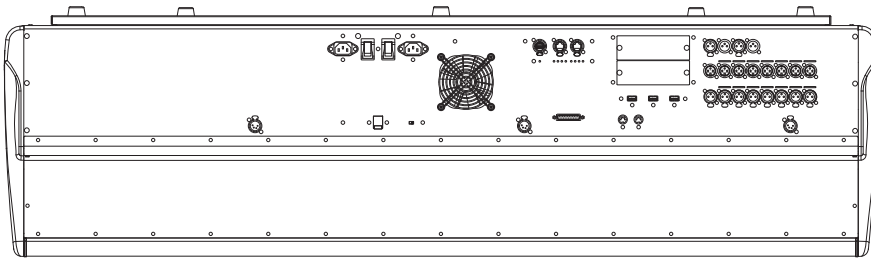

Unit: mm

Approximate Munsell value of exterior color: N5

* The contents of this manual apply to the latest specifications as of the publishing date. To obtain the latest manual, access the Yamaha website then download the manual file.

Index

A

ASSIGN 16

C

Calibration 27

Channel encoder 18

CUE 18

CUSTOM 19

D

DCA 19

E

ENCODER ASSIGN 17

F

FAN 21

Front panel 20

H

HOME 17

I

Initializing 27

INPUT 19

M

MATRIX 19

MIX 19

O

Optional Cards

Mini-YGDAI card 24

OVERLAY 14

P

[I]/[⏻] (Power switches A/B) 22

R

Rear panel 21

RESET 21

S

Screen encoder 18

SEL 18

SEND / USER DEFINED KNOB 16

SENDS ON FADER 17

SHIFT 17

Shutting down 23

T

Top panel

Channel Strip section 17

SCENE MEMORY section 14

Selected Channel section 11

Touch Screen section 16

USER DEFINED KEYS section 15

UTILITY section 13

TOUCH AND TURN 17

Touch Screen 25

V

VIEW 16

ADDRESS LIST

NORTH AMERICA

CANADA

Yamaha Canada Music Ltd.
135 Milner Avenue, Toronto, Ontario,
M1S 3R1, Canada
Tel: +1-416-298-1311

U.S.A.

Yamaha Corporation of America
6600 Orangethorpe Avenue, Buena Park, CA 90620,
U.S.A.
Tel: +1-714-522-9011

CENTRAL & SOUTH AMERICA

MEXICO

Yamaha de México, S.A. de C.V.
Av. Insurgentes Sur 1647 Piso 9, Col. San José
Insurgentes, Delegación Benito Juárez, México,
D.F., C.P. 03900, México
Tel: +52-55-5804-0600

BRAZIL

Yamaha Musical do Brasil Ltda.
Praça Professor José Lannes, 40, Cjs 21 e 22, Brooklin
Paulista Novo CEP 04571-100 – São Paulo – SP,
Brazil
Tel: +55-11-3704-1377

ARGENTINA

**Yamaha Music Latin America, S.A.,
Sucursal Argentina**
Olga Cossettini 1553, Piso 4 Norte,
Madero Este-C1107CEK,
Buenos Aires, Argentina
Tel: +54-11-4119-7000

PANAMA AND OTHER LATIN

AMERICAN/CARIBBEAN REGIONS

Yamaha Music Latin America, S.A.
Edif. Torre Banco General, Piso 7, Urbanización
Marbella, Calle 47 y Aquilino de la Guardia,
Ciudad de Panamá, República de Panamá
Tel: +507-269-5311

EUROPE

THE UNITED KINGDOM/IRELAND

Yamaha Music Europe GmbH (UK)
Sherbourne Drive, Tilbrook, Milton Keynes,
MK7 8BL, U.K.
Tel: +44-1908-366700

GERMANY

Yamaha Music Europe GmbH
Siemensstrasse 22-34, 25462 Rellingen, Germany
Tel: +49-4101-303-0

SWITZERLAND/LIECHTENSTEIN

**Yamaha Music Europe GmbH, Branch
Switzerland in Thalwil**
Seestrasse 18a, 8800 Thalwil, Switzerland
Tel: +41-44-3878080

AUSTRIA/BULGARIA/ CZECH REPUBLIC/HUNGARY/ ROMANIA/SLOVAKIA/SLOVENIA

**Yamaha Music Europe GmbH
Branch Austria**
Schleiergasse 20, 1100 Wien, Austria
Tel: +43-1-60203900

POLAND

Yamaha Music Europe GmbH
Sp.z o.o. Oddział w Polsce
ul. Wielicka 52, 02-657 Warszawa, Poland
Tel: +48-22-880-08-88

MALTA

Olimpus Music Ltd.
Valletta Road, Mosta MST9010, Malta
Tel: +356-2133-2093

NETHERLANDS/BELGIUM/ LUXEMBOURG

Yamaha Music Europe Branch Benelux
Clarissenhof 5b, 4133 AB Vianen, The Netherlands
Tel: +31-347-358040

FRANCE

Yamaha Music Europe
7 rue Ambroise Croizat, Zone d'activités de Pariest,
77183 Croissy-Beaubourg, France
Tel: +33-1-6461-4000

ITALY

Yamaha Music Europe GmbH, Branch Italy
Via Tinelli N.67/69 20855 Gerno di Lesmo (MB),
Italy
Tel: +39-039-9065-1

SPAIN/PORTUGAL

**Yamaha Music Europe GmbH Ibérica, Sucursal
en España**
Ctra. de la Coruña km. 17,200, 28231
Las Rozas de Madrid, Spain
Tel: +34-91-639-88-88

GREECE

Philippos Nakas S.A. The Music House
19th klm. Leof. Lavriou 190 02 Peania – Attiki,
Greece
Tel: +30-210-6686168

SWEDEN/FINLAND/ICELAND

**Yamaha Music Europe GmbH Germany filial
Scandinavia**
JA Wettergrensgata 1, 400 43 Göteborg, Sweden
Tel: +46-31-89-34-00

DENMARK

**Yamaha Music Denmark,
Fillial of Yamaha Music Europe GmbH, Tyskland**
Generatorvej 8C, ST. TH., 2860 Søborg, Denmark
Tel: +45-44-92-49-00

NORWAY

**Yamaha Music Europe GmbH Germany -
Norwegian Branch**
Grini Næringspark 1, 1332 Østerås, Norway
Tel: +47-6716-7800

CYPRUS

Yamaha Music Europe GmbH
Siemensstrasse 22-34, 25462 Rellingen, Germany
Tel: +49-4101-303-0

RUSSIA

Yamaha Music (Russia) LLC.
Room 37, entrance 7, bld. 7, Kievskaya street,
Moscow, 121059, Russia
Tel: +7-495-626-5005

OTHER EUROPEAN REGIONS

Yamaha Music Europe GmbH
Siemensstrasse 22-34, 25462 Rellingen, Germany
Tel: +49-4101-3030

AFRICA

Yamaha Music Gulf FZE
JAFZA-16, Office 512, P.O.Box 17328,
Jebel Ali FZE, Dubai, UAE
Tel: +971-4-801-1500

MIDDLE EAST

TURKEY

Yamaha Music Europe GmbH
Merkezi Almanya Türkiye İstanbul Şubesi
Mor Sumbul Sokak Varyap Meridian Business
1.Blok No:1 113-114-115
Bati Atasehir Istanbul, Turkey
Tel: +90-216-275-7960

OTHER REGIONS

Yamaha Music Gulf FZE
JAFZA-16, Office 512, P.O.Box 17328,
Jebel Ali FZE, Dubai, UAE
Tel: +971-4-801-1500

ASIA

THE PEOPLE'S REPUBLIC OF CHINA

Yamaha Music & Electronics (China) Co.,Ltd.
2F, Yunhedasha, 1818 Xinzha-lu, Jingan-qu,
Shanghai, China
Tel: +86-400-051-7700

INDIA

Yamaha Music India Private Limited
P-401, JMD Megapolis, Sector-48, Sohna Road,
Gurugram-122018, Haryana, India
Tel: +91-124-485-3300

INDONESIA

PT. Yamaha Musik Indonesia (Distributor)
Yamaha Music Center Bldg. Jalan Jend. Gatot
Subroto Kav. 4, Jakarta 12930, Indonesia
Tel: +62-21-520-2577

KOREA

Yamaha Music Korea Ltd.
11F, Prudential Tower, 298, Gangnam-daero,
Gangnam-gu, Seoul, 06253, Korea
Tel: +82-2-3467-3300

MALAYSIA

Yamaha Music (Malaysia) Sdn. Bhd.
No.8, Jalan Perbandaran, Kelana Jaya, 47301
Petaling Jaya, Selangor, Malaysia
Tel: +60-3-78030900

SINGAPORE

Yamaha Music (Asia) Private Limited
Block 202 Hougang Street 21, #02-00,
Singapore 530202, Singapore
Tel: +65-6740-9200

TAIWAN

Yamaha Music & Electronics Taiwan Co.,Ltd.
2F., No.1, Yuandong Rd., Banqiao Dist.,
New Taipei City 22063, Taiwan (R.O.C.)
Tel: +886-2-7741-8888

THAILAND

Siam Music Yamaha Co., Ltd.
3, 4, 15, 16th FL., Siam Motors Building,
891/1 Rama 1 Road, Wangmai,
Pathumwan, Bangkok 10330, Thailand
Tel: +66-2215-2622

VIETNAM

Yamaha Music Vietnam Company Limited
15th Floor, Nam A Bank Tower, 201-203 Cach
Mang Thang Tam St., Ward 4, Dist.3,
Ho Chi Minh City, Vietnam
Tel: +84-8-3818-1122

OTHER ASIAN REGIONS

<http://asia.yamaha.com/>

OCEANIA

AUSTRALIA

Yamaha Music Australia Pty. Ltd.
Level 1, 80 Market Street, South Melbourne,
VIC 3205, Australia
Tel: +61-3-9693-5111

REGIONS AND TRUST TERRITORIES IN PACIFIC OCEAN

<http://asia.yamaha.com/>

Yamaha Pro Audio global website
<http://www.yamahaproaudio.com/>
Yamaha Downloads
<https://download.yamaha.com/>

Manual Development Group
© 2020 Yamaha Corporation
Published 03/2020
IPTO-A0

VCV0310