



U

YAS-70

(YAS-70CU + YAS-70SPX)

CENTER SYSTEM + SUBWOOFER/SYSTEM CONTROL

OWNER'S MANUAL

IMPORTANT SAFETY INSTRUCTIONS

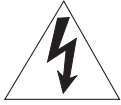

CAUTION
RISK OF ELECTRIC SHOCK
DO NOT OPEN



CAUTION: TO REDUCE THE RISK OF ELECTRIC SHOCK, DO NOT REMOVE COVER (OR BACK). NO USER-SERVICEABLE PARTS INSIDE. REFER SERVICING TO QUALIFIED SERVICE PERSONNEL.

• Explanation of Graphical Symbols



The lightning flash with arrowhead symbol, within an equilateral triangle, is intended to alert you to the presence of uninsulated “dangerous voltage” within the product’s enclosure that may be of sufficient magnitude to constitute a risk of electric shock to persons.



The exclamation point within an equilateral triangle is intended to alert you to the presence of important operating and maintenance (servicing) instructions in the literature accompanying the appliance.

Note to CATV system installer:

This reminder is provided to call the CATV system installer’s attention to Article 820-40 of the NEC that provides guidelines for proper grounding and, in particular, specifies that the cable ground shall be connected to the grounding system of the building, as close to the point of cable entry as practical.

- 1 Read these instructions.
- 2 Keep these instructions.
- 3 Heed all warnings.
- 4 Follow all instructions.
- 5 Do not use this apparatus near water.
- 6 Clean only with dry cloth.
- 7 Do not block any ventilation openings. Install in accordance with the manufacturer’s instructions.
- 8 Do not install near any heat sources such as radiators, heat registers, stoves, or other apparatus (including amplifiers) that produce heat.
- 9 Do not defeat the safety purpose of the polarized or grounding-type plug. A polarized plug has two blades with one wider than the other. A grounding type plug has two blades and a third grounding prong. The wide blade or the third prong are provided for your safety. If the provided plug does not fit into your outlet, consult an electrician for replacement of the obsolete outlet.
- 10 Protect the power cord from being walked on or pinched particularly at plugs, convenience receptacles, and the point where they exit from the apparatus.
- 11 Only use attachments/accessories specified by the manufacturer.
- 12 Use only with the cart, stand, tripod, bracket, or table specified by the manufacturer, or sold with the apparatus. When a cart is used, use caution when moving the cart/apparatus combination to avoid injury from tip-over. 
- 13 Unplug this apparatus during lightning storms or when unused for long periods of time.
- 14 Refer all servicing to qualified service personnel. Servicing is required when the apparatus has been damaged in any way, such as power-supply cord or plug is damaged, liquid has been spilled or objects have fallen into the apparatus, the apparatus has been exposed to rain or moisture, does not operate normally, or has been dropped.

FCC INFORMATION (for US customers)

1 **IMPORTANT NOTICE: DO NOT MODIFY THIS UNIT!**

This product, when installed as indicated in the instructions contained in this manual, meets FCC requirements. Modifications not expressly approved by Yamaha may void your authority, granted by the FCC, to use the product.

2 IMPORTANT: When connecting this product to accessories and/or another product use only high quality shielded cables. Cable/s supplied with this product **MUST** be used. Follow all installation instructions. Failure to follow instructions could void your FCC authorization to use this product in the USA.

3 NOTE: This product has been tested and found to comply with the requirements listed in FCC Regulations, Part 15 for Class "B" digital devices. Compliance with these requirements provides a reasonable level of assurance that your use of this product in a residential environment will not result in harmful interference with other electronic devices.

This equipment generates/uses radio frequencies and, if not installed and used according to the instructions found in the users manual, may cause interference harmful to the operation of other electronic devices.

Compliance with FCC regulations does not guarantee that interference will not occur in all installations. If this product is found to be the source of interference, which can be determined by turning the unit "OFF" and "ON", please try to eliminate the problem by using one of the following measures:

Relocate either this product or the device that is being affected by the interference.

Utilize power outlets that are on different branch (circuit breaker or fuse) circuits or install AC line filter/s.

In the case of radio or TV interference, relocate/reorient the antenna. If the antenna lead-in is 300 ohm ribbon lead, change the lead-in to coaxial type cable.

If these corrective measures do not produce satisfactory results, please contact the local retailer authorized to distribute this type of product. If you can not locate the appropriate retailer, please contact Yamaha Electronics Corp., U.S.A. 6660 Orangethorpe Ave., Buena Park, CA 90620.

The above statements apply **ONLY** to those products distributed by Yamaha Corporation of America or its subsidiaries.

Caution: Read this before operating your unit.

- 1 To assure the finest performance, please read this manual carefully. Keep it in a safe place for future reference.
- 2 Install this sound system in a well ventilated, cool, dry, clean place – away from direct sunlight, heat sources, vibration, dust, moisture, and/or cold. Allow ventilation space of at least 30 cm on the top, 20 cm on the left and right, and 20 cm on the back of this unit.
- 3 Locate this unit away from other electrical appliances, motors, or transformers to avoid humming sounds.
- 4 Do not expose this unit to sudden temperature changes from cold to hot, and do not locate this unit in an environment with high humidity (i.e. a room with a humidifier) to prevent condensation inside this unit, which may cause an electrical shock, fire, damage to this unit, and/or personal injury.
- 5 Avoid installing this unit where foreign objects may fall onto this unit and/or this unit may be exposed to liquid dripping or splashing. On the top of this unit, do not place:
 - Other components, as they may cause damage and/or discoloration on the surface of this unit.
 - Burning objects (i.e. candles), as they may cause fire, damage to this unit, and/or personal injury.
 - Containers with liquid in them, as they may fall and liquid may cause electrical shock to the user and/or damage to this unit.
- 6 Do not cover this unit with a newspaper, tablecloth, curtain, etc. in order not to obstruct heat radiation. If the temperature inside this unit rises, it may cause fire, damage to this unit, and/or personal injury.
- 7 Do not plug in this unit to a wall outlet until all connections are complete.
- 8 Do not operate this unit upside-down. It may overheat, possibly causing damage.
- 9 Do not use force on switches, knobs and/or cords.
- 10 When disconnecting the power cable from the wall outlet, grasp the plug; do not pull the cable.
- 11 Do not clean this unit with chemical solvents; this might damage the finish. Use a clean, dry cloth.
- 12 Only voltage specified on this unit must be used. Using this unit with a higher voltage than specified is dangerous and may cause fire, damage to this unit, and/or personal injury. Yamaha will not be held responsible for any damage resulting from use of this unit with a voltage other than specified.
- 13 To prevent damage by lightning, keep the power cord and outdoor antennas disconnected from a wall outlet or the unit during a lightning storm.
- 14 Do not attempt to modify or fix this unit. Contact qualified Yamaha service personnel when any service is needed. The cabinet should never be opened for any reasons.
- 15 When not planning to use this unit for long periods of time (i.e. vacation), disconnect the AC power plug from the wall outlet.
- 16 Install this unit near the AC outlet and where the AC power plug can be reached easily.
- 17 Be sure to read the “Troubleshooting” section on common operating errors before concluding that this unit is faulty.
- 18 Before moving this unit, press STANDBY/ON to set this unit in standby mode, and disconnect the power supply cable from the wall outlet.
- 19 Condensation will form when the surrounding temperature changes suddenly. Disconnect the power supply cable from the outlet, then leave the unit alone.
- 20 The batteries shall not be exposed to excessive heat such as sunshine, fire or like.

WARNING

TO REDUCE THE RISK OF FIRE OR ELECTRIC SHOCK, DO NOT EXPOSE THIS UNIT TO RAIN OR MOISTURE.

This unit is not disconnected from the AC power source as long as it is connected to the AC wall outlet, even if this unit itself is turned off by STANDBY/ON. This state is called the standby mode. In this state, this unit is designed to consume a very small quantity of power.

FOR CANADIAN CUSTOMERS

To prevent electric shock, match wide blade of plug to wide slot and fully insert.

This Class B digital apparatus complies with Canadian ICES-003.

POUR LES CONSOMMATEURS CANADIENS

Pour éviter les chocs électriques, introduire la lame la plus large de la fiche dans la borne correspondante de la prise et pousser jusqu'au fond.

Cet appareil numérique de la classe B est conforme à la norme NMB-003 du Canada.

IMPORTANT

Please record the serial number of this unit in the space below.

MODEL:

Serial No.:

The serial number is located on the rear of the unit.

Retain this Owner's Manual in a safe place for future reference.

Contents

INTRODUCTION

Getting started	2
Supplied parts	2
Controls and functions.....	3

PREPARATION

Placing this system.....	7
Placing the center system.....	7
Connection.....	9
Connecting the center system and the subwoofer/system control.....	9
Connecting external components.....	10
Connecting a Yamaha iPod universal dock	12
Connecting the indoor FM antenna	12
Connecting the power cable.....	12

BASIC OPERATION

Basic playback operation	13
Enjoying various sound features.....	14
Enjoying realistic sounds (Sound field program)	14
Enjoying stereo sounds with multi speaker channels (Dolby Pro Logic II).....	15
Listening at low volume (Night listening mode).....	15
FM tuning.....	16
Overview.....	16
Controls and functions for the FM tuning	16
Basic tuning operation	17
Using station preset feature	18
Using iPod™.....	20
Controls and functions for iPod™.....	20
Useful operation.....	21
Changing the brightness of the front panel display	21
Turning off the front panel display.....	21

ADVANCED OPERATION

Adjusting the virtual speaker settings.....	22
Using the speaker test mode	23
Adjusting the characteristics of the tonal quality (ROOM EQ).....	25
Adjusting the speaker balance during playback	25

ADDITIONAL INFORMATION

Additional information	26
Troubleshooting.....	26
Glossary	28
Specifications.....	29

INTRODUCTION

PREPARATION

BASIC OPERATION

ADVANCED OPERATION

ADDITIONAL INFORMATION

English

■ Introduction

YAS-70 consists of the center system (YAS-70CU) and subwoofer/system control (YAS-70SPX). This product provides you with the best sound possible with simple operations, allowing you to enjoy various audio sources. We hope the “YAS-70” brings you great listening pleasure and satisfaction.

■ About this manual

- In this manual, operations that can be performed using either the front panel buttons or remote control are explained using the remote control.
-  indicates a tip for your operation. Notes contain important information about safety and operating instructions.
- This manual is printed prior to production. Design and specifications are subject to change in part as a result of improvements, etc. In case of differences between the manual and the product, the product has priority.

Getting started

Supplied parts

This product consists of the following parts. Before making connections, make sure you received all of the following parts.

■ Units

Center system (YAS-70CU) x 1

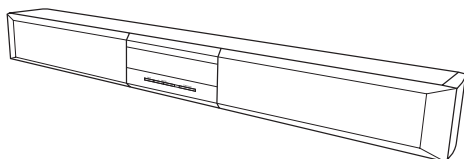

Subwoofer/system control (YAS-70SPX) x 1

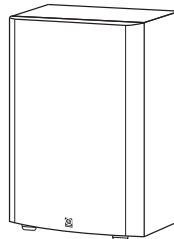

■ Accessories

System control cable (4 m) x 1



Speaker cable (4 m) x 2



Remote control x 1

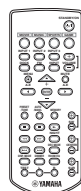

Indoor FM antenna x 1

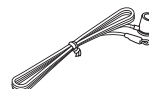

Spacer x 2

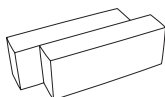

Battery x 2 (AAA, R03, UM4)

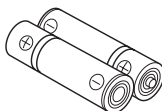

Mounting template x 1

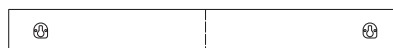

Double-sided tape (Small, 4 pieces) x 1



Double-sided tape (Large, 2 pieces) x 2



Owner's manual x 1



Note

The form of the supplied accessories varies depending on the models.

■ Front panel display of the center system

DSP indicators

CINEMA DSP indicator

Lights up when CINEMA DSP is activated.
([P. 14](#))

HiFi DSP indicator

Lights up when HiFi DSP is activated.
([P. 14](#))

DOCK indicator

Lights up when this unit recognizes iPod.
([P. 12](#))

NIGHT indicator

Lights up when you select a night listening mode. ([P. 15](#))

AUTO/TUNED/STEREO/MEMORY indicator

AUTO indicator

Shows that this system is in the automatic tuning mode. ([P. 17](#))

TUNED indicator

Lights up when this system is tuned into a radio station. ([P. 17](#))

STEREO indicator

Lights up when this system is receiving a strong signal from an FM stereo broadcast while the AUTO indicator is lit. ([P. 17](#))

MEMORY indicator

Flashes to show a station can be stored.
([P. 18](#))

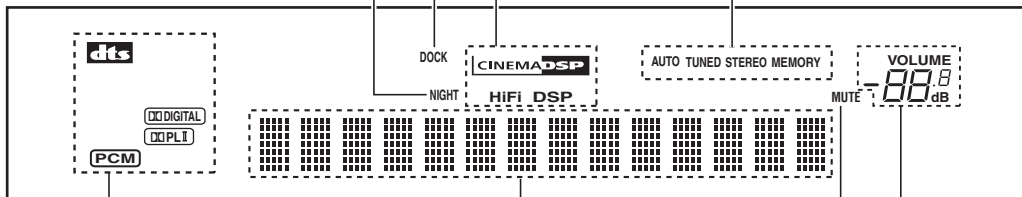

Multi information display

Shows the selected input source. When you are adjusting or changing setting, the name of the current sound field program and other information is displayed.

VOLUME

Indicates the current volume level.
([P. 13](#))

Decoder indicators

The respective indicator lights up when any of the decoders of this system functions.

MUTE indicator

Flashes while the mute function is activated.
([P. 13](#))

Remote control



Sound field program buttons

Select a sound field program.
([P. 14](#))

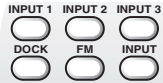

Input buttons

Select an input source you want to listen to.
([P. 13](#))

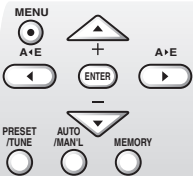

Control iPod and FM tuner.
([P. 16 and 20](#))



Control iPod.
([P. 20](#))



Adjust the brightness of the front panel display.
([P. 21](#))

Infrared signal transmitter

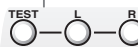
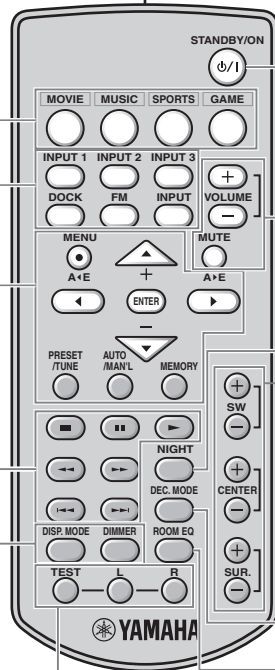

Adjust the virtual speaker balance.
([P. 23](#))



Turns on this system or sets it to the standby mode.
([P. 13](#))



Control the volume of this system.
([P. 13](#))



Turns on or off the night listening mode.
([P. 15](#))



Adjust the speaker balance.
([P. 25](#))



Selects a decoder mode (PL II Movie, PL II Music and Auto).
([P. 15](#))



Sets the room equalizer.
([P. 25](#))

■ Using the remote control

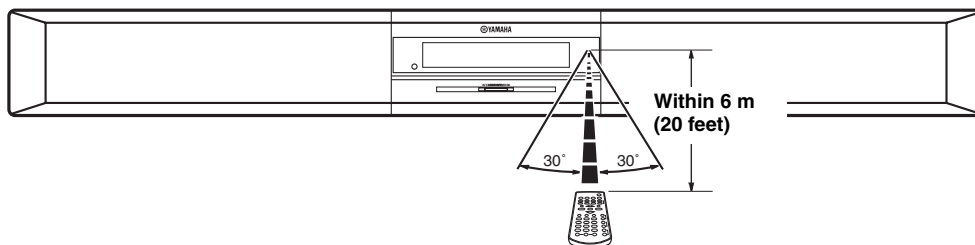

Use the remote control within 6 m (20 feet) of the center system and point it toward the remote control sensor.

Notes

- Be careful not to spill liquid on the remote control.
- Be careful not to drop the remote control.
- Do not leave the remote control in the following places:
 - hot or humid places, such as near a heater or in a bathroom
 - extremely cold places
 - dusty places

■ Installing the batteries

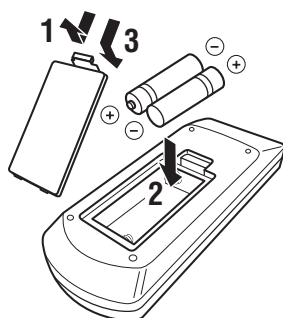

- 1** Take off the battery compartment cover.
- 2** Insert the 2 supplied batteries (AAA, R03, UM4) according to the polarity markings (+ and –) on the inside of the battery compartment.
- 3** Snap the battery compartment cover back into place.

Notes

- If the effective operation distance of the remote control decreases considerably, replace the batteries with two new ones as soon as possible.
- Do not use an old battery together with new one.
- Do not use different types of batteries (for example, alkaline and manganese) together. Each type of battery has its own characteristics even if they are similar in shape.
- If the batteries run out, immediately remove them from the remote control to prevent an explosion or acid leak.
- Dispose of the batteries according to the regional regulations.
- If a battery starts leaking, dispose of it immediately. Be careful not to let leaking battery acid come into contact with your skin or clothing. Before inserting new batteries, wipe the compartment clean.

Placing this system

To enjoy quality sounds thoroughly, you need to place this system in their appropriate positions and install them correctly. After deciding the layout, follow the procedure below to install this system.

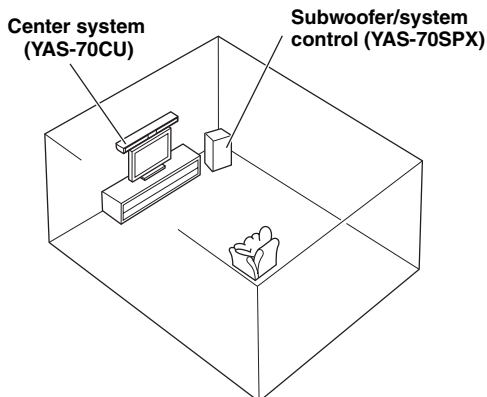

Center system (YAS-70CU)

Place the center system above a TV or beneath the TV so that the center system and your TV are aligned vertically. Make sure that the center system is placed in parallel with the wall.

Main roles: Produces front channel (stereo) sounds. Also produces center channel sounds (dialogues or vocal sounds) and surround channel sounds effectively using the Yamaha Air Surround system.

Subwoofer/system control (YAS-70SPX)

Place the subwoofer near the center system and turn it slightly toward the center of the room to reduce wall reflections.

Main roles: Produces bass sounds and low frequency (LFE) sounds contained in Dolby Digital or DTS sources.

Notes

- This system is shielded against magnetic rays. However, if the picture on your TV screen becomes blurred or distorted, we recommend moving this unit away from your TV.
- Bass sounds produced by the subwoofer/system control may be heard differently depending on the listening position and subwoofer location. To enjoy desired sounds, try changing the location of the subwoofer.
- Depending on your installation environment, connections with external components can be done before installing this system. We recommend that you temporarily place and arrange all components in order to decide which procedure must come first.

Placing the center system

You can place the center system on a rack or attach it to a wall. Select an installation method that suits your environment.

■ Placing the center system above/beneath a TV

Example 1: Above your TV

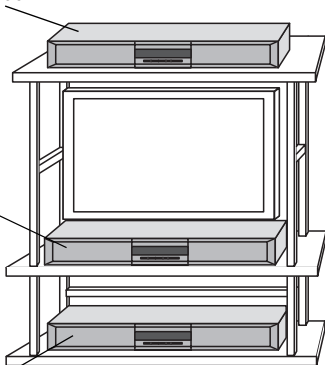

Example 2: Beneath your TV



Example 3: Under your TV



If there is any obstacle (TV stand etc.) under the center system, use the supplied spacers as follows.

- 1 Attach the supplied double-sided tapes on the spacers.

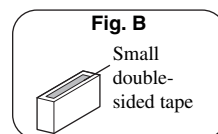
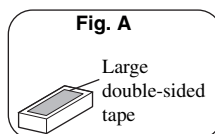

- 2 Attach the spacers to the bottom.

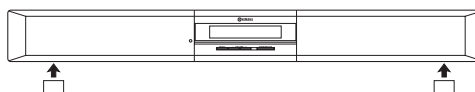

Notes

- Do not hide the remote control sensor of your TV etc. by the center system.
- The spacers may scratch or damage the surface of your rack or flooring. Be careful when placing or moving the center system.
- For your safety, take measures in advance to prevent the center system from falling.

■ Attaching the center system to a wall

You can attach the center system to a wall using commercially available screws (#8, Diameter: 7.5 mm or more (9/32" or more)).

When installing the center system on a wall, all installation work must be performed by a qualified contractor or dealer personnel. The customer must never attempt to perform this installation work. Improper or inadequate installation could cause the center system to fall, resulting in personal injury.

- 1 Attach the supplied mounting template on a wall and then mark the holes of the mounting template.**

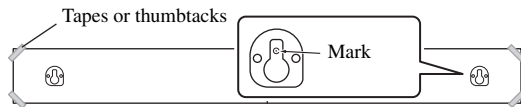

- 2 Remove the mounting template and then install the commercially available screws at the marks.**

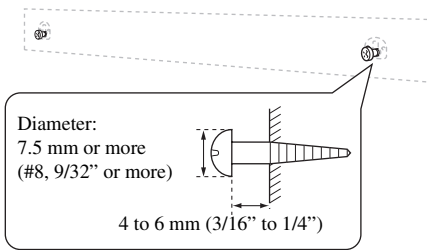

To install the cables above the center system, refer to the right column.

- 3 Hang the center system on the screws using the holes on the back of the center system.**

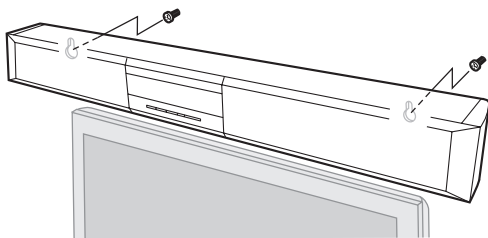

Notes

- The center system weighs about 4.5 kg (9 lbs. 15 oz.). To attach the center system to a wall using screws, the wall must be firm. Do not attach the center system to a wall that is made of weak materials such as plaster or veneered woods. Doing so may cause the center system to fall.
- Use commercially available screws that can endure weight enough.
- Make sure you use specified screws to attach the center system to a wall. Using clamps other than specified screws, such as short screws, nails, or two-sided tape, may cause the center system to fall.
- When connecting the center system, fix the speaker cables in place so that cables do not loosen. If your foot or hand accidentally gets caught on a loose speaker cable, the center system may fall.
- After attaching the center system, check that the center system is fixed securely. Yamaha will bear no responsibility for any accidents caused by improper installations.

Installing the cables above the center system

To pass the cables upward, you need to attach the spacers to make room on the back of the center system.

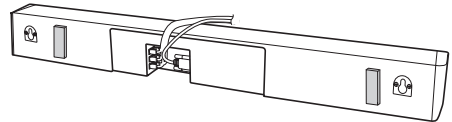

In step 2 of the left column;

- 2-a:** Attach the supplied spacers to the rear panel of the center system using the supplied double-sided tapes. You can choose either the side A or the side B.

For narrow space

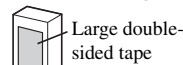

Attach

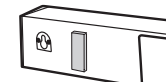

For wide space

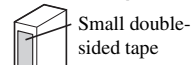

Attach

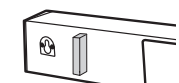

- 2-b:** Remove the mounting template and then install the commercially available screws at the marks.

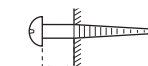

22 to 24 mm
(7/7" to 15/16")

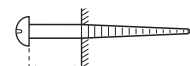

34 to 36 mm
(5/16" to 7/16")

Connection

- Do not connect the power cable until all connections are completed.
- Do not use excessive force when inserting the cable plug. Doing so may damage the cable plug and/or terminal.

Connecting the center system and the subwoofer/system control

Follow the procedure below to connect the center system and the subwoofer/system control.

Connecting speaker cables

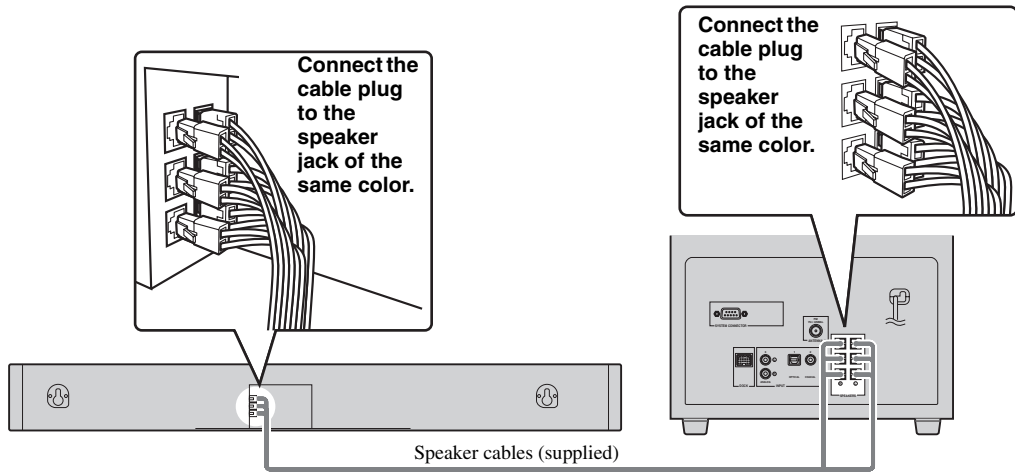

Connecting system control cable

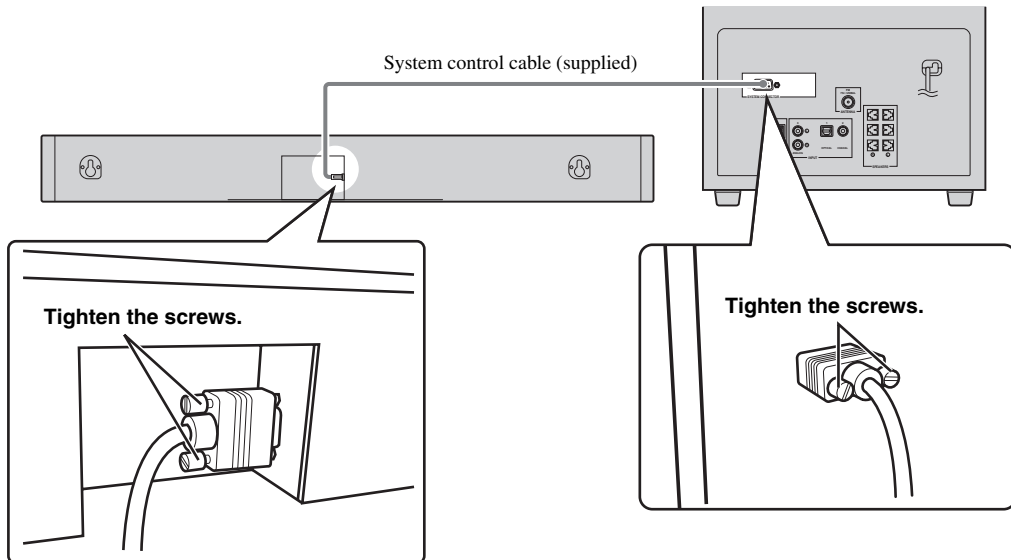

Connecting external components

The subwoofer/system control has 3 digital/analog input jacks (optical digital x 1, coaxial digital x 1, analog x 1). Before connecting your external components, check the output jacks of the components and be sure to use correct connection cables.

■ Digital connection

Notes

- The digital jacks of this system support PCM, Dolby Digital, and DTS signal system.
- The digital jacks support digital signals of which sampling frequency is 96 kHz or less.

[INPUT 1] OPTICAL jack

Example 1: DVD player

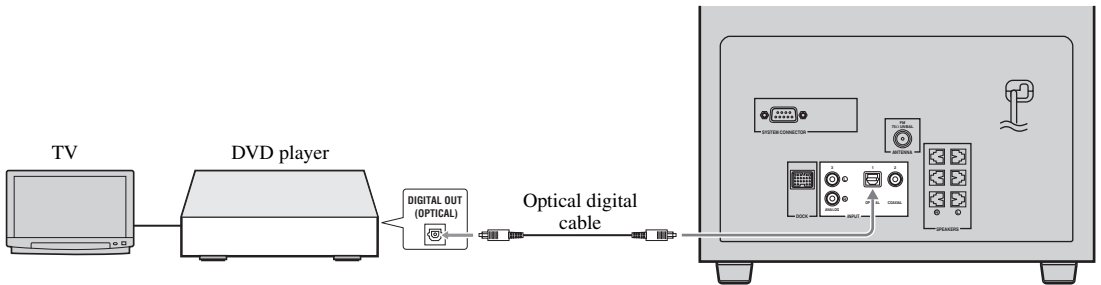

Example 2: TV game console

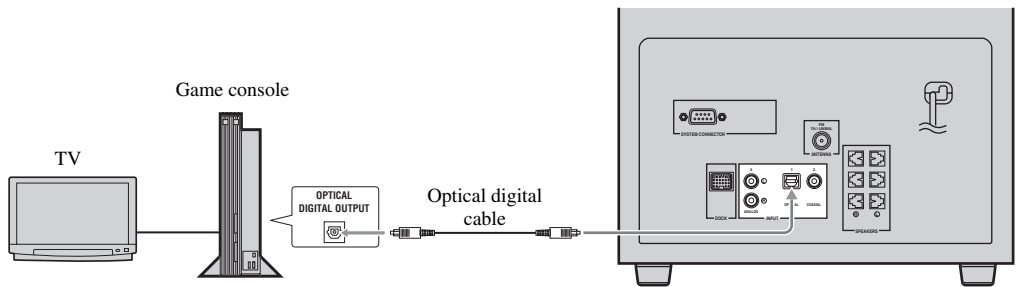

[INPUT 2] COAXIAL jack

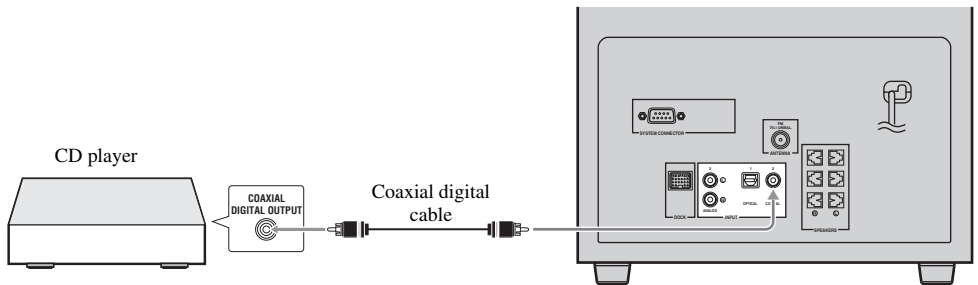

■ Analog connection

[INPUT 3] ANALOG jacks

Example1: TV

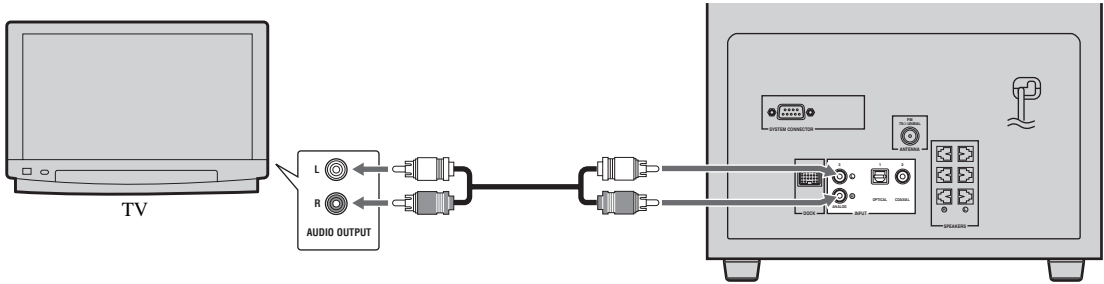

Example 2: VCR or video camera

VCR or video camera, etc. with no digital output.

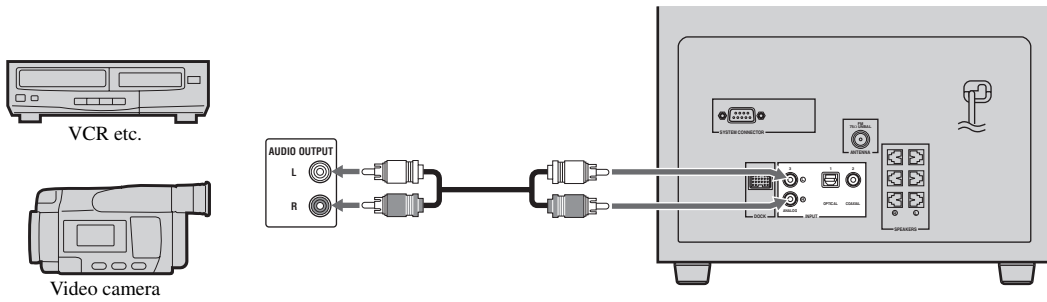

Connecting a Yamaha iPod universal dock

This system is equipped with the DOCK terminal that allows you to connect a Yamaha iPod universal dock (such as the YDS-10, sold separately) where you can station your iPod and control playback of your iPod using the supplied remote control. Connect a Yamaha iPod universal dock to the DOCK terminal of the subwoofer/system control using its dedicated cable.

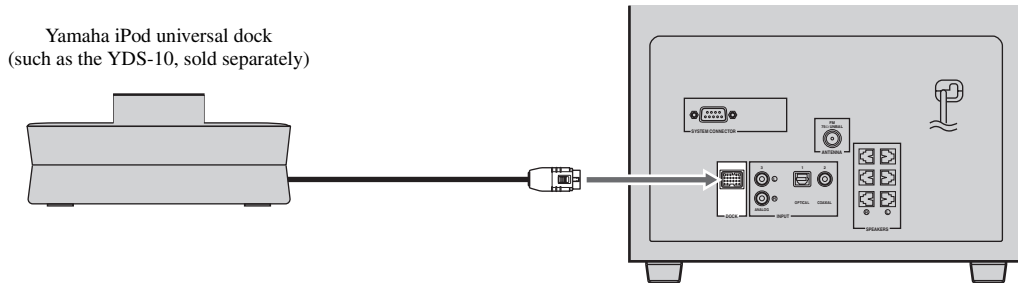

Connecting the indoor FM antenna

To enjoy FM radio broadcast, connect the supplied indoor FM antenna.

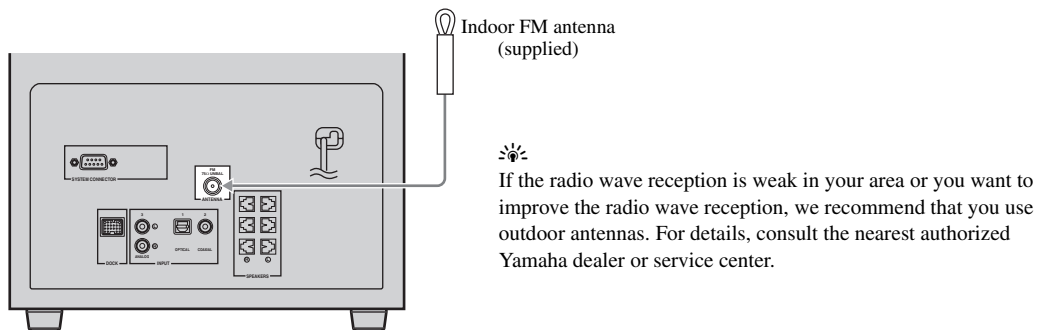

Connecting the power cable

After you made all connections, connect the power cable of the subwoofer/system control.

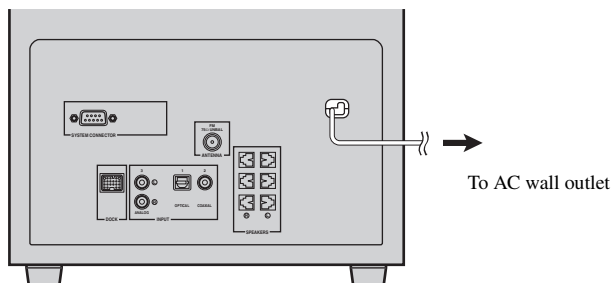

Basic playback operation

Once you have finished all cable connections (see pages 9 to 12) and remote control preparation (page 6), follow the procedure below to start basic playback operation.

1 Press **STANDBY/ON**.

This system turns on and the power indicator lights up. To set this system to the standby mode, press **STANDBY/ON** again.



This system has the auto-sleep function which automatically switches to the standby mode if you do not operate this system for about 24 hours while this system is turned on.

2 Press one of the input buttons to select an input source.

For example, if a DVD player is connected to the INPUT 1 jack of the subwoofer/system control, press **INPUT 1** to select the DVD player.



You can also switch the input source by pressing **INPUT** repeatedly. The input source changes as follows:

INPUT 1 → INPUT 2 → INPUT 3 → DOCK → FM

3 Start playback on the selected external component.

For information on the external component, refer to the manual for the product.

4 Press **VOLUME +/-** to adjust the volume level.



To turn off the volume temporarily, press **MUTE**. While the mute function is activated, the MUTE indicator flashes. To resume the volume, press **MUTE** again.

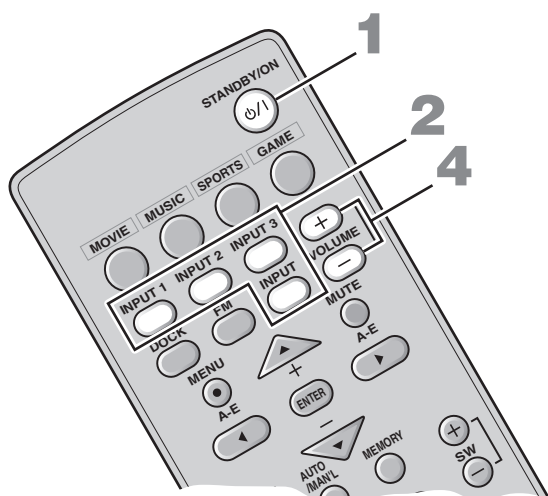

Now, try various features of this system!

Using various sound features

- To enjoy high realistic sounds with a sound field program [P. 14](#)
- To enjoy stereo sounds such as CD audio with multi channels [P. 15](#)
- To enjoy various input sources at lower volume [P. 15](#)
- To configure the position of virtual surround speakers [P. 22](#)

Enjoying FM broadcast/iPod playback

- To listen to FM broadcast [P. 16](#)
- To control iPod playback [P. 20](#)

Enjoying various sound features

The sound program features allow you to enjoy various kinds of audio such as movie or music. Choose a program based on your listening preference, and not purely on the name of the program.

Enjoying realistic sounds (Sound field program)

The sound field programs reproduce realistic sounds with the multi speaker channels.



This system automatically memorizes the settings assigned to each input source. When you select another input, this system automatically recalls the last settings for the selected input.

Press one of the sound field program buttons.

The name of the selected sound field program and the corresponding DSP indicator appear in the front panel display.

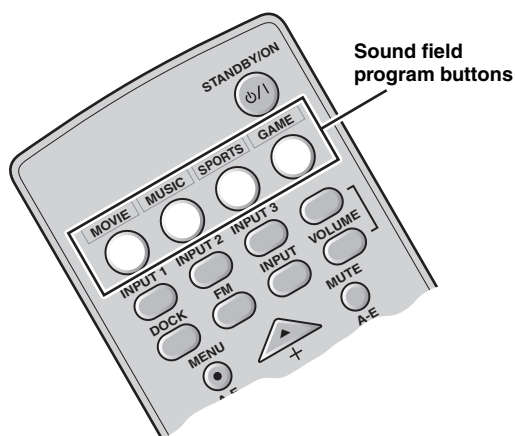

Sound field program descriptions

- MOVIE**
Movie
CINEMA DSP processing (see page 28) produces the rich acoustical presence of a movie theater.
- MUSIC**
Music
HiFi DSP processing magnifies the feeling of listening to live rock or jazz in a concert hall.
- SPORTS**
Sports
CINEMA DSP processing (see page 28) enhances the cheers and emotional whirl of the stadium with a center narrations in a live stereo sports broadcast.
- GAME**
Game
HiFi DSP processing gives TV games extra depth and surround.



- To reproduce the original sounds, press **DEC. MODE** repeatedly to select "AUTO".
- Pressing the selected sound field program button also returns to the original sound.

Enjoying stereo sounds with multi speaker channels (Dolby Pro Logic II)

The Dolby Pro Logic II modes reproduce 5.1-channel audio from stereo sounds.

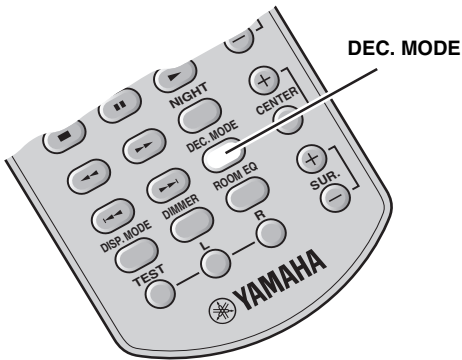

Press **DEC. MODE** repeatedly to select the desired Dolby Pro Logic II mode.

“PL II” appears in the front panel display.

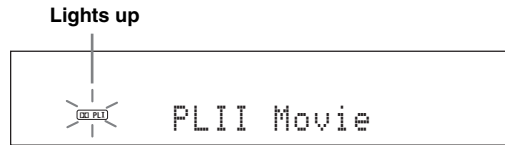

Each time you press the button, the mode changes as follows.

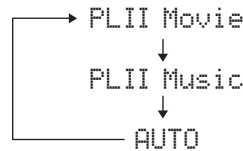

Decoder mode descriptions

PL II Movie

Dolby Pro Logic II processing for movie sources.

PL II Music

Dolby Pro Logic II processing for music sources.

AUTO

This unit decodes the input digital audio signals straightly with the corresponding decoder. If analog audio signals are input, this unit plays back the input source without any processing.

Listening at low volume (Night listening mode)

The night listening mode is designed to improve listenability at lower volumes. When you activate the night listening mode, you can enjoy realistic sounds with the effects of the selected sound field programs at lower volume.

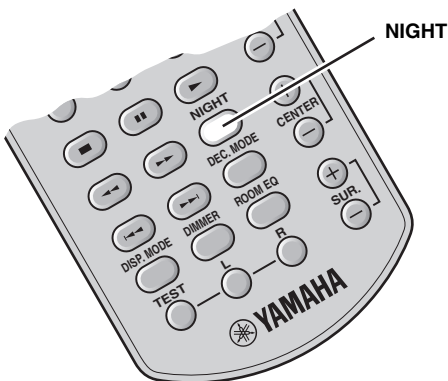

Press **NIGHT**.

“NIGHT ON” appears in the front panel display.

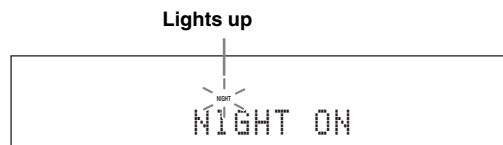

To cancel the night listening mode, press **NIGHT** again.

FM tuning

Overview

You can use two tuning modes to tune into the desired FM station:

Frequency tuning mode

you can search or specify the frequency of the desired FM station automatically or manually. (“Basic tuning operation” on page 17)

Preset tuning mode

You can preset the desired FM station in advance, and then recall the station by specifying the preset group and number. (“Using station preset feature” on page 18)

Controls and functions for the FM tuning

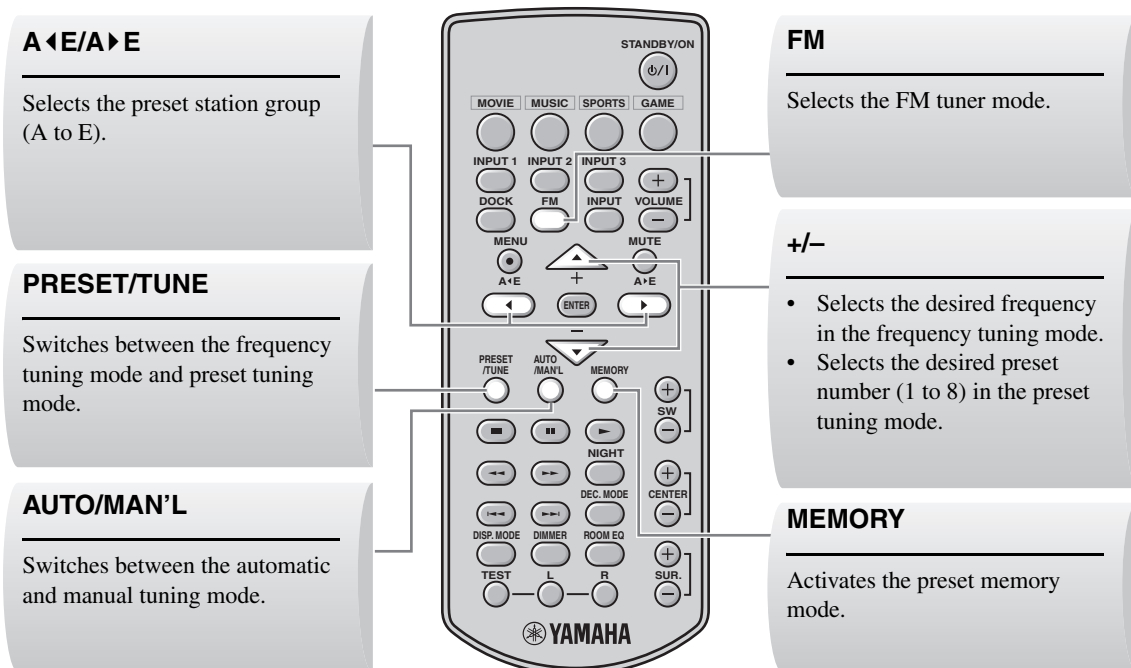

Basic tuning operation

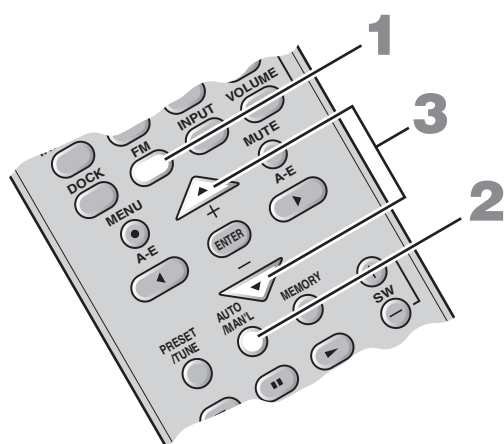

- 1 Press **FM** to select this system to the FM tuner mode.

“FM” appears in the front panel display.



- 2 Press **AUTO/MAN'L** so that the **AUTO** indicator lights up in the front panel display.

This system is set to the automatic tuning mode.

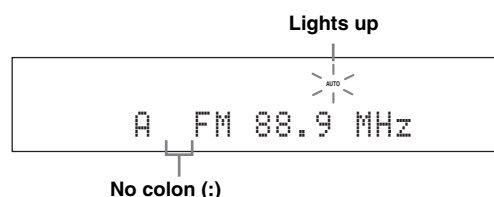

If a colon (:) appears, this system is set to the preset tuning mode and the frequency tuning is not possible. Press **PRESET/TUNE** to turn the colon (:) off.

- 3 Press **+/-** once to begin automatic tuning.

When this system is tuned into a station, the **TUNED** indicator lights up and the frequency of the received station is shown in the front panel display.

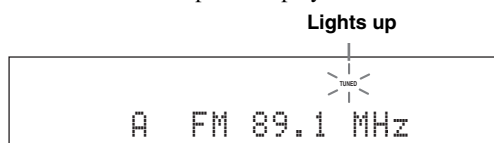

When you tune into an FM station by using the automatic tuning mode, this system receives the FM radio signal in the stereo reception mode. The **STEREO** indicator appears in the front panel display.

Manual tuning

If the signal received from the station you want to select is weak, you can tune into the desired station by specifying the frequency manually. In the FM tuning mode, press **AUTO/MAN'L** repeatedly so that the **AUTO** indicator disappears and then press **+/-** repeatedly to specify the frequency of the desired station.

If you tune into a station by using the manual tuning feature, this system receives the FM radio signals in the monaural reception mode to increase the signal quality.

Using station preset feature

Automatic station preset

First, scan the FM stations with strong signals and store them to the memory by using the automatic preset station feature. You can store up to 40 FM stations (A1 to E8: 8 preset station numbers in each of the 5 preset station groups).

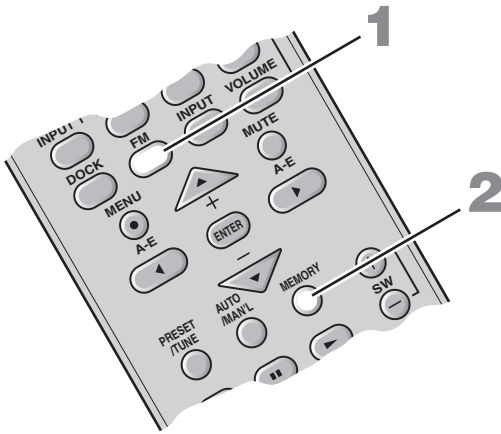

1 Press FM to select this system to the FM tuner mode.

“FM” appears in the front panel display.

2 Press and hold MEMORY for more than 3 seconds.

The preset station number as well as the MEMORY and AUTO indicators flashes. After approximately 5 seconds, automatic presetting starts from the current frequency and proceeds toward higher frequencies.

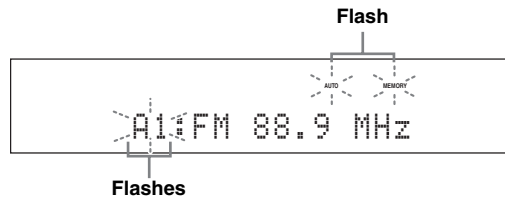

When automatic preset tuning is completed, the front panel display shows the frequency of the last preset station.



You can specify the preset number from which this system stores FM stations. Press **A◀E** or **A▶E** and then **+/-** repeatedly after you perform step 2 to select the preset station number under which the first station will be stored.

Notes

- Any stored station data existing under a preset station number is cleared when you store a new station under the same preset station number.
- If the number of received stations does not reach 40 (E8), automatic preset tuning automatically stops after searching for all the available stations.

If the desired station is not stored, or a station is not stored to the desired preset group and number, preset the station manually. Refer to “Manual station preset” on page 19 for details.

Recalling the preset stations

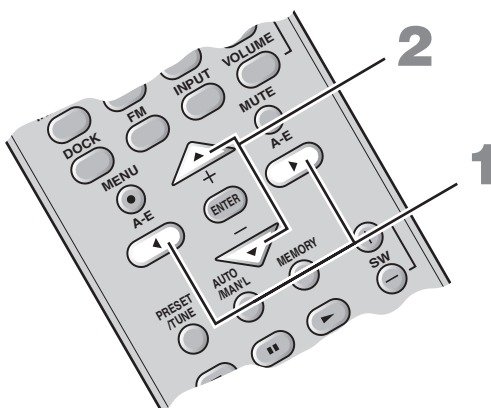

1 Press A◀E or A▶E repeatedly to select the desired preset station group (A to E).

2 Press +/- repeatedly to select the desired preset station number (1 to 8).

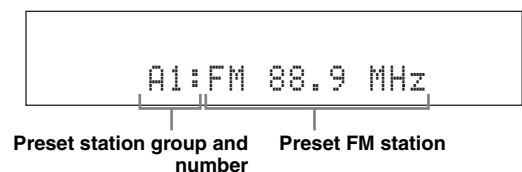

Manual station preset

Use this feature to preset your desired station manually.

1 Tune into a station.

See page 17 for tuning instructions.

2 Press **MEMORY**.

The **MEMORY** indicator flashes in the front panel display for approximately 10 seconds.

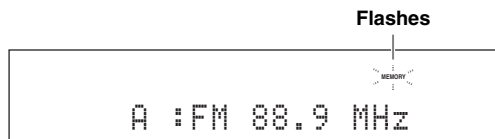
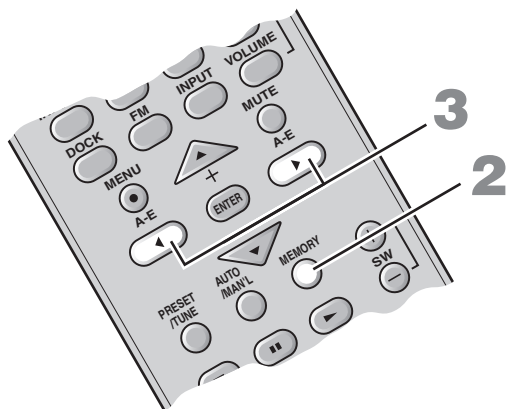

3 Press **A◀E** or **▶E** repeatedly to select a preset station group (A to E) while the **MEMORY** indicator is flashing.

The selected preset station group letter appears.

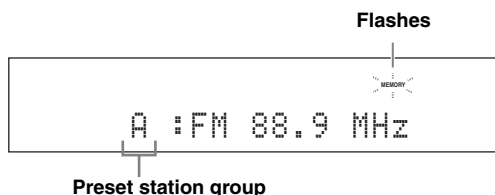

4 Press **+/-** to select a preset station number (1 to 8) while the **MEMORY** indicator is flashing.

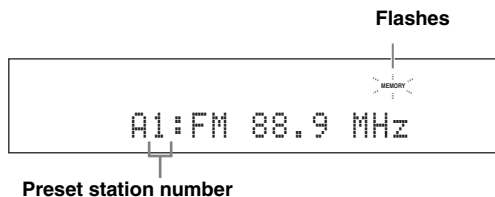
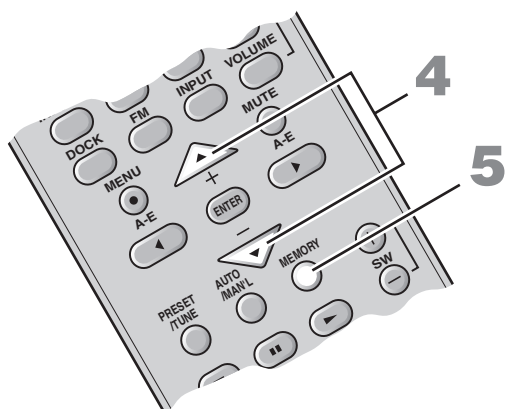

5 Press **MEMORY** to confirm the preset.

The station band and frequency appear in the front panel display with the preset station group and number you have selected. The **MEMORY** indicator disappears from the front panel display.

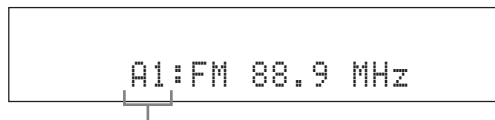

The displayed station has been stored as A1.

Notes

- Any stored station data existing under a preset station number is cleared when you store a new station under the same preset station number.
- The reception mode (stereo or monaural) is stored along with the station frequency.

Using iPod™

You can play back the audio sources stored on your iPod on this system.

Supported iPod

iPod (Click and Wheel)

iPod nano

iPod mini

Battery charge feature

This system charges the battery of the iPod stationed to the Yamaha iPod universal dock connected to the DOCK terminal of the subwoofer/system control while this system is turned on.

Stationing your iPod to the Yamaha iPod universal dock

Once you station your iPod to the Yamaha iPod universal dock, “iPod connected” and the DOCK indicator appears in the front panel display.

Controls and functions for iPod™

DOCK

Sets this system to the iPod playback mode.

Playback control buttons

Control the playback of the connected iPod.

▷/⏸: Play/pause

◻: Stop

◀◀/▶▶:

Search backward/forward

◀◀◀/▶▶▶:

Skip backward/forward

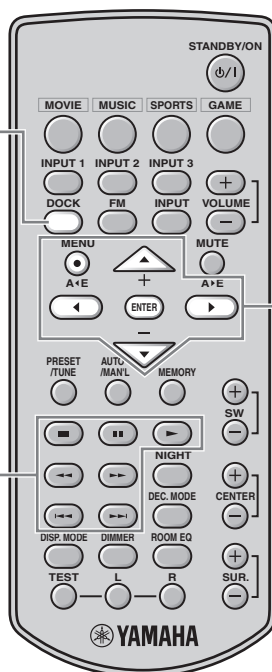

MENU/Cursor buttons (▲/▼/◀/▶)/ENTER

Navigate the menu of your iPod.

- Press **MENU** or ◀ to move to the previous menu level.
- Press ▲/▼ to move to the upper/lower menu level.
- Press **ENTER** or ▶ to move to the subsequent menu, start playback of the selected menu level, or change the selected setting.

Notes

- Operations can be also done with the controls on your iPod. Refer to the instruction manuals of your iPod for the operations on your iPod.
- Some features may not be compatible depending on the model or the software version of your iPod.
- For a complete list of status messages that appear in the front panel display, see the “iPod” section in “Troubleshooting” on page 26.

Useful operation

Changing the brightness of the front panel display

You can change the brightness of the front panel display.

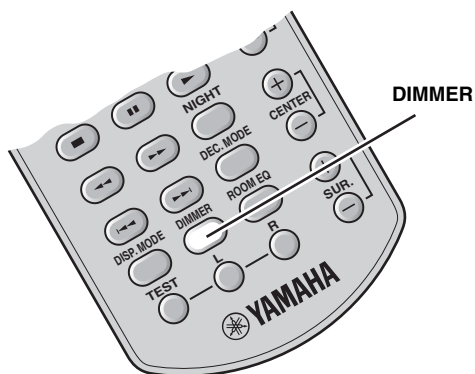

Press DIMMER repeatedly.

Each time you press **DIMMER**, the brightness of the front panel changes.

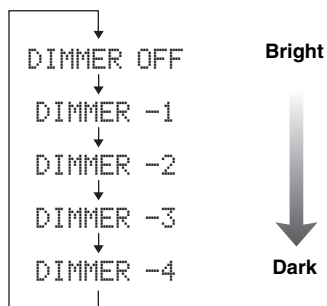

Turning off the front panel display

You can turn off the front panel display. This feature is useful when you enjoy a movie in a dark listening room.

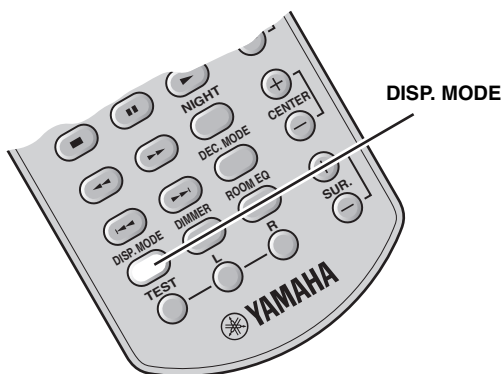

Press DISP. MODE.

After "DISPLAY OFF" appears in the front panel display, this system turns off the front panel display.



- The front panel display turns on momentarily when an operation is performed.
- To turn on the front panel display, press **DISP. MODE** again.

Adjusting the virtual speaker settings

Ordinarily, the 5.1 channel speaker system needs two front speakers, a center speaker, two surround speakers, and a subwoofer.

This system employs the Air Surround technology that enables you to enjoy the surround sound with the front left and right speakers in the center system; you can hear the center and surround channel sounds without the corresponding speakers.

Ordinal 5.1 channel speaker system

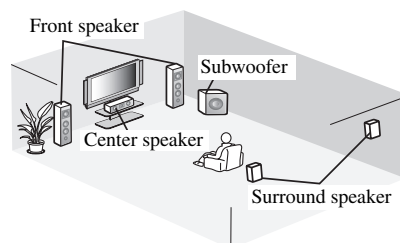

The sound image of this system

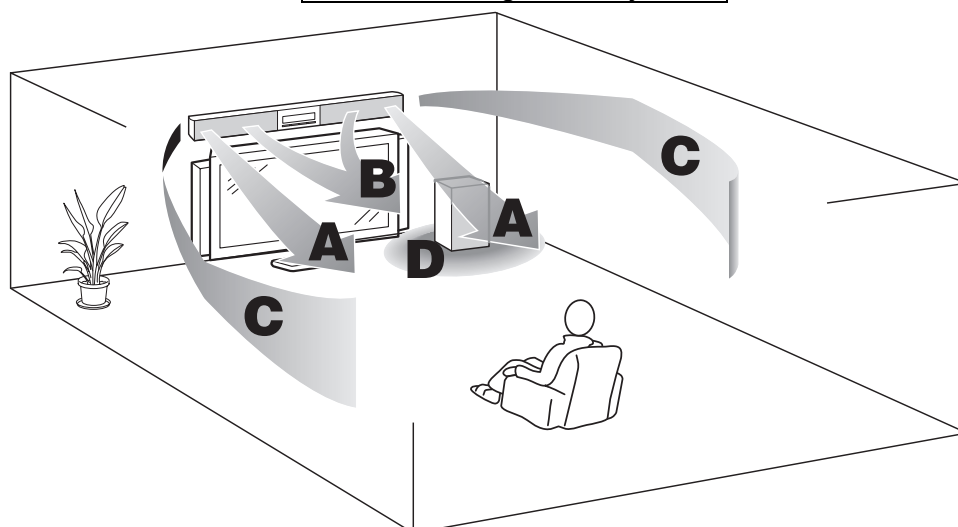

This unit creates the 5.1-channel surround sound with the center system and the subwoofer/system control.

A: Front left and right
B: Virtual center channel

C: Virtual surround left and right channel
D: Low-frequency or LFE channel

In this section, you can adjust the following surround sound settings for your preference and the characteristics of your listening room:

- **Adjusting the volume balance of each channel with test tones** 📖 P. 23
By adjusting the balance, you can enjoy seamless surround sound.
- **Adjusting the positions of the virtual surround speaker channels with test tones** 📖 P. 24
This unit creates the surround channel sounds that locate the side or behind of the listening position by using the reflection of the walls. Use this setting to locate the surround channel sounds.
- **Adjusting the characteristics of the tonal quality** 📖 P. 25
Use this feature to adjust the tonal quality according to the acoustic characteristics of your listening room. This feature is useful if the sound is too dark or bright.
- **Adjusting the volume balance during playback** 📖 P. 25
Use this feature to adjust the volume balance of the subwoofer, center, and surround channels during playback. This feature is useful when you want to change the volume balance tentatively.

Using the speaker test mode

Use this feature to adjust the volume balance of each (virtual) speaker and the position of the virtual surround speakers.

■ Adjusting the volume balance of each channel

1 Press **TEST** to activate the speaker test mode.

Following message appears in the front panel display and this system outputs the test tones.

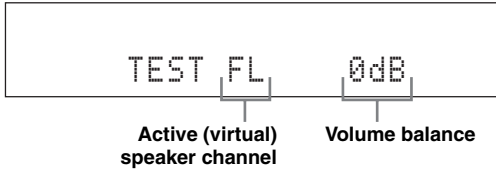

Test tone is output at each (virtual) speaker for about 2.5 seconds in the following order.

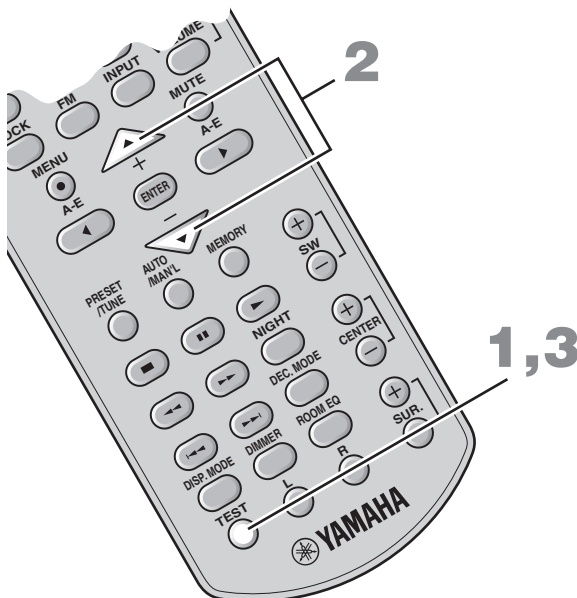
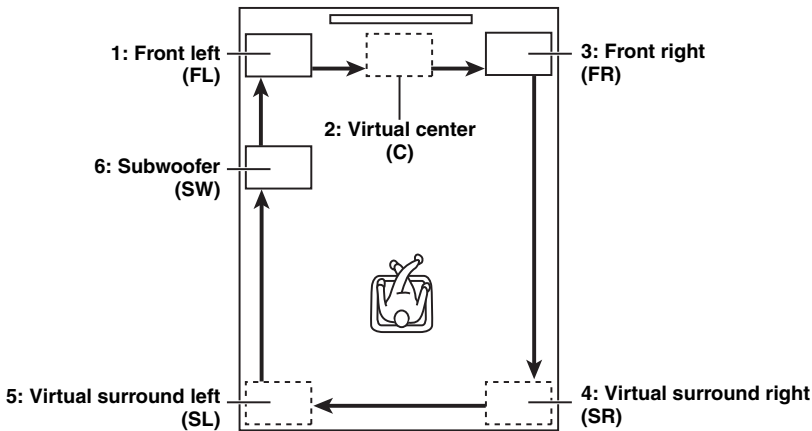

2 Press **▲/▼** repeatedly to adjust the output level of the currently selected (virtual) speaker channel.

The adjustable range for the output level of each speaker channel is as follows:

Front left/right (FL/FR): -6 to 0 dB

Center (C): -4 to +4 dB

Surround left/right (SL/SR): -4 to +4 dB

Subwoofer (SW): -8 to +8 dB

3 Press **TEST** again to exit from the speaker test mode.



- To reset the volume level and the beam angle (see page 24) of all virtual speaker channels to the factory settings, press **INPUT** on the front panel while a test tone is output.
- You can adjust overall the volume level of the test tone using **VOLUME +/-**.

■ Adjusting the position of the virtual surround speakers

This system employs the Yamaha Air Surround system that enables the surround sound field using the center system and the subwoofer/system control. This system creates the surround sounds by using the reflections on the walls of your listening room. Use this feature to achieve the ideal surround sound.



To reset the volume level and the beam angle of all virtual speaker channels to the factory settings, press **INPUT** on the front panel while a test tone is output.

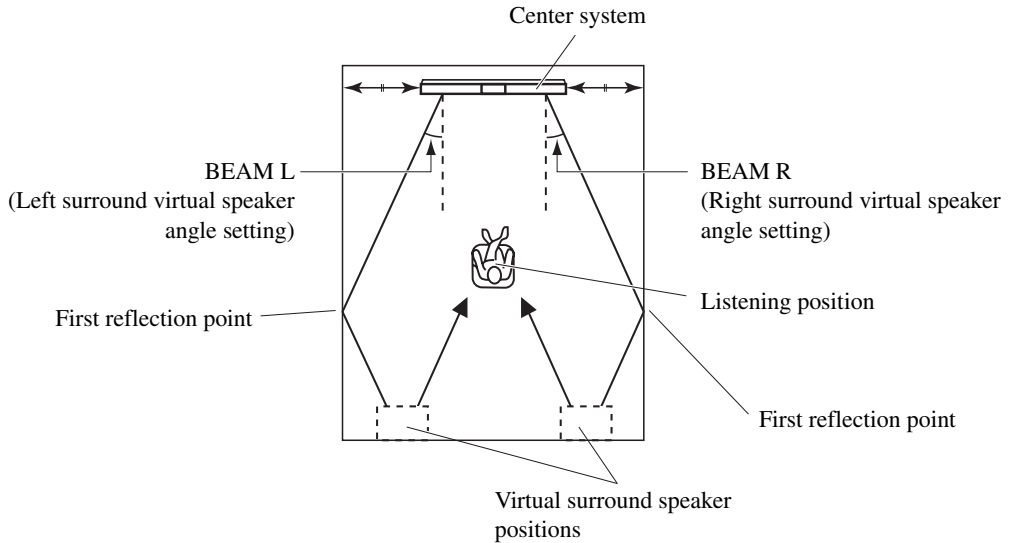

Adjust the angle so that the first reflection point is located posterior to the listening position and the sound of surround speaker channel audio reaches the listening position after reflections.

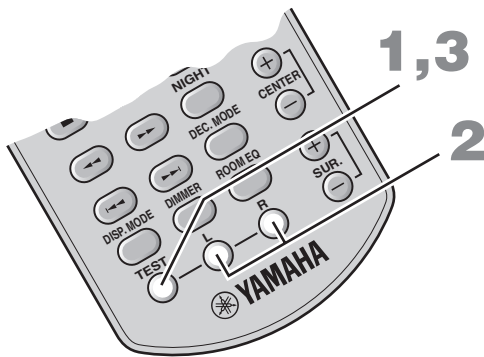

1 Press **TEST** to activate the speaker test mode.

This system outputs test tones.

2 Press **L** or **R** repeatedly to select the desired angle setting of the left or right surround virtual speaker channel.

“BEAM L” or “BEAM R” and the angle setting appears in the front panel display.

Choice: 20°, 30°, 40°, 50°, 60°

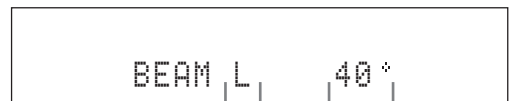

Selected virtual surround speaker channel

Current angle setting

3 Press **TEST** again to exit from the speaker test mode.



This system automatically returns to the speaker balance setting mode after a few seconds that you perform the operation of step 2.

Adjusting the characteristics of the tonal quality (ROOM EQ)

Use this feature to set the equalizer to optimize the tonal quality of the sound for the acoustic characteristics of your listening room.

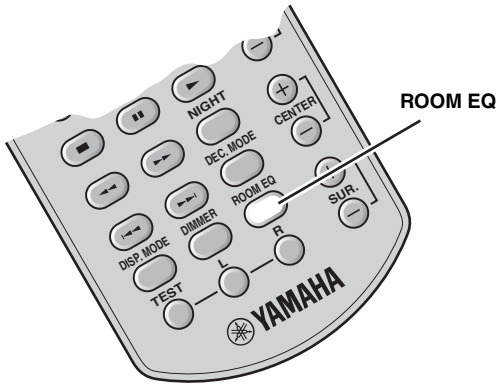

Press **ROOM EQ** repeatedly to select the desired room equalizer setting.

Choice	Descriptions
HARD	If the walls in your listening room are hard and you can get the sufficiently reflected sounds
SOFT	If the walls are covered over some soft objects or there are some furniture on the walls and you cannot get the sufficiently reflected sounds

Adjusting the speaker balance during playback

You can also adjust the output level of the virtual center, virtual surround speakers, and subwoofer during playback.

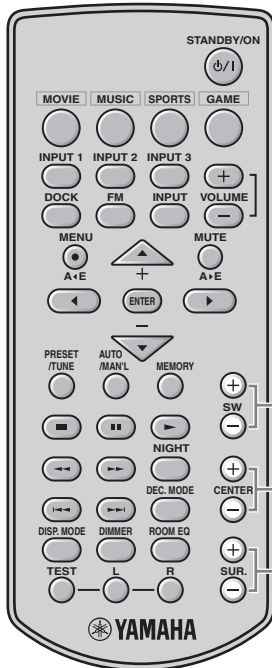

SW +/-

Adjusts the output level of the subwoofer channel.
Control range: +8 to -8

CENTER +/-

Adjusts the output level of the virtual center speaker channel.
Control range: +4 to -4

SUR. +/-

Adjusts the output level of the virtual surround speaker channels.
Control range: +4 to -4

Additional information

Troubleshooting

If there is any problem with this system, check the following items. If you cannot solve your problem with the following remedies or if your problem was not listed below, turn off and unplug this system, and then consult the nearest authorized Yamaha dealer or service center.

Problem	Cause	Solution	See page
Power turns on but immediately shuts off.	The power cable may be connected improperly.	Make sure the power cable is plugged into the outlet firmly.	12
	The speaker cable may be shorted.	Make sure all speaker cables are connected properly.	9
	This system may receive a strong electrical shock such as from a lightning bolt or excessive static electricity.	Set this system to the standby mode, and then disconnect the power cable. Wait for about 30 seconds, connect the power cable, and then turn on this system.	13
The speakers make no sound.	The volume may be set to minimum level.	Adjust the volume level.	13
	The mute function may be activated.	Cancel the mute function.	13
	The input source or input setting may be incorrect.	Select the correct input source or input setting.	13
	The cables may be connected improperly.	Make sure all cables are connected properly.	9, 12
Sound is too low on one side.	The cables may be connected improperly.	Make sure all cables are connected properly.	9, 12
Speaker channels other than the front ones make no sound.	You may be listening to stereo sounds without the sound field effect.	Press sound field program button to enable the sound field effect.	14
The center speaker channel makes no sound.	The volume of the center speaker channel may be set to minimum level.	Adjust the volume level of the center speaker channel using test tones.	23
The surround speaker channels make no sound.	The volume of the surround speaker channels may be set to minimum level.	Increase the output level of SL/SR by pressing ▲.	23
		Increase the output level of the virtual surround speaker channel by pressing SUR. +.	25
The subwoofer makes no sound.	The volume of the subwoofer channel may be set to minimum level.	Adjust the volume level of the subwoofer.	25
	You may be listening to an audio source that does not contain any low tone signal.	The subwoofer does not support signals outside the specified range.	23
Sound is poor (noisy).	The speaker cable may be shorted.	Make sure all cables are connected properly.	9, 12
This system does not operate properly.	This system may receive a strong electrical shock, such as from a lightning bolt or excessive static electricity, or drop in power supply.	Set this system to the standby mode, and then disconnect the power cable. Wait for about 30 seconds, connect the power cable, and then turn on this system.	13
	The system control cable may be connected improperly.	Connect the system cable firmly.	9
A digital or high-frequency equipment produces noises.	This system may be placed close to the digital equipment or high-frequency equipment.	Place this system further away from such equipment.	—

Problem	Cause	Solution	See page
The remote control does not work for operating this system.	This system may be operated outside the remote control operation range.	For information on the remote control operation range, refer to "Remote control".	5
	The remote control sensor of this system may be exposed to direct sunlight of lighting.	Change the lighting.	—
	The batteries may be worn out.	Replace the batteries.	5

■ Tuner

Problem	Cause	Remedy	See page
FM stereo reception is noisy.	The characteristics of FM stereo broadcasts may cause this problem when the transmitter is too far away or the antenna input is poor.	Check the antenna connections.	12
		Try using a high-quality directional FM antenna.	—
		Use the manual tuning method.	17
There is distortion, and clear reception cannot be obtained even with a good FM antenna.	There is multi-path interference.	Adjust the antenna position to eliminate multi-path interference.	—
The desired station cannot be tuned into with the automatic tuning method.	The signal is too weak.	Use a high-quality directional FM antenna.	—
		Use the manual tuning method.	17
Previously preset stations can no longer be tuned into.	This system has been disconnected for a long period and preset station memory has been cleared.	Set preset stations again.	18

■ iPod

Note

In case of a transmission error without a status message appearing in the front panel, check the connection to your iPod (page 12).

Status message	Cause	Remedy	See page
Unknown iPod	The iPod being used is not supported by this system.	Only iPod (Click and Wheel), iPod nano, and iPod mini are supported.	—
iPod connected	Your iPod is properly stationed in a Yamaha iPod universal dock (such as YDS-10, sold separately) connected to the DOCK terminal of this system, and the connection between your iPod and this system is completed.		
Disconnected	Your iPod was removed from a Yamaha iPod universal dock (such as YDS-10, sold separately) connected to the DOCK terminal of this system.	Station your iPod back in a Yamaha iPod universal dock (YDS-10, sold separately) connected to the DOCK terminal of this system.	12

Glossary

■ Air Surround

Front surround sound system which is developed by Yamaha enables the surround sound field. In comparison with traditional front surround technologies, the Air Surround system enables a wide range of natural surround sound field.

■ Channel (ch)

A channel is an audio type that has been divided based on range and other characteristics.

Ex. 5.1 channel

- Front speakers, Left (1ch), Right (1ch)
- Center speaker (1 ch)
- Surround speakers, Left (1ch), Right (1ch)
- Subwoofer (1 ch x 0.1* = 0.1 ch)

* In contrast to a full 1-channel band, a component designed to enhance low frequency sound for added effect.

■ CINEMA DSP (Digital Sound Field Processor)

Since the Dolby Surround and DTS systems were originally designed for use in movie theaters, their effect is best felt in a theater having many speakers and designed for acoustic effects. Since home conditions, such as room size, wall material, number of speakers, and so on, can differ so widely, it's inevitable that there are differences in the sound heard as well. Based on a wealth of actually measured data, Yamaha CINEMA DSP uses Yamaha original sound field technology to combine Dolby Pro Logic, Dolby Digital and DTS systems to provide the visual and audio experience of movie theater in the listening room of your own home.

■ Dolby Digital

Digital surround sound system which is developed by Dolby Laboratories provides completely independent multi-channel audio. With 3 front channels (left, center, and right) and 2 surround stereo channels, Dolby Digital provides five full-range audio channels. With an additional channel especially for bass effects (called LFE, or low frequency effect), the system has a total of 5.1-channels (LFE is counted as 0.1 channel). By using 2-channel stereo for the surround speakers, more accurate moving sound effects and surround sound environment are possible than with Dolby Surround.

■ Dolby Pro Logic II

It is an improved matrix decoding technology that provides better spatiality and directionality on Dolby Surround programmed material; provides a convincing three-dimensional sound field on conventional stereo music recordings; and is ideally suited to the surround experience to automotive sound. While conventional surround programming is fully compatible with Dolby Surround Pro Logic II decoders, soundtracks will be able to be encoded specifically to take full advantage of Pro Logic II playback, including separate left and right surround channels.

■ DTS

Digital surround sound system developed by DTS, Inc., which provides 5.1 channel audio. With an abundance of audio data, it is able to provide authentic-sounding effects.

■ PCM (Pulse Code Modulation)

A signal that is changed to digital format without compression. A CD is recorded with 16-bit sound at 44.1 kHz, while DVD recording is anywhere from 16 bits at 48 kHz to 24 bits at 192 kHz, which makes it a higher quality sound than CD.

■ Sampling frequency

The number of sampling (process for digitalizing analog signals) per second. In principle, the higher the sampling rate, the wider the frequency range that can be played back, and the higher the quantized bit rate, the finer the sound that can be reproduced.

Specifications

YAS-70CU

- Type Full range acoustic suspension magnetic shielding type
- Driver (Full range) 5 cm (2") cone magnetic shielding type × 6 (L3, R3)
- Frequency Response 100 Hz to 25 kHz
- Input impedance 6 Ω
- Maximum Input 35 W
- Sensitivity (2.83 V, 1 m) 84 dB
- Dimensions (W × H × D) 930 × 100.5 × 103 mm
(Approx. 36-5/8" × 3-15/16" × 4-1/16")
- Weight 4.5 kg
(Approx. 9 lbs. 15 oz.)

YAS-70SPX

Amplifier

- Minimum RMS output power per channel 30 W (1 kHz, 6 Ω, 1% THD)
- Maximum power 35 W (6 Ω, 10% THD)



This system employs Yamaha Air Surround system which enables the surround sound field using six speaker units built in center system.



This system employs Advanced Yamaha Active Servo Technology which Yamaha has developed for reproducing higher quality super-bass sound.

FM Tuner

- Tuning range 87.5 to 107.9 MHz
- Antenna Input (unbalanced) 75 Ω

Subwoofer

- Type Advanced Yamaha Active Servo Technology System
- Output Power 50 W (100 Hz, 5Ω, 10% T.H.D)
- Dynamic Power 100 W, 5Ω
- Driver 16 cm (6 1/2") cone, Magnetic shielding type
- Frequency Response 30 Hz to 200 Hz
- Input impedance 12 kΩ

Other sections

- Power supply AC 120 V, 60 Hz
- Power consumption 60 W
- Standby Power Consumption 0.9 W
- Dimensions (W × H × D) 281 x 495.5 x 340 mm
(Approx. 11 1/16" × 19 1/2" × 13 3/8")
- Weight 15.0kg
(Approx. 33 lbs. 1 oz.)

* Specifications are subject to change without notice.



Manufactured under license from Dolby Laboratories. "Dolby", "Pro Logic" and the double-D symbol are trademarks of Dolby Laboratories.



"DTS" and "DTS Digital Surround" are registered trademarks of DTS, Inc.



© 2007 YAMAHA CORPORATION All rights reserved.

YAMAHA ELECTRONICS CORPORATION, USA 6660 ORANGETHORPE AVE., BUENA PARK, CALIF. 90620, U.S.A.
YAMAHA CANADA MUSIC LTD. 135 MILNER AVE., SCARBOROUGH, ONTARIO M1S 3R1, CANADA
YAMAHA ELECTRONIK EUROPA G.m.b.H. SIEMENSSTR. 22-34, 25462 RELINGEN BEI HAMBURG, GERMANY
YAMAHA ELECTRONIQUE FRANCE S.A. RUE AMBROISE CROIZAT BP70 CROISSY-BEAUBOURG 77312 MARNE-LA-VALLEE CEDEX02, FRANCE
YAMAHA ELECTRONICS (UK) LTD. YAMAHA HOUSE, 200 RICKMANSWORTH ROAD WATFORD, HERTS WD18 7GQ, ENGLAND
YAMAHA SCANDINAVIA A.B. J A WETTERGRENS GATA 1, BOX 30053, 400 43 VÄSTRA FRÖLUNDA, SWEDEN
YAMAHA MUSIC AUSTRALIA PTY, LTD. 17-33 MARKET ST., SOUTH MELBOURNE, 3205 VIC., AUSTRALIA

YAMAHA CORPORATION
Printed in Malaysia ◀ WM26020