

# HTR-3064

## Quick Reference Guide

### Accessories

The following accessories are supplied with this product.

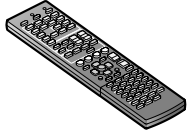

Remote control

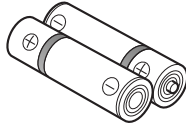

Batteries (2) (AAA, R03, UM-4)

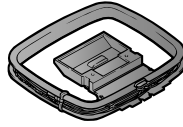

AM loop antenna



Indoor FM antenna

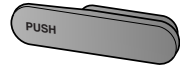

VIDEO AUX input cover

### Preparing the remote control

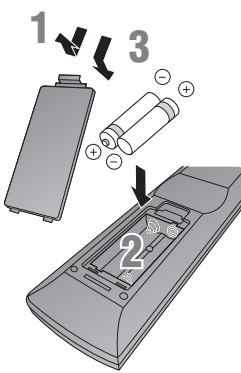

- 1 Take off the battery compartment cover.
- 2 Insert the two supplied AAA batteries into the battery case, following the polarity markings.
- 3 Snap the battery compartment cover back into place.

### Items necessary for connection

#### Speakers



Ex.

Front speaker



Ex.

Center speaker



Ex.

Surround speaker

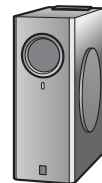

Ex.

Active subwoofer

- Use speakers with an impedance of at least 6Ω.
- If you are using a CRT TV, we recommend that you use magnetically shielded speakers.
- Prepare at least two speakers (for front). The priority of the other speakers is as follows:
  - 1 Two surround speakers
  - 2 One center speaker

#### External components



TV



 Playback device such as BD  
(Blu-ray Disc)/DVD players

#### Cable

- Cables for connecting external components  
(may differ depending on the devices you are connecting)
- Speaker cables  
(a quantity to match the number of speakers you are connecting)
- Audio pin cable  
(for subwoofer)

Connect and install as follows the first time you use this unit.

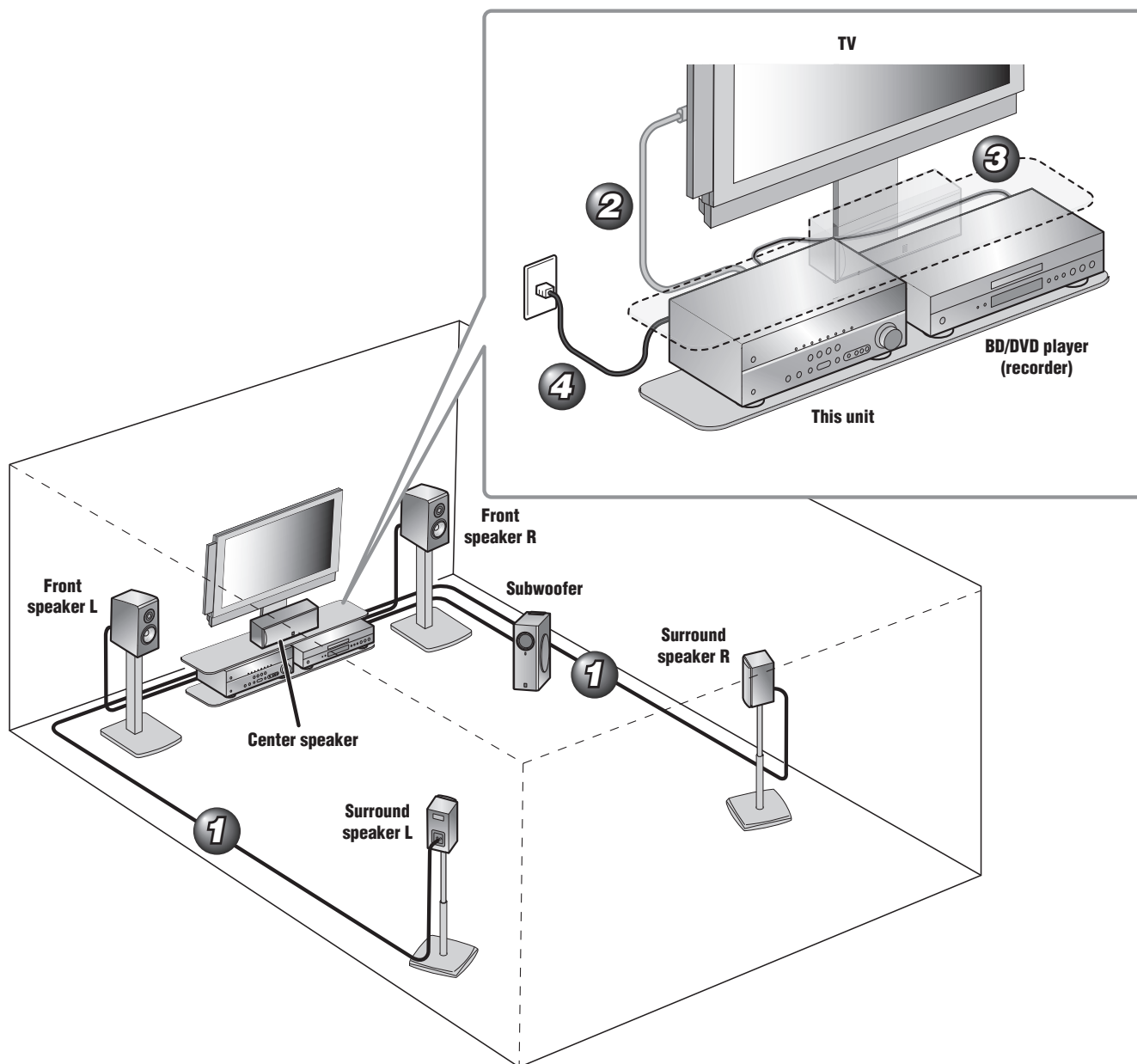
See the following explanations for the connections for each number.



**1** Connect the speakers

**2** Connect a TV

**3** Connect playback device such as BD/DVD players and recorders

**4** Connect the AC power cord, and turn the power on

When connection and installation is finished, set up the speaker parameters **5** .

# 1 Connect the speakers

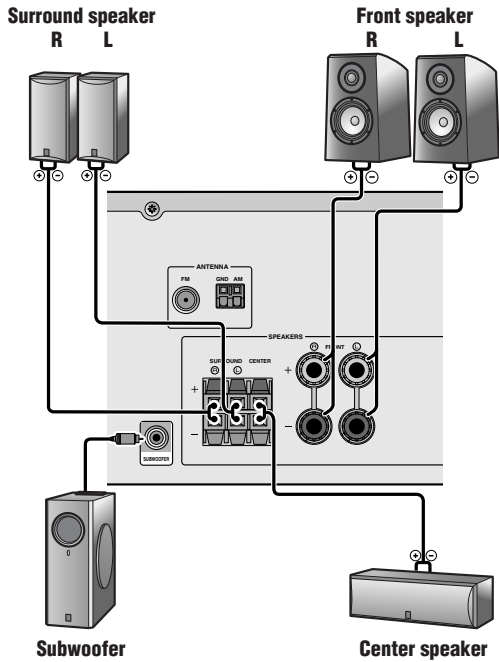

## Caution:

- Remove the AC power cord of this unit from the power outlet before connecting the speakers.
- Generally speaker cables consist of two parallel insulated cables. One of these cables is a different color, or has a line running along it, to indicate different polarity. Insert the different colored (or lined) cable into the “+” (positive, red) terminal on this unit and the speakers, and the other cable into the “-” (minus, black) terminal.
- Be careful that the core of the speaker cable does not touch anything or come into contact with the metal areas of this unit. This may damage this unit or the speakers. If the speaker cables short circuit, “CHECK SP WIRES!” will appear on the front panel display when this unit is switched on.
- When connecting 6Ω speakers, set the speaker impedance to 6Ω on this unit before making connections. Refer to Owner’s Manual for information on settings.

## Connecting front speakers

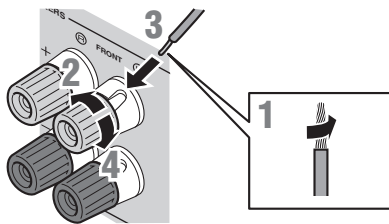

- 1 Remove approximately 10mm of insulation from the ends of the speaker cables, and twist the bare wires of the cables together firmly so that they will not cause short circuits.
- 2 Loosen the speaker terminals.
- 3 Insert the bare wire of the speaker cable into the gap on the side of the terminal.
- 4 Tighten the terminal.

## Connecting the banana plug (Except U.K., Europe, Asia and Korea models)

Tighten the knob, and then insert the banana plug into the end of the terminal.

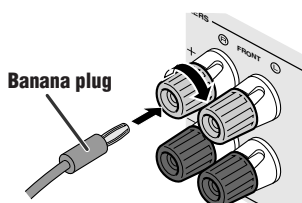

## Connecting center speakers / surround speakers

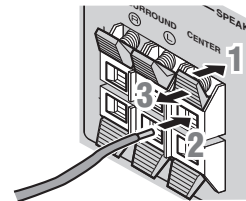

- 1 Press the tab on the speaker terminal down.
- 2 Insert the speaker cable end into the terminal.
- 3 Lift the tab to fix the speaker cable in place.

## Connecting the subwoofer

- 1 Connect the subwoofer input jack to the SUBWOOFER jack on this unit with an audio pin cable.

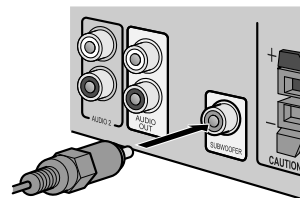

- 2 Set the subwoofer volume as follows.  
Volume: Set to approximately half volume (or slightly less than half).  
Crossover frequency (if available): Set to maximum.

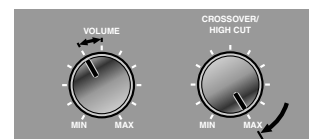

Subwoofer examples

## 2 Connect a TV

Video input to this unit is output to a TV using output jacks of the same kind.

When you have made connections using different types of video such as HDMI and component video, make the same connection with your TV. When viewing, be sure to switch the input source on your TV to match the playback device.

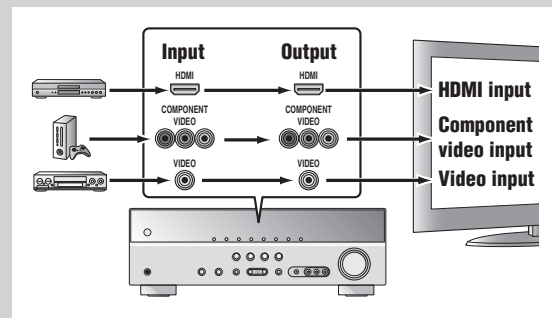

If your TV has multiple inputs, connect with the following priority (A) to (C).

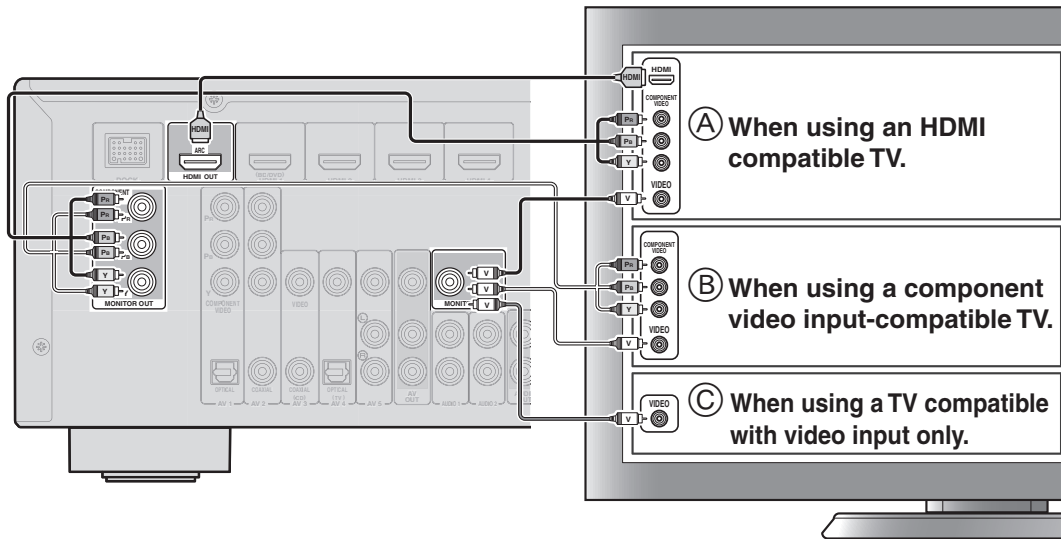

### Listening to TV audio

To playback TV audio on this unit, connect the TV audio output to this unit.

Connect the following input jacks, matching the audio output jacks on your TV. When viewing your TV, select the appropriate input source on this unit.

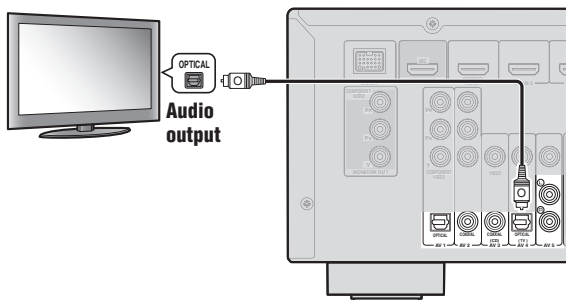

Audio output from TV	Input jack on this unit
Optical digital output	AV1 or AV4
Coaxial digital output	AV2 or AV3
Analog output	AV5, AUDIO1, AUDIO2, or V-AUX
HDMI Audio Return Channel (Described in the right column)	HDMI OUT

\* Connecting to AV4 allows you to playback TV audio just by pressing the "TV" under "**SCENE**" key.

When using an HDMI compatible TV that supports Audio Return Channel functions and / or HDMI Control functions (Ex. Panasonic VIERA Link), you can enjoy the TV sound on this unit as follows:

#### When using a TV that supports the Audio Return Channel functions and HDMI Control functions

The audio / video output from the unit to the TV and audio output from the TV to the unit are possible using a single HDMI cable.

The input source is switched automatically to match operations carried out on the TV, and that makes TV sound control easier to use.

For the connections and settings, refer to "Single HDMI cable input to TV audio with Audio Return Channel function" in Owner's Manual.

#### When using a TV that supports HDMI Control functions

When HDMI Control functions are enabled on the unit, input source can be switched automatically to match operations carried out on the TV.

For the connections and settings, refer to "Switching the input source on this unit automatically when listening to TV audio" in Owner's Manual.

### 3 Connect playback device such as BD/DVD players and recorders

If your playback device has multiple audio/video outputs, connect with the following priority (A to D) to enjoy a higher quality sounds and images.

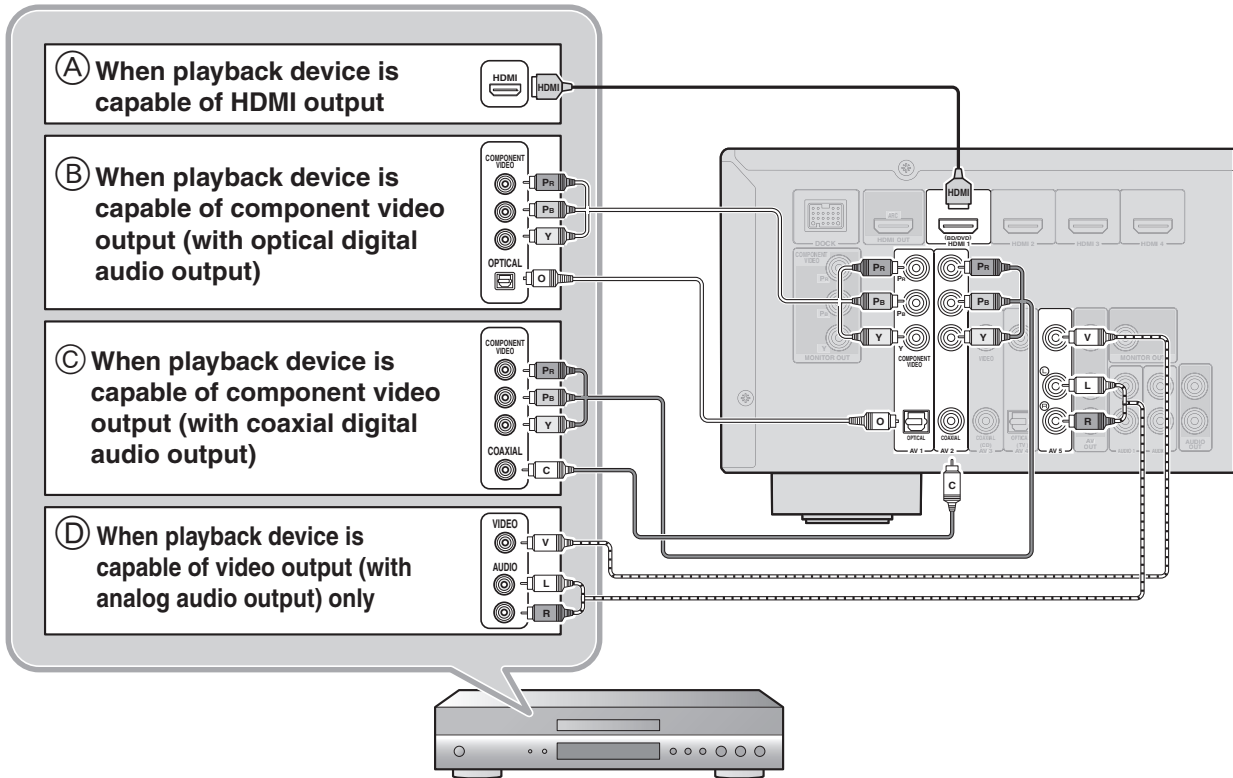

- When playback, select the corresponding input source the jack is connected.
- Connecting to HDMI1 allows you to select the HDMI input just by pressing the "BD/DVD" under "SCENE" key.
- Connecting to AV3 allows you to select the AV3 input just by pressing the "CD" under "SCENE" key.
- If necessary, you can connect components that cannot be connected using the above methods, such as devices that output video from component video output jacks and audio from analog output jacks. Refer to Owner's Manual for details.

### 4 Connect the AC power cord, and turn the power on

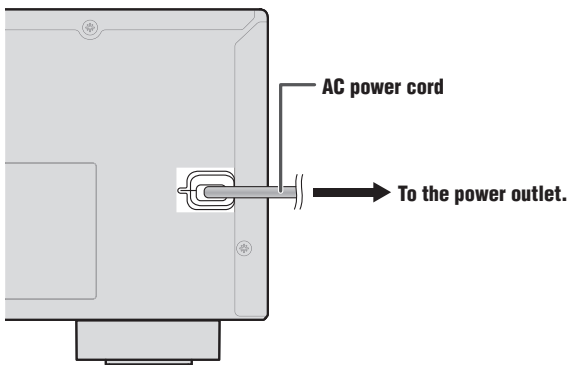

Be sure to aim the remote control directly at the remote control sensor on this unit during operation.

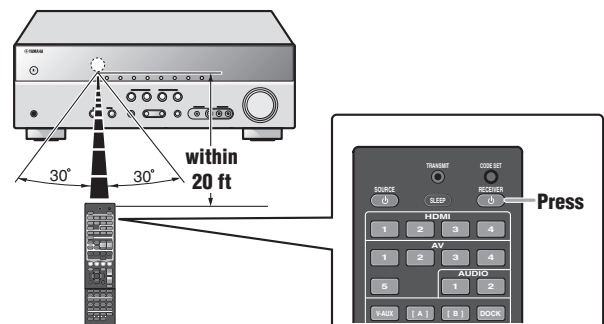

## 5 Set up speaker parameters

When you finish connecting, adjust the status, size, and volume of each speaker so that the output is normal.

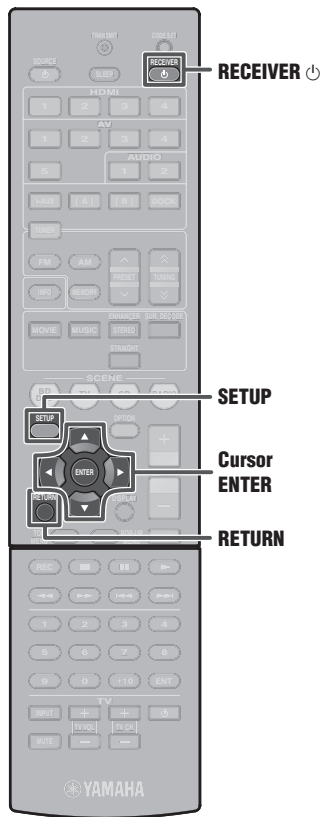

### STEP 1: Display the setting menu

- 1 Press **RECEIVER** on the remote control to switch this unit on.
- 2 Press **SETUP** on the remote control.
- 3 Check that "Speaker Setup" appears and press **ENTER**.



This completes step 1.

### STEP 2: Set the speaker status and size

The settings in step 2 are not necessary with the following speaker configuration:

- Front speaker: woofer diameter is 16 cm or larger
- Center/surround speakers: woofer diameter is 16 cm or smaller
- Subwoofer: connected

- 4 Check that "Config" appears and press **ENTER**.



- 5 Use **Cursor** / to select the speaker (subwoofer) you want to configure, and then use **Cursor** / to select speaker status and size.

Information	Description	Setting
Subwoofer	Sets the subwoofer status.	Yes/None
Front	Selects the size (sound reproduction capacity) of the front speakers.	Small/Large
Center	Selects the size of the center speakers. Choose "None" if you do not have a speaker connected.	None/Small/Large
Sur. LR	Selects the size of the surround speakers. Choose "None" if you do not have a speaker connected.	None/Small/Large
Crossover	Audio with a frequency below this limit will be output from the subwoofer or the front speakers.	40 Hz to 200 Hz
SWFR Phase	Switches the phase of the subwoofer.	NRM/REV
Extra Bass	Selects whether to play front channel low-frequency components through either the front speakers or the subwoofer (Off), or through both the subwoofer and front speakers (On).	On/Off

- Whether or not you set "Crossover," "SWFR Phase," and "Extra Bass" is optional. Check how the effects sound and then configure them to your liking.
- Use the following as a guide when setting speaker sizes.

When you have completed the settings for one speaker, repeat the same procedure for all speakers to complete settings.

- 6 Press **RETURN** when setting is complete.

This completes step 2.

### STEP 3: Set the distance from the listening point

- 7 Press **Cursor** to display "Distance" and press **ENTER**.



Continues to the next page

- 8 Press **Cursor**  $\Delta$  /  $\nabla$  to select the speaker (subwoofer) that you want to configure, and press **Cursor**  $\triangleleft$  /  $\triangleright$  to set the distance.

If necessary, you can change the setting units under "Unit."

Information	Description	Setting
Unit	Switches between setting units (feet / meters).	feet (ft) / meters (m)
Front L	Front speaker L	1.0 ft to 80.0 ft (0.30 m to 24.0 m)
Front R	Front speaker R	1.0 ft to 80.0 ft (0.30 m to 24.0 m)
Center	Center speaker	1.0 ft to 80.0 ft (0.30 m to 24.0 m)
Sur. L	Surround speaker L	1.0 ft to 80.0 ft (0.30 m to 24.0 m)
Sur. R	Surround speaker R	1.0 ft to 80.0 ft (0.30 m to 24.0 m)
SWFR	Subwoofer	1.0 ft to 80.0 ft (0.30 m to 24.0 m)

When you have completed the settings for one speaker, repeat the same procedure for all speakers to complete settings.

- 9 Press **RETURN** when setting is complete.

This completes step 3.

#### STEP 4: Playback a test tone

- 10 Press **Cursor**  $\nabla$  repeatedly to display "Test Tone" and press **ENTER**.



- 11 Use **Cursor**  $\triangleleft$  /  $\triangleright$  to select "On."

A test tone plays back from the speakers as soon as you select "On." The test tone plays back in a clockwise fashion. Only speakers configured for use in procedure 5 output the test tone.

- 12 Check that the test tone is playing back and press **RETURN**.

This completes step 4.

#### STEP 5: Adjust the volume

- 13 Press **Cursor**  $\Delta$  repeatedly to display "Level" and press **ENTER**.



- 14 Use **Cursor**  $\Delta$  /  $\nabla$  to switch the speaker that is outputting the test tone, looking for speakers with a different volume level to the others.

The front panel display shows the speaker that is outputting the test tone.  
Only speakers configured for use in procedure 5 output the test tone.

Information	Speakers
FL	Front speaker L
FR	Front speaker R
C	Center speaker
SL	Surround speaker L
SR	Surround speaker R
SWFR	Subwoofer

- 15 If you find a speaker with a different volume level to the others, use **Cursor**  $\triangleleft$  /  $\triangleright$  to adjust the volume. Use Front speaker L or R as a default when adjusting volumes.

To raise the volume: Press **Cursor**  $\triangleright$ .  
To lower the volume: Press **Cursor**  $\triangleleft$ .

- 16 Repeat steps 14 and 15 to adjust the volume balance for all speakers to your preference.

- 17 Press **RETURN** when setting is complete.

Return to the previous menu.  
This completes step 5.

- 18 Repeat procedures 10-12 (step 4) to stop playback of the test tone.

- 19 Once you have completed all settings, press **SETUP** to close the Setup menu.

# Operation guide

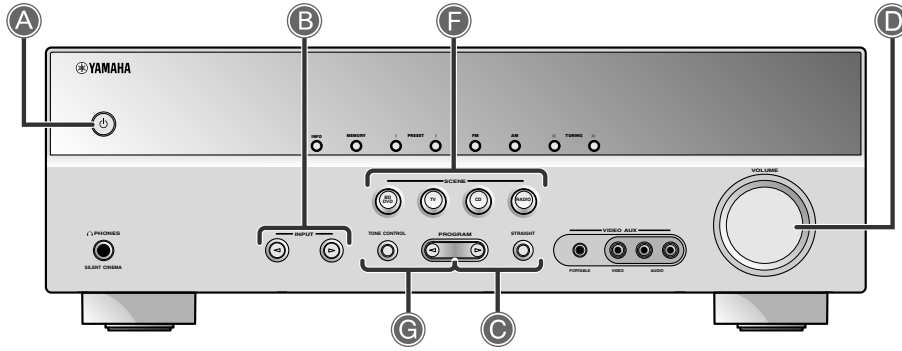

**A Switches this unit between on and standby modes**  
This unit switches between on and standby mode every time you press this key.

**B Choose an input source to listen to**  
The name of the selected input source appears on the front panel display.



**C Select sound field programs and sound decoders**

Front panel	Remote control	Description
PROGRAM	MOVIE	Selects sound field programs optimized for viewing movies, dramas, and sports.
	MUSIC	Selects sound field programs optimized for appreciating music.
	ENHANCER STEREO	Selects settings for stereo playback or enhancer for compressed audio.
STRAIGHT	SUR. DECODE	Selects surround decoders such as Dolby Pro Logic II.
	STRAIGHT	Switches to straight decoding mode for faithful reproduction of audio / video.

**D Adjusts the volume level**  
The current volume level is displayed on the front panel display.



**E Mutes the sound**  
The indicator blinks while the sound is muted.

**F Switches between input settings**  
You can switch input sources and sound field programs with a single key.

SCENE	Input	Sound field program
BD/DVD	HDMI 1	STRAIGHT
TV	AV4	STRAIGHT
CD	AV3	STRAIGHT
RADIO	TUNER	5ch Enhancer

- Pressing and holding this key allows you to store input sources/sound field programs.
- Press this key when this unit is in standby mode to switch on the unit.

**G Adjusting high/low-frequency sound (Tone control)**

- 1 Press **TONE CONTROL** to select "Treble" or "Bass."



- 2 Press **PROGRAM** ◀ / ▶ to increase the setting.

- You can set the tone control for speakers and headphones separately. Connect the headphones when adjusting the headphone tone control.
- If you set an extreme tone balance, sounds may not match those from other channels.

